

# RADIO & TELEVISION NEWS

JANUARY

1956

35 CENTS

in U. S. and Canada

*World's Leading Electronics Magazine*

## IN THIS ISSUE

**CHOOSING  
A PHONO PICKUP**

**TRANSISTORIZED  
TV ANTENNA COMPASS  
& FIELD STRENGTH METER**

**DO YOU NEED A  
PREAMP-CONTROL UNIT?**

**AN IMPROVED  
"30" CONVERTER**

**A TRANSISTOR  
R. F. FREQUENCY METER**

**THOSE TOUGH DOGS**

**PENNSYLVANIA TV TEST  
POINTS FOR 1956**

**EVOLUTION OF THE  
PHONOGRAPH**

**TV SIGNAL TRACING  
WITH A SCOPE**

**A HOME MUSIC SYSTEM  
(See Page 54)**



X-74-3367-67  
SAMUEL TABSHY  
6727 N YALE ST  
PORTLAND 3 OREG



For ALUMINIZED TUBE PERFORMANCE, *plus* EXCELLENT TUBE LIFE . . . Replace with



Thanks to LUMILAC, Raytheon Aluminized Picture Tubes provide sharper pictures, high light output and superior contrast — *plus excellent tube life*. LUMILAC, — a lacquer especially blended and used exclusively by Raytheon — is the secret of superiority. This amazing lacquer produces an extra smooth, unbroken surface for the pure aluminum coating, yet leaves no gas-producing residues which could impair cathode emission and shorten tube life.

What's more, the quality of Raytheon Aluminized Picture Tubes is safeguarded by Raytheon's great ultra-modern Cathode Ray Tube Plant in Quincy, Mass. — a plant designed and built solely for the manufacture of first quality picture tubes.

*Replace with Raytheon Aluminized Picture Tubes — they are best for you and your customers, too.*

## RAYTHEON "Lumilac" ALUMINIZED PICTURE TUBE REPLACEMENT GUIDE

RAYTHEON "Lumilac" ALUMINIZED PICTURE TUBE	REPLACES STANDARD TYPE	NECESSARY ADJUSTMENTS OR CHANGES	RAYTHEON "Lumilac" ALUMINIZED PICTURE TUBE	REPLACES STANDARD TYPE	NECESSARY ADJUSTMENTS OR CHANGES
12KP4A	12KP4	None.	21AUP4A	21AUP4	None.
	12QP4	Ground conductive coating. Remove ion trap.		21AUP4B	None.
	12QP4A	Ground conductive coating. Remove ion trap.	21AVP4A	21AVP4	None.
	12RP4	Ground conductive coating. Remove ion trap.		21AVP4B	None.
16KP4A	16KP4	None.	21EP4B	21EP4	Ground conductive coating.
	16QP4	Ground conductive coating. Change ion trap.		21EP4A	None.
	16RP4	Check conductive coating contact.	21FP4C	21FP4	Ground conductive coating.
	16TP4	Space may not be sufficient in some cases.		21FP4A	None.
	16XP4	Ground conductive coating. Change ion trap.	21YP4A	21AFP4	Ground conductive coating.
17BP4B	17BP4	Ground conductive coating.		21YP4	None.
	17BP4A	None.	21ZP4B	21ZP4	Ground conductive coating.
	17BP4C	None.		21ZP4A	None.
	17JP4	Do not exceed voltage rating.	24CP4A	24CP4	None.
17HP4B	17HP4	None.		24QP4	None.
	17HP4A	None.		24TP4	None.
	17RP4	None.		24XP4	Ground conductive coating.
17LP4A	17LP4	None.	24DP4A	24DP4	None.
	17VP4	None.	27EP4	27GP4	None.
20DP4C	20DP4A	None.		27NP4	Add filter condenser.
21ALP4A	21ALP4	None.	27RP4	27GP4	Ground conductive coating.
	21ALP4B	None.		27NP4	None.
	21ANP4	Ground conductive coating.			
	21ANP4A	Ground conductive coating.			



**RAYTHEON MANUFACTURING COMPANY**

Receiving and Cathode Ray Tube Operations

Newton, Mass. • Chicago • Atlanta, Ga. • Los Angeles, Calif.

Raytheon makes all these

Receiving and Picture Tubes, Reliable Subminiature and Miniature Tubes, Semiconductor Diodes, Power Rectifiers and Transistors, Nucleonic Tubes, Microwave Tubes

*Excellence in Electronics*



# Learn to Service TV Sets—any make or model—Quickly

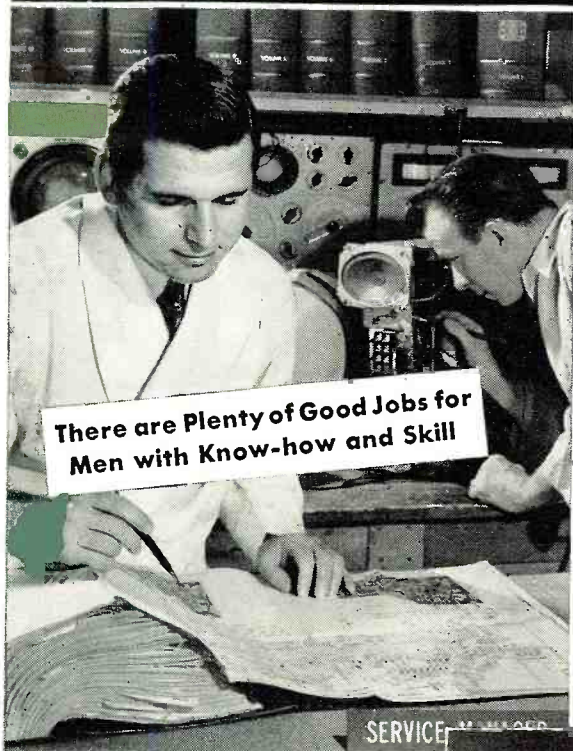

There are Plenty of Good Jobs for Men with Know-how and Skill

## New ALL PRACTICE Method trains you at home to become a Professional TV Serviceman

*You learn the time saving techniques, methods used by top TV Servicemen*

This is 100% learn-by-doing, practical training. NRI supplies all necessary equipment, all tubes, including a 17-inch picture tube; and comprehensive manuals covering a thoroughly planned program of practice. You learn how experts diagnose TV receiver defects quickly. You easily learn the causes of defects—audio and video—and how to fix them accurately.

You get actual experience aligning TV receivers, isolating complaints from scope patterns, eliminating interference, using germanium crystals to rectify the TV picture signal, adjusting the ion trap and hundreds of other valuable Professional techniques.

## UHF and COLOR Create Growing Opportunities

To cash in on the present UHF and the coming COLOR TV boom you'll need the kind of knowledge and experience NRI's Course gives. You'll get practice installing front-end channel selector strips in modern UHF-VHF receivers. You learn UHF servicing problems and their solution. Mail the coupon now. Discover how NRI's new course in PROFESSIONAL TELEVISION SERVICING meets the needs of the man who wants to get ahead in TV Servicing.

### Not for Beginners

If you have some knowledge of Radio-TV fundamentals, or have had some Radio Shop experience or some Radio school training, this course IS FOR YOU. Mail coupon today. Address National Radio Institute, Dept. 6AET, 16th and U Sts., N.W., Washington 9, D.C.

**MAIL NOW**

17" Picture Tube, Components for a TV Receiver, Scope, Signal Generator, HF Probe—all included in introductory price under \$200—Easy Terms

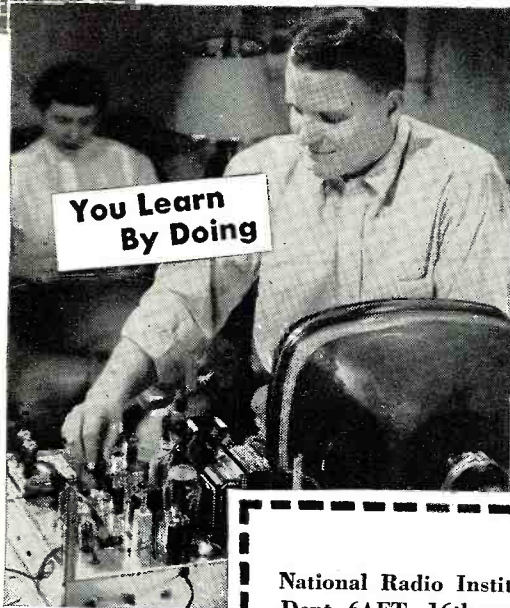

You Learn By Doing

If you want to go places in TV servicing, you will act quickly to find out what you get, what you practice, what you learn and how NRI's new course in Professional Television Servicing will help you advance through better technical knowledge and training. See pictures of equipment supplied, read what you practice in book offered FREE to ambitious men with some knowledge of Radio or TV fundamentals. Find out about this ALL PRACTICE Professional TV Servicing Course now.



## COUPON BRINGS IMPORTANT BOOK FREE

Get this book and judge for yourself how this course will further your ambition to reach the top in TV Servicing or help to build a more secure business of your own in TV. Many of tomorrow's top TV Servicemen . . . men who can service any make, any model, UHF, VHF or Color TV . . . will be graduates of this training. Mail the coupon now. There is no obligation.

National Radio Institute  
Dept. 6AET, 16th and U Sts., N.W.  
Washington 9, D.C.

Please send my FREE copy of "How to Reach the Top in TV Servicing." I understand no salesman will call.

Name.....Age.....

Address.....

City.....Zone.....State.....

APPROVED MEMBER National Home Study Council

RADIO & TELEVISION NEWS is published monthly by Ziff-Davis Publishing Company, William B. Ziff, Chairman of the Board (1946-1953), at 64 E. Lake St., Chicago 1, Ill. Entered as second-class matter July 21, 1948, at the Post Office, Chicago, Ill., under the act of March 3, 1879. Authorized by Post Office Department, Ottawa, Canada, as second-class matter. SUBSCRIPTION RATES: Radio & Television News—one year U. S. and possessions, and Canada \$4.00; Pan-American Union countries \$4.50; all other foreign countries \$5.00.



Editor and Asst. Publisher  
**OLIVER READ, D.Sc., W1FTI**  
 Managing Editor  
**WM. A. STOCKIN, B. S.**  
 Technical Editor  
**H. S. RENNE, M. S.**

Service Editor  
**CHARLES TEPPER**

Associate Editor  
**P. B. HOEFER**

Assistant Editor  
**J. JUSTER**

Television Consultant  
**WALTER H. BUCHSBAUM**

Art Editor  
**FRANK SAYLES**

Draftsman  
**J. A. GOLANEK**  
**W. K. VAHLSING**

Advertising Director  
**L. L. OSTEN**

Advertising Manager  
**MURRAY GOLDMAN**

Midwest Adv. Manager  
**JOHN A. ROMAN, JR.**

Western Adv. Manager  
**JOHN E. PAYNE**



Reg. U. S. Pat. Off.  
 Radio News Trademark Reg. U. S. Pat. Office • Television News Trademark Reg. U. S. Pat. Office.

*First in radio-  
 television-audio-electronics*

Average Net Paid Circulation 235,788

## CONTENTS

JANUARY, 1956

### EDITORIAL-INDUSTRY NEWS

For the Record.....	O. Read	8
Spot Radio News.....	Washington Correspondent	16
New TV Grants Since Freeze Lift.....		16
Electronics—Horizons Unlimited (A Guest Editorial)....	Michael Kourday	35
New G-E Color Picture Tube.....		104
New TV Stations on the Air.....		126

### HIGH-FIDELITY AND AUDIO

Choosing a Phono Pickup.....	N. H. Crowhurst	37
Do You Need a Preamp-Control Unit?.....	Burt Hines	47
A Home Music System.....		54
An Improved "3D" Converter.....	Joseph Chernof	56
Evolution of the Phonograph (Part 3).....	Oliver Read & James Riley	58
Tape Recording-Equalization (Part 5).....	Herman Burstein	66
Certified Record Revue.....	Bert Whyte	70
Better Records—A Result of Better Process.....		74
Transistorized Audio Amplifier.....		87
Tuning Eye or Tuning Meter?.....	Jan Syrjala	88
New Hi-Fi-Audio Equipment.....		114

### SERVICING

#### Television-Radio

Transistor Radios (Part 1).....	Milton S. Kiver	40
Sylvania TV Test Points for 1956.....	George C. Chernish, P.E.	50
Those Tough Dogs.....	Art Margolis	52
TV Signal Tracing With a Scope.....	Walter H. Buchsbaum	60
Mac's Service Shop.....	John T. Frye	72
A Method of Measuring High Resistance.....	J. P. C. McMath	129
Antenna News.....		138
Radio-TV Service Industry News.....		160

#### Test Equipment

Transistorized TV Antenna Compass & Field Strength Meter.....	Rufus P. Turner, K6AI	43
New Tube Tester Data.....		55
Tubeless Scope Calibrator.....	Edwin Bohr	63
A Transistorized Pulse Generator.....	E. G. Louis	64

### AMATEUR

A Low-Cost Frequency Standard.....	Paul S. Lederer	46
A Transistor R.F. Frequency Meter.....	Louis E. Garner, Jr.	68
Cliff-Dweller's Antenna.....	K. E. Hughes, W6CIS	121
A Low-Cost Crystal Marker.....	Charles H. Wood, Jr., K4CKO	122

### DEPARTMENTS

Within the Industry.....	28	Technical Books.....	135
Manufacturers' Literature.....	92	Sales Aids.....	143
What's New in Radio.....	153		

COPYRIGHT 1955

(All Rights Reserved)

**ZIFF-DAVIS PUBLISHING COMPANY**  
 WILLIAM B. ZIFF (1898-1953) FOUNDER  
 Editorial and Executive Offices  
 366 Madison Ave., New York 17, N. Y.  
 VOLUME 55 • NUMBER 1



Member  
 Audit Bureau of  
 Circulations

**SUBSCRIPTION SERVICE:** All communications concerning subscriptions should be addressed to Circulation Dept., 64 E. Lake St., Chicago 1, Ill. Subscribers should allow at least four weeks for change of address. Include your old address as well as new—enclosing, if possible, an address label from a recent issue of this magazine.

**CONTRIBUTIONS:** Contributors are advised to retain a copy of their manuscripts and illustrations. Contributions should be mailed to the New York Editorial Office and must be accompanied by return postage. Contributions will be handled with reasonable care, but this magazine assumes no responsibility for their safety. Any copy accepted is subject to whatever adaptations and revisions are necessary to meet the requirements of this publication. Payment covers all author's, contributors', and content's rights, title, and interest in and to the material accepted and will be made at our current rates upon acceptance. All photos and drawings will be considered as part of the material purchased.

**RADIO & TELEVISION NEWS**



COVER PHOTO: Home music systems are as varied as their users. This chap did as many are doing—bought part of his equipment assembled and the rest he constructed from some of the many good kits on the market now.  
 (Ektachrome by John Deetjen)

### ZIFF-DAVIS PUBLISHING COMPANY

President  
**B. G. DAVIS**

Vice-Presidents  
**H. J. MORGANROTH**  
**M. H. FROELICH**

Secretary-Treasurer  
**G. E. CARNEY**

Circulation Manager  
**M. MICHAELSON**

### BRANCH OFFICES

CHICAGO III  
 64 E. Lake St., AN 4520

LOS ANGELES (14)

Starline Center, 900 Wilshire Blvd., Mich. 9036



Here's an amazingly effective way to learn  
**TELEVISION** RADIO and  
**ELECTRONICS**  
 in spare time AT HOME... or at DTI's big Chicago training center

What will mailing the coupon below do for YOU? First, you will get . . . absolutely free . . . the valuable publication, "89 Ways to Earn Money in Television-Radio-Electronics." You'll find out about scores of exciting, good paying opportunities in this vast, billion-dollar industry—one of the largest, most promising opportunity fields in America today. Best of all, you will find out exactly how you may prepare to get into this good paying work that is so interesting . . . that enables you to start your own business almost "on a shoestring," if you prefer this to a job opportunity.

**NOW . . . get EVERYTHING you need!**

You'll also see WHY so many employers ask for DeVry graduates. You'll see that DeVry Tech provides every major training advantage you may need . . . in your spare time at home . . . or in our big million-dollar training center in Chicago. In our home program, you (1) learn-by-reading from easy-to-read, well illustrated lessons, (2) learn-by-seeing from home movies—a wonderful advantage that helps make important points picture clear, and (3) learn-by-doing from 16 shipments of Electronic parts, enabling you to work over 300 fascinating projects.

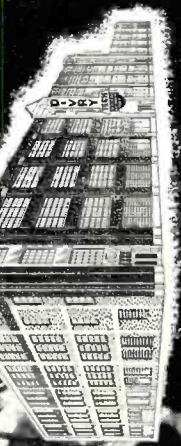

Valuable Test Equipment Helps You "Earn While You Learn"  
 As part of your home laboratory projects, you build and keep a top-quality Vacuum Tube Voltmeter and a 5-inch Oscilloscope—two of the most useful pieces of test equipment. No need to buy this expensive equipment later. Little wonder so many DeVry students tell us they are able to earn all, or a good part of the cost of their training, servicing TV and Radio equipment in their spare time.

**MODERN LABORATORIES**

If you prefer, get all your preparation in DeVry's new Chicago training center—one of the finest, best equipped of its kind. Write for details!

**EMPLOYMENT SERVICE**

Upon completing your training, you can get the full benefit of the same effective employment service that has already helped thousands of DeVry graduates to start earning good money.

**MILITARY SERVICE**

If you are subject to Military service, the information we have should be very helpful to you. Mail coupon today.

**MAIL COUPON TODAY!**

**89 WAYS TO EARN MONEY IN TELEVISION RADIO ELECTRONICS**

DeVry Technical Institute  
 4141 Belmont Ave., Chicago 41, Ill. Dept. RM-1-M

I would like complete facts including "89 Ways to Earn Money in Television-Radio-Electronics."

Name \_\_\_\_\_ Age \_\_\_\_\_  
 Street \_\_\_\_\_ Apt. \_\_\_\_\_  
 City \_\_\_\_\_ Zone \_\_\_\_\_  
 6 State \_\_\_\_\_

DTI's Training is available in Canada



**DeVry**  
**TECHNICAL INSTITUTE CHICAGO 41, ILLINOIS**  
 "One of America's Foremost Television Training Centers"  
 Formerly DeFOREST'S TRAINING, INC.



**TRUE HORNS** ... based on corner horn principles of the Klipschorn, high fidelity's standard of performance ...

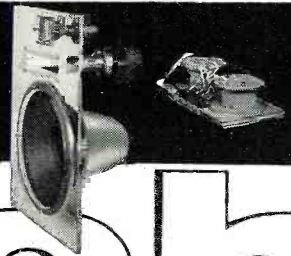

# Klipsch

## Rebel

corner-folded  
horns

TRADEMARK

The REBEL 3 HORN



The KR-3U

factory-assembled and finished in fine woods ...

**\$126.00**

The KR-3U

assembled, ready-to-finish

**\$84.00**

The K-3

kitform of the KR-3

**\$54.00**

Quite simply, the Cabinart-Rebel speaker horns offer reproduction cleaner and truer to the original than conventional reflexed or resonated boxes. The Rebel 3, largest of the series, extends low-end response down nearly to 30 cycles. The smaller Rebels offer comparable performance with no compromise in overall quality. Using the same principles of mirror images produced by room walls at a corner, as does the Klipschorn, Rebels offer the maximum possible performance per cubic foot, per dollars worth of horn and per driving element.

## and Ortho-speaker systems

ORTHO describes a new series of multiple-unit speaker systems designed specifically for the Rebel horns. Each is a 3-way 3-speaker unit. Each includes a remarkable mid-range horn and crossover network of Klipsch design and manufacture. Write for additional information on these unusual Cabinart-Rebel speaker systems.



Assemble your own Rebel horn or Rebel-Ortho speaker system. If doing it yourself is half the fun, you'll only need a screwdriver to assemble any of three Rebel horn kits. If you already own a Rebel, add the Rebel-Ortho speaker system kit designed for your Rebel!

The REBEL 4 HORN  
factory-assembled and finished in fine woods

KR-4/12  
for 12" woofers  
**\$69.00**

KR-4/15  
for 15" woofers  
**\$87.00**

The K-12  
kitform of the KR-4/12  
for 12" woofers  
**\$36.00**

The K-15  
kitform of the KR-4/15  
for 15" woofers  
**\$42.00**

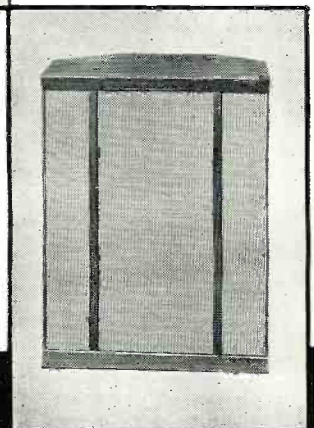

The REBEL 5 HORN



KR-5

factory-assembled and finished in fine woods

**\$48.00**

KR-5 U

assembled, ready-to-finish

**\$33.00**

KR-5 P

in leatherette carrying case ...

**\$48.00**

Slightly higher west and south

# Cabinart



Cabinart is the exclusive, licensed manufacturer of Klipsch-designed Rebel horns and Rebel Ortho speaker systems.



WRITE FOR COMPLETE CATALOG

a division of G & H Wood Products Co., Inc.

99 North 11th St., Brooklyn 11, N. Y.



# An Excellent Way to Test Your Understanding of Music

Will you accept **WITHOUT CHARGE** the

Music-Appreciation Recording of

## *Brahms'* VIOLIN CONCERTO IN D MAJOR

WALTER GOEHR, conducting the LONDON SYMPHONY ORCHESTRA • *Endre Wolf*, violinist

ON TWO RECORDS (a 12-inch and a 10-inch disc)\*



First play the 12-inch PERFORMANCE record and see how much—and what—you hear in it . . .



Then play the 10-inch ANALYSIS record—and see how much you may have been missing

**\*IMPORTANT, PLEASE NOTE:** Unlike most MUSIC-APPRECIATION RECORDS (see below), this recording, because of the length of the Brahms' concerto, is on two records—a 12" disc with the uninterrupted performance only, and a 10" disc presenting the analysis, written and conducted by Thomas Scherman, Musical Director of MUSIC-APPRECIATION RECORDS.

### SPONSORED BY THE BOOK-OF-THE-MONTH CLUB

THIS NEW IDEA is designed for those who enjoy good music but who are aware, too often, that they do not listen to it with complete understanding and appreciation. There is no doubt about the reason: most of us are not properly primed about *what to listen for*. MUSIC-APPRECIATION RECORDS meet this need—for a fuller understanding of music—better than any means ever devised. This enjoyable form of self-education is comparable to the Music Appreciation courses given in many universities.

**YOU SUBSCRIBE BUT TAKE ONLY THE RECORDS YOU WANT . . .** A new MUSIC-APPRECIATION RECORD is issued—for subscribers only—every month. You receive a descriptive Announcement about each record, written by the noted composer and music commentator, Deems Taylor. After reading this Announcement you may take the record or not. *You are not obligated to take any specified number of records.* And you may stop the subscription at any time!

**TWO TYPES OF RECORDS . . .** All MUSIC-APPRECIATION RECORDS are high-fidelity, long-playing records of the highest quality—33 $\frac{1}{3}$

R.P.M. on Vinylite. They are of two kinds: first, a so-called Standard Record—a *twelve-inch* disc—which presents the uninterrupted performance on one side, featuring orchestras and artists of recognized distinction, and on the other side an illuminating analysis of the music with the themes and other main features played separately, with running explanatory comment, so that you learn what to listen for. This standard record is sold for \$3.60 to subscribers only. When the selection, because of its length, requires two records, as in the case of Brahms' *Violin Concerto*—a 12-inch record giving the performance and a 10-inch record giving the analysis—the price is \$4.90 for the two. (A small charge is added to the prices above to cover postage and handling.)

**TRY A ONE-MONTH SUBSCRIPTION — WITH NO OBLIGATION TO CONTINUE . . .** Why not make a simple trial, to see if these records are as pleasurable and as enlightening as you may anticipate? The *Brahms* recording will be sent to you at once—*without charge*. You may end the subscription immediately after hearing this recording, or you may cancel any time thereafter. In any case, the gift recording is yours to keep.

PLEASE RETURN ONLY IF YOU HAVE A 33 $\frac{1}{3}$  R.P.M. RECORD PLAYER

MUSIC-APPRECIATION RECORDS R38-1  
c/o Book-of-the-Month Club, Inc.  
345 Hudson Street, New York 14, N. Y.

Please send me at once the Music-Appreciation recording of *Brahms' Violin Concerto in D major*, without charge, and enroll me as a Trial Subscriber to MUSIC-APPRECIATION RECORDS, with the privilege of canceling at any time. I understand that, as a subscriber, I am not obligated to buy any specified number of records, but may take only those I want. Also, I may cancel my subscription after hearing the first recording, or any time thereafter at my pleasure, but the gift offer is free in any case.

Mr. }  
Mrs. } .....  
Miss } (PLEASE PRINT)

ADDRESS.....

CITY..... Postal Zone No. .... STATE.....  
(if any)

MAR 60



Thrill to  
"silk-and-diamond"  
highs\*

12 NOTES  
ABOVE  
HIGH C,  
AND UP

**E-V**  
T 35 Super Smooth

\*Smooth as silk, brilliant as diamonds, the highest octaves you can hear are realistically yours, with an E-V T35 in your high fidelity music installation. This new, very-high-frequency tweeter takes over from 3500 cps to beyond audibility . . . provides 180° dispersion. Is easily installed, along with recommended X36 crossover and AT37 level control.

T35	List \$55.00	Audiophile Net	\$33.00
T35B	List \$35.00	Audiophile Net	\$21.00
X36	List \$14.00	Audiophile Net	\$ 8.40
AT37	List \$ 6.00	Audiophile Net	\$ 3.60

The T35B — for lower powered systems and existing quality AM-FM radio or radio-phonographs, finished in flat matte black. Requires only X36 to attach to music system. Impedance 16 ohms. Shipping weight 2 lbs.

Beautiful T35 Accessory Enclosure

The Piccolino for either the T35 or the T35B. Styled in gleaming tropical mahogany or lustrous Korina blonde. List \$15.00 Audiophile net \$9.00.

The Piccolino, complete with Super-Sonax, X36 crossover and AT37 level control wired and ready to connect to your music system: with T35 List \$90.00 Audiophile Net \$54.00; with T35B List \$70.00 Audiophile Net \$42.00.

Prove the performance of the T35 to yourself!

You hear the difference with this T35 demonstrator. With a flip of the switch you bring in or cut out the T35. Visit your E-V distributor to conduct this amazing test personally.

Today—write for Bulletin 194 and where to buy.

**Electro-Voice** ELECTRO-VOICE, INC.  
BUCHANAN, MICHIGAN

*For the* **RECORD.**  
BY THE EDITOR

THE PART-TIME SERVICE TECHNICIAN

THE daily mail is seldom received without at least one letter from a "professional" service technician in which he condemns the "part time" operator who encroaches on his business. Too often these writers fail to remember that, in many cases, they themselves "cut their eye teeth" in radio service by engaging in part time maintenance of sets in their home neighborhoods.

These men, particularly in the early days, did not have a clientele which could support a full-time operation and it was necessary to earn a basic living in other fields of endeavor. We speak from our own experience in this respect.

Radio and television servicing is in no way different from many of the other service professions in which an excessive amount of capital is not needed to set up a business. It is certainly common knowledge that many Certified Public Accountants, commercial artists, professional engineers, etc., work for companies full time and, at the same time, build up a clientele of their own for future independent operations. This is an accepted practice in these respective trades. Why should it be frowned upon in TV servicing?

One objection to the part-time service operator brought against him by the "professional" is that he charges less than the full-time shop can for the same job. His overhead is extremely low since he most often operates out of his home or cellar, and he buys parts for the same price as the full-time shop, and charges less.

This, the "professional" charges, is unfair competition. However true this may be, the fact remains that if run properly a "downtown," full-time store has competitive advantages that the part-time operator cannot hope to attain. The store in the business section has prestige and location to begin with. What the operator does with these factors is a measure of his astuteness as a business man. No amount of griping about unfair competition will take the place of good and fair business practices.

Many times, a customer will take his set to a part-time operator because he feels that here he will get individual attention, that his set will not be part of an assembly-line service operation, and his complaints will not be brushed off with "the set is pretty old anyway, so what can you expect?" Because the part-time operator is anxious to build

up a clientele, which means repeat business and recommendations to others, he will often spend some time adjusting the set and perhaps even cleaning it to bring it up to peak performance. How many established service shops follow this practice?

As far as charges are concerned, a professional shop with its experienced personnel should be able to handle average service jobs at least twice as fast as the part-time operator. It should take less time for the experienced bench man to diagnose a trouble to its source and, since the shop has a greater stock of parts on hand, less time for him to repair the trouble than his part-time counterpart. On the basis of this, the shop's charge should not be much greater than the part-time operator's if the latter is also working in a business-like fashion. And herein lies the key as to how the "professional" service technician and business operator can benefit himself as well as the servicing industry as a whole.

Many independent service operators all over the country have joined together in service associations for their mutual benefit. Where they are run by imaginative leaders and where they consist of an interested and alert membership, these trade associations have been able to improve the reputation of the service industry in the community as well as improve the business procedures of the members themselves. Why doesn't the service association in any particular locality invite the conscientious part-time service operators to join, perhaps as associate members, so that they can derive the benefits of associating with experienced businessmen. At the same time, the "professional" can impress upon the part-timer the importance of adequate pricing and the danger to his future development of cut-rate pricing, as many part-time operators have learned to their regret. The part-time operator must be made aware of the fact that once he undercuts and sells his services short, it will always be expected of him, no matter how high his overhead goes after he has started full-time operations.

And if it is his intention to go into full-time service operations when he has built up a clientele and reputation, the part-time operator must start at the beginning to establish a reputation for fairness and technical efficiency without which he can never grow. . . . O. R.



free

# ALLIED'S 1956 value-packed 324-PAGE CATALOG

the only **COMPLETE** catalog  
for everything in TV, Radio, Hi-Fi  
and Industrial Electronics

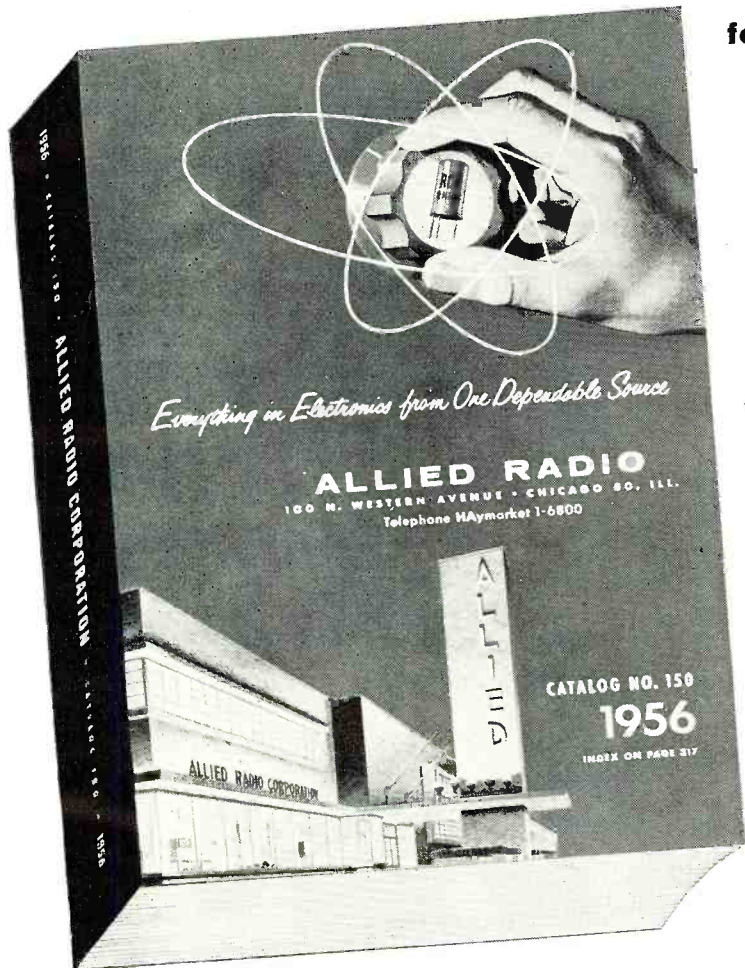

Get ALLIED's 1956 Catalog—it's *complete*, up-to-date—324 pages packed with the world's largest selection of quality electronic equipment at lowest, money-saving prices. Get *every* buying advantage at ALLIED: fastest shipment, expert personal help, lowest prices, assured satisfaction. Send today for your **FREE** copy of the big 1956 ALLIED Catalog.

## World's Most Complete Stocks

- Latest Hi-Fi Systems and Components
  - P.A. Systems and Accessories
- Recorders and Supplies • TV Tubes, Antennas, Accessories • Amateur Receivers, Transmitters, Station Gear
- Specialized Industrial Electronic Equipment • Test and Lab Instruments
- Huge Listings of Parts, Tubes, Transistors, Tools, Books

**Featuring Super-Value Knight-Kits—**  
top quality electronic equipment  
in precision-designed kit form  
**BUY DIRECT AND SAVE**

### EASY-PAY TERMS

Use our liberal Easy Payment Plan—only 10% down, 12 months to pay—no carrying charges if you pay in 60 days. Available on Hi-Fi and P.A. units, recorders, TV chassis, test instruments, kits, Amateur gear, etc.

### HI-FI SPECIALISTS

To keep up with the latest and best in High Fidelity, look to ALLIED. Count on us for *all* the latest releases and largest stocks of Hi-Fi equipment. We specialize, too, in TV supply—and are foremost in the field of Builders' Kits.

free

send for the leading  
electronic supply guide

**ALLIED RADIO CORP., Dept. 1-A-6**  
100 N. Western Ave., Chicago 80, Ill.

Send **FREE** 324-Page 1956 ALLIED Catalog.

Name \_\_\_\_\_

Address \_\_\_\_\_

City \_\_\_\_\_ Zone \_\_\_\_\_ State \_\_\_\_\_



## ALLIED RADIO

World's Largest Electronic Supply House

January, 1956



# NOW! PHOTOFACT BRINGS YOU EXTRA SCHEMATIC COVERAGE

you get immediate coverage on leading receivers just as soon as they hit the market!

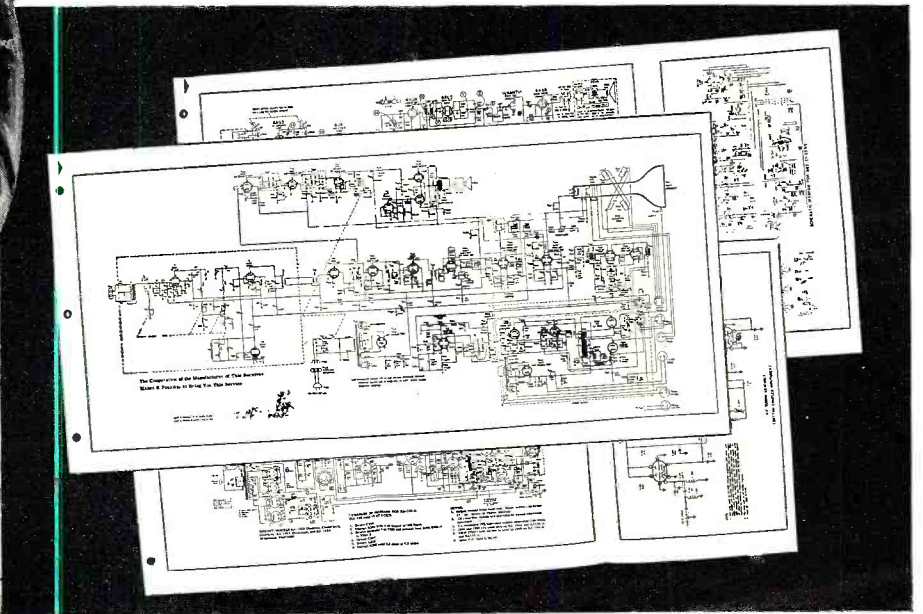

**IT'S AN "EXTRA" SERVICE—  
IN ADDITION TO REGULAR COVERAGE—  
AT NO EXTRA COST TO YOU**

The January issues of Sams' PHOTOFACT contain the first of a series of schematic diagrams covering the nation's top manufacturers' new model releases. Look for PHOTOFACT Sets 302, 303, and 304 at your Parts Distributor today! See for yourself how PHOTOFACT keeps you current with the present output of new TV and Radio Models. Be sure to enter your "standing order" for each new monthly release of Sams' PHOTOFACT Sets—they'll put you out ahead in service work.

**remember—you get the world's finest service data —  
you get it fastest in PHOTOFACT**

**HOWARD W. SAMS & CO., INC., 2203 E. 46th St., Indianapolis 5, Indiana**

**RADIO & TELEVISION NEWS**



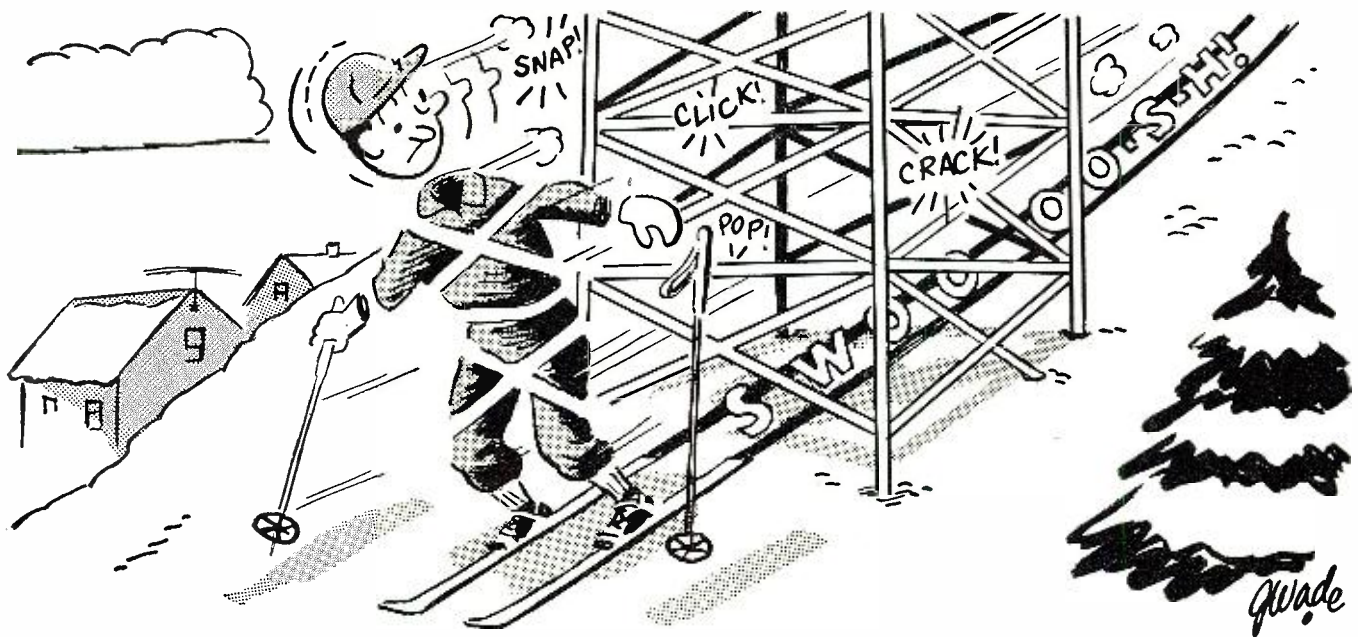

## NEW HAM GEAR

Don't go to pieces because you haven't been able to afford that ham equipment you have been dreaming about. A Walter Ashe "Surprise" trade-in allowance on your used (factory-built) test or communications equipment will go a long way towards putting that new gear into your shack. Get your trade-in deal working right now. Use the handy coupon.

**NATIONAL NC-98**  
Less speaker  
Net \$149.95

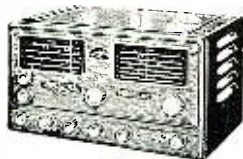

**HALLICRAFTERS SX-100**  
Less speaker. Net \$295.00



**JOHNSON VIKING RANGER**  
Transmitter-Exciter Kit  
Net \$214.50  
Wired and tested  
Net \$293.00

## SHORT OF CASH?

So are we. We've got over \$75,000 worth of first class used receivers and transmitters in stock. No junk or cheap sets. We need cash to build up our stock of new equipment **RIGHT NOW**. Here's your chance to buy the best on the market for less than you would pay for so-called low price new gear

All items have been thoroughly checked by our service department and will meet original manufacturer's specifications. Please list a first and second choice if possible. 20% deposit required on C.O.D. orders. Wire, write, phone, or use the handy coupon today.

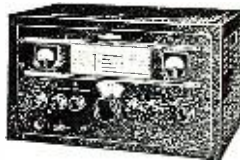

**COLLINS 32V2**



**NATIONAL HRO-60**



**LYSCO 600\***

COLLINS 32V1	\$ 224.50
COLLINS 32V2	299.50
COLLINS 32V3	449.50
COLLINS 75A1 w/s	249.50
COLLINS 75A2 w/s	299.50
COLLINS 75A3 w/s	369.50
HALLICRAFTERS SX-88	449.50
HAMMARLUND HQ-129X w/s	124.50
NATIONAL HFS with P.S.	69.50
NATIONAL HRO-50	199.50
NATIONAL HRO-60	324.50
NATIONAL NC-183D w/s	224.50

### ATTENTION NOVICES!

These versatile transmitters use a crystal while you are a novice and a built-in VFO when you get your general. Versatile? Man, they're sensational and at the hottest price in the country. Our competitors will junk theirs when they see how cheap we're selling them. Steal 'em while you can!

<b>LYSCO 600</b>	\$ 34.50
<b>LYSCO 600S</b>	59.50

WALTER ASHE RADIO COMPANY  
1125 Pine Street, St. Louis 1, Mo.

RN-1-56

Rush my order for used equipment as follows:

(1st Choice).....

(2nd Choice).....

Remittance for \$..... is enclosed.

Send free list of additional used equipment bargains.

Send new free 1956 Walter Ashe catalog.

Rush "Surprise" Trade-In offer on my.....

for.....

(show make and model of new equipment desired)

Name.....

Address.....

City..... Zone..... State.....

WRITE FOR FULL INFORMATION

ABOUT OUR TIME PAYMENT PLAN

All prices f. o. b. St. Louis • Phone CHestnut 1-1125

**Walter Ashe**  
**RADIO CO.**  
1125 PINE ST. • ST. LOUIS 1, MO.



# FIX ANY TV or



## These 2 Great Ghirardi Books bring you the kind of PROFESSIONAL TRAINING THAT REALLY PAYS OFF!

### SAVE \$1.25!

Make your service library complete! Have the needed data at your fingertips WHEN YOU NEED IT! If broken into "lessons" and sent to you as a "course," you'd regard this new Ghirardi training as a bargain at \$100 OR MORE! Instead you buy BOTH big books at the bargain price of only \$12.00 (you save \$1.25!)



A. A. Ghirardi  
More servicemen have trained from Ghirardi books than any other books or courses of their kind!

Let these two up-to-the-minute Ghirardi books make it easy for you to handle ALL types of AM, FM and Television receiver service by the very best and latest methods! Learn to handle jobs faster, better . . . and with less testing! Whether you're a service beginner or an experienced technician you'll find the speedy, professional methods that are so clearly explained can give BOTH your service efficiency and your earnings a big boost!

Almost 1500 pages and over 800 big, clear pictures and diagrams explain EVERY troubleshooting and repair operation so simply it's next to impossible to go wrong. Books are sold separately at prices indicated. Better yet, you can save \$1.25 by buying both together! Send no money. Practice from these great books for 10 full days FREE. Mail coupon today to Rinehart & Co., Inc., Dept. RN-16, 232 Madison Ave., New York 16, N. Y.

### COMPLETE TRAINING FOR BETTER RADIO-TV SERVICE JOBS!

#### Radio & Television Receiver

## 1 Circuitry & Operation

by Ghirardi & Johnson  
669 pages, 417 clear illustrations, \$6.50

It's lots easier to repair ANY radio or television set when you know all about its circuits and just why and how each one works! You locate troubles in much less time and with less testing. You repair them faster, better—more profitably! That's why *Radio & Television Receiver CIRCUITRY AND OPERATION* is invaluable to servicemen who want to be well equipped to handle today's complicated receivers! First it gives a complete understanding of basic circuits and their variations. It teaches

you to recognize each one quickly. Then it shows how to eliminate useless testing and guesswork in making repairs.

Throughout, this book gives you the kind of above-average training that takes the "headaches" out of servicing—the kind that fits you for the better-paid jobs. Covers all basic circuits used in modern TV and radio as well as phono pick-ups and record players.

Sold separately for \$6.50—or see big MONEY-SAVING OFFER.

#### Radio & Television Receiver

## 2 Troubleshooting & Repair

by Ghirardi & Johnson  
822 pages, 417 clear illustrations, \$6.75

Backed by the how-to-do-it methods and procedures so clearly explained in this big book, you can breeze through television and radio service jobs easier and faster than you may have thought possible!

Throughout its 822 pages, *Radio & Television TROUBLE-SHOOTING AND REPAIR* is an amazingly complete, how-to-do-it guide to professional service methods . . . the kind that help you handle jobs lots faster and make more money doing it!

For beginners, this big book is an easily understood course in locating troubles fast and repairing them r-i-g-h-t. For ex-

perienced servicemen, it is a quick way to "brush up" on specific jobs; to develop better methods and shortcuts; or to find fast answers to tough service problems. Modern troubleshooting is clearly explained—from quick "static" tests to dynamic signal tracing and all the rest. Special hard-to-fix troubles are fully covered. Step-by-step charts demonstrate exactly what to do on different operations. A big, television section includes everything you need to know for fast, accurate work on any TV receiver model or make.

Sold separately for \$6.75 or see MONEY-SAVING COMBINATION OFFER.

## SAVE MONEY ON INSTRUMENTS!



**BASIC ELECTRONIC TEST INSTRUMENTS**  
254 pages,  
171 illus.,  
Price \$4.00

Work better with fewer instruments—get more work out of your old ones

Here, at last, is an instrument book especially for servicemen, amateurs and experimenters!

Basic Electronic Test Instruments helps you work better and faster with fewer instruments; shows how to increase the usefulness of old instruments; how to choose the right instrument for each job; how to understand instrument readings and put them to practical use; how to avoid buying unnecessary instruments . . . and lots more.

Over 60 instruments from the old standbys to the very latest ones are fully described and explained. Work-saving shortcuts are outlined.

Included are complete details on simple meters for current and voltage; ohmmeters and V-O-M's, V-T voltmeters; power meters; impedance meters; capacitor checkers; inductance checkers; special-purpose bridges; oscilloscopes; R-F test oscillators; signal generators; audio test oscillators; R-F and A-F measuring devices; signal tracers; tube testers and many others.

This handy book is a complete training course in the latest instruments including grid-dip oscillators, TV sweep and marker generators, TV linearity pattern generators, square wave generators, distortion meters, etc. Dozens of time-saving "tricks" help you put old instruments to new uses.

Check Basic Electronic Test Instruments in coupon for 10-day FREE trial.

## BE AN EXPERT ON MAGNETIC RECORDING!

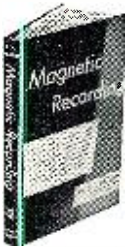

**MAGNETIC RECORDING**  
by S. J. Begun  
242 pages, 146 illustrations  
Price \$5.00

This how-to-do-it book makes it easy to specialize in one of the fastest-growing electronic fields

There's a real future for men who specialize in the fast-growing field of magnetic recording in any of its many branches!

From high fidelity sound to broadcasting, to sound movies, industrial communications, secret communications (speech scrambling), amateur radio, industrial sound and noise measurements and many others, magnetic recording is now an important factor. This book, *Magnetic Recording*, by one of the nation's acknowledged experts, clearly explains all details of the art.

### A COMPLETE GUIDE TO RECORDING METHODS AND EQUIPMENT

First you get a clear understanding of every phase of wire and tape recording . . . from basic acoustic and magnetic theories to components, equipment and circuits in present day use. Subjects include Acoustic Factors; Magnetism; Magnetic Recording Theory and Practice; System Components; Magnetic Recording Equipment; Magnetic Recording Applications; Instrumentation and Recording Measurements; The Magnetic Phonograph, and many more.

Read it 10 full days at our risk. Order *Magnetic Recording* in coupon.

## SHORT CUT TO TELEVISION REPAIRS

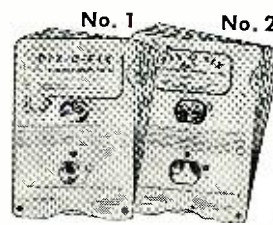

**PIX-O-FIX TV TROUBLE FINDER GUIDES**  
Only \$2 for the two

Eliminate useless testing . . . Fix sets twice as fast!

Just turn the dial of the handy, pocket-size Ghirardi & Middleton PIX-O-FIX TV Trouble Finder Guide. When the picture in the PIX-O-FIX window matches the screen image on the television set you're repairing . . . presto! . . . you've got your clue.

PIX-O-FIX then shows the causes of the trouble. Next it indicates the exact receiver section in which the trouble has probably happened. Then it gives step by step repair instructions.

The two PIX-O-FIX units No. 1 and No. 2 cover 47 different television troubles . . . just about anything you're likely to be called on to fix. No. 1 identifies 24 of the most common troubles and gives 192 causes and 253 remedies for them. No. 2 covers 23 more advanced troubles not included in No. 1. Together, they are a comprehensive guide to quick "picture analysis" servicing of any TV set . . . AND THE PRICE IS ONLY \$2.00 for the two. Money refunded if you are not more than satisfied. Specify PIX-O-FIX in coupon.

USE COUPON FOR 10-day Free Trial!



# RADIO EVER MADE

**FAST!  
EASY!  
R-I-G-H-T!**

## Cash in on HIGH-FI SERVICE and BUILDING



**HIGH FIDELITY TECHNIQUES**  
By John H. Newitt  
494 pages,  
203 illus.  
Price \$7.50

**A complete guide to better High Fidelity methods and results**

Get better results from "Hi-Fi" by having all the facts and latest ideas at your fingertips!

This big book brings you complete data on modern sound reproduction methods and equipment. It shows how to get better results at lower cost; how to build your own; how to service hi-fi equipment; discusses all details of components; compares different methods—AND IS CRAMMED FULL OF HOW-TO-DO-IT TIPS AND IDEAS.

Here are just a few of the many subjects! How to get the right hi-fi equipment for your needs; Hi-fi versus P.A. type speaker; Loud-speaker construction and performance; Adjusting bass-reflex cabinets; Reducing distortion; Getting rid of "hang-over"; Selecting a woofer-tweeter; Sound-proofing materials; All about output transformers; Special hi-fi circuits; Ways to suppress noise; Negative feedback and how to use it; Amplifier construction hints; Minimizing tuner distortion; Avoiding chatter; Limiter-discriminator vs. ratio detector FM circuits; Avoiding record wear; Tips for custom builders; Bass-reflex charts; Acoustical horn design data; special installation problems; pre-amps and equalizers; pick-up resonance; a novel horn system . . . and literally dozens of other subjects.

Order *High Fidelity Techniques* in coupon today for 10-day FREE trial!

## Here's How to Get Started in RADIO-ELECTRONICS!

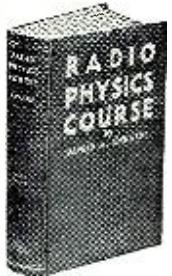

**RADIO PHYSICS COURSE**  
by Ghirardi  
372 pages,  
508 illus., 856  
self-test questions  
Price only \$6.50

**More service experts got their basic training from this big book than any other of its type!**

Here's basic training you can really understand—written by A. A. Ghirardi who has probably trained more service experts than any other man living today! From start to finish, it is practical training that can help fit you for a BIG PAY job in any branch of radio-television-electronics work.

Ghirardi's RADIO PHYSICS COURSE is the oldest book of its kind—and still a best seller BECAUSE IT IS SO AMAZINGLY CLEAR

AND COMPLETE. You can understand it, even without any previous radio or TV training!

### 36 COURSES IN ONE!

Starts with Basic Electricity. Then it takes you step by step through the entire field from basic circuits, components, instruments, etc. to their final application in radio-electronic equipment. You can buy newer, costlier training—but you can't buy better training at anywhere near the price. Ask the men who know!

Order *RADIO PHYSICS COURSE* in coupon.

## DON'T THROW OLD RADIOS AWAY!

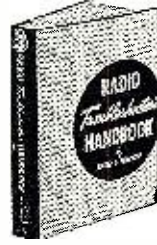

**Covers every model made by 202 mfrs. from 1925 to 1942**

**Here's the data you need to fix old sets in a jiffy**

Just look up the how-to-do-it data on that old radio you want to fix!

Four times out of 5, this giant, 3 1/2-pound, 744-page Ghirardi **RADIO TROUBLESHOOTER'S HANDBOOK** tells what is likely to be causing the trouble . . . shows how to fix it. No useless testing. No wasted time. Using it, even beginners can easily fix old sets which might otherwise be thrown away because service information is lacking. With a

few simple repairs, most of these old sets can be made to operate perfectly for years to come.

### THE ONLY GUIDE OF ITS KIND! Cuts service time in half!

Included are common trouble symptoms and their remedies for over 4,800 models of old home, auto radios and record changers. Airline, Apex, Arvin, Atwater Kent, Belmont, Bosch, Brunswick, Clarion, Crosley, Emerson, Fada, G-E, Kolster, Majestic, Motorola, Philco, Pilot, RCA, Silvertone, Sperton, Stromberg and dozens more. Includes hundreds of pages of invaluable tube and component data, service short cuts, etc.

Specify *RADIO TROUBLESHOOTER'S HANDBOOK* in coupon. Price only \$6.50. 10-day trial.

## Here's everything you need to know ABOUT OSCILLOSCOPES!

Oscilloscopes are "gold mines" if you learn to use them fully on every job. THIS BIG BOOK TEACHES YOU HOW!



**BIG NEW EDITION JUST OUT!**

Here, in a brand new 2nd edition, is THE book that really shows you how to use oscilloscopes!

Clearly as A-B-C, **MODERN OSCILLOSCOPES AND THEIR USES** gets right down to "brass tacks" in telling you exactly when, where and how. You learn to locate either AM or FM radio or television troubles in a jiffy. Even tough realignment jobs are made easy. No involved mathematics! Every detail is clearly explained—from making connections to ad-

justing circuit components and setting the oscilloscope controls. And you learn to analyze patterns fast and RIGHT!

Includes latest data on use of scopes in color TV, industrial electronics, teaching . . . even in atomic energy work. Over 400 pages and over 400 clear pictures. Dozens of pattern photos make things doubly clear. Price \$6.50.

Practice 10 days free. Order *MODERN OSCILLOSCOPES* in coupon.

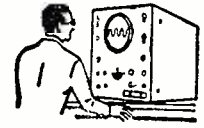

Oscilloscope experts get the BIG PAY jobs!



**LICENSE MANUAL for Radio Operators**  
by J. R. Johnson (W2BDL)

A complete, practical study guide for getting your "ticket" as a commercial operator

## Now! PASS FCC LICENSE EXAMS easier! faster!

**ONLY \$5.00**  
No lessons to wait for

Train for big pay in communication's most interesting jobs

Here, at last, is a guide to FCC License Examinations . . . written so you can easily understand AND REMEMBER it. Covers ALL EIGHT exam elements . . . not just some of them. Reviews almost 2200 typical exam questions with straight-to-the-point answers. Includes full data on the recent changes in examination elements 1 and 2. (Many folks do not even know these changes exist!) Covers all necessary examination data from electrical-radio fundamentals to navigation and related subjects. Anyone who has basic radio training will find Johnson's **LICENSE MANUAL** the ideal training book for making this all-important step ahead in his career! Price only \$5.00. Use coupon.

## TRY ANY BOOK 10 DAYS FREE!

Dept. RN-16, Rinehart & Company, Inc.,  
232 Madison Ave., New York 16, N. Y.

### Check here for MONEY-SAVING COMBINATION OFFER

. . . on Ghirardi's Radio & TV Receiver **CIRCUITRY AND OPERATION**, and Radio & TV Receiver **TROUBLESHOOTING AND REPAIR**. Price only \$12.00 for the two books plus postage. (Regular price \$13.25 . . . you save \$1.25). Payable at rate of \$3 after 10 days and \$3 a month for three months until \$12 has been paid. If not satisfactory, return books in 10 days and owe nothing.

### Check here to order INDIVIDUAL BOOKS

- Radio & TV Receiver **CIRCUITRY & OPERATION** . . . \$6.50
- Radio & TV Receiver **TROUBLESHOOTING & REPAIR** . . . \$6.75
- BASIC ELECTRONIC TEST INSTRUMENTS** . . . \$4.00
- MAGNETIC RECORDING** . . . \$5.00
- PIX-O-FIX TROUBLE-FINDER GUIDES (Nos. 1 and 2)** . . . \$2.00
- HIGH FIDELITY TECHNIQUES** . . . \$7.50
- MODERN OSCILLOSCOPES AND THEIR USES** . . . \$6.50
- RADIO TROUBLESHOOTER'S HANDBOOK** . . . \$6.50
- RADIO PHYSICS COURSE** . . . \$6.50
- LICENSE MANUAL for Radio Operators** . . . \$5.00

If cash is sent with order, we pay postage—same 10 day return privilege. Otherwise, postage is extra.

To order **OUTSIDE U.S.A.**—Special combination offer, \$13.00 for both books. For all other books, add 50c each to above prices for handling through customs, etc. Sold for cash only. Any book may be returned in 10 days and money will be refunded.

Name . . . . .  
Address . . . . .  
City, Zone, State . . . . .

RINEHART BOOKS ARE SOLD BY LEADING BOOK STORES



# The "K.O." is Fantastic!

Features the highest front-to-back ratios ever recorded for any TV antenna:

- **Low band:** from 20:1 to 50:1 relative VOLTAGE.
- **High band:** Up to 13:1 relative VOLTAGE.
- **High gain:** Low band, 7 to 9 DB. High band, 8.5 to 10.5 DB. (Single bay figures). Balanced for COLOR.

**Ends co-channel interference!**  
**Knocks out "Venetian Blinds"!**

Channel Masters "K.O." puts an INVISIBLE BARRIER in the path of rear signals, preventing co-channel interference. The "K.O." is completely preassembled with time-saving "Snap-Lock" Action. 100% aluminum.

LICENSED BY KAY-TOWNES ANTENNA CO., ROME, GA.

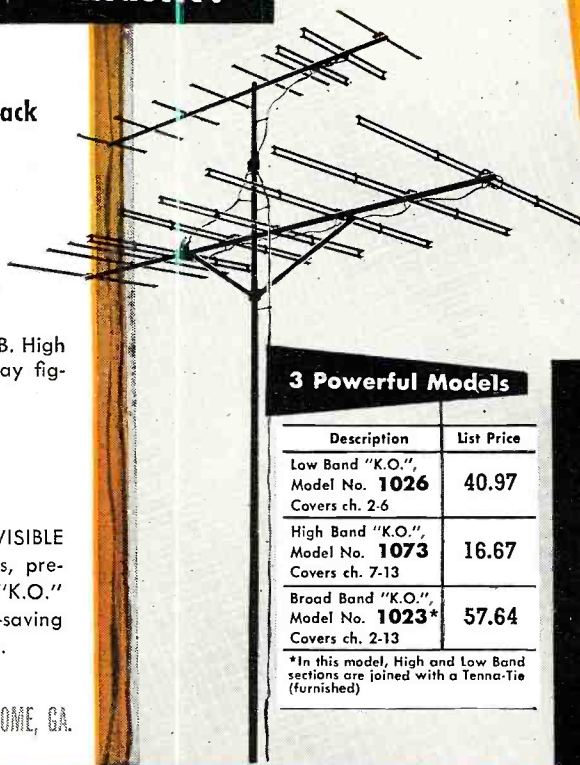

### 3 Powerful Models

Description	List Price
Low Band "K.O.", Model No. <b>1026</b> Covers ch. 2-6	40.97
High Band "K.O.", Model No. <b>1073</b> Covers ch. 7-13	16.67
Broad Band "K.O.", Model No. <b>1023*</b> Covers ch. 2-13	57.64

\*In this model, High and Low Band sections are joined with a Tenna-Tie (furnished)

**New Antennas!**

**New Accessories!**

# CHANNEL MASTER

now provides you

New expanded ACCESSORIES program! Channel Master now becomes the first and only manufacturer in the industry that can supply you with everything you need for an antenna

## The <sup>new</sup> Super Fan

- "Super-Sembled"!
- Re-designed!
- Better than ever!

Channel Master's Super Fan is the original fan antenna. Famous for its superb quality, it has been in continuous demand for six years. Millions are in current use.

- Assembles with NO HARDWARE or tightening.
- Massive, heavy-duty, molded fan head. Unaffected by moisture and extreme temperatures.
- Reinforced elements. External sleeves prevent breakage.

Desc.	Seamless		Butted	
	Model No.	List Price	Model No.	List Price
1-Bay	313A	\$10.42	713A	\$ 8.19
2-Bay	313-2A	22.22	713-2A	17.08
4-Bay	313-4A	48.19		



**CHANNEL MASTER CORP.** ELLENVILLE, N. Y.

the world's largest manufacturer of television antennas and accessories



# CHANNEL MASTER'S

new

## TV TRANSMISSION LINE

The first TV wire to give you the benefits of

**20** strands per conductor (20/33 pure copper).

with  
**EVERYTHING**  
but the roof!

installation. From now on, guarantee customer satisfaction with a **COMPLETE CHANNEL MASTER INSTALLATION — FROM TOP TO BOTTOM.**

It's a wood screw insulator



It's a machine screw insulator



All popular types and sizes available, including full assortment of specialized hardware. See your Channel Master distributor

it's got  
**FLEX-APPEAL!**

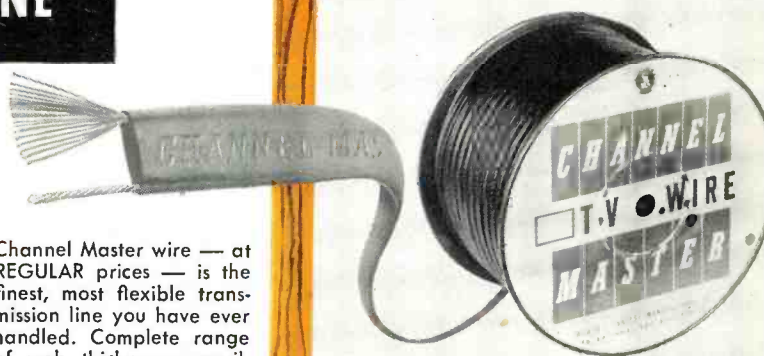

Channel Master wire — at **REGULAR** prices — is the finest, most flexible transmission line you have ever handled. Complete range of web thicknesses available. Colorful display packaging.

### Two outstanding lines:

(both featuring exclusive 20-strand conductor):

#### "TWIN TWENTY"

- Marked every 10 feet. Saves time, ends waste.
- Full width. Available in silver or brown.
- Pure **VIRGIN** polyethylene.

#### "CHALLENGER"

Fine quality transmission line at today's **VERY LOWEST PRICES.**

new

## STANDOUT insulators

Featuring this revolutionary new **2 in 1** screw thread design!

Eliminates the need for stocking separate machine and wood screws. Cuts your inventory investment in standoffs by more than 65%.

- Needle sharp point, made possible by finer thread. Easier to work in wood. Prevents slipping on mast.
- **STANDOUT** buckle has **8** machined threads.
- Convenient "Taper-Tip" strapping, available in galvanized or stainless steel.

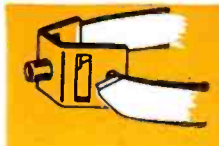

Copyright 1955, Channel Master Corp.





**HERE'S  
ELECTRONIC  
'KNOW-HOW'  
-the quick,  
easy way!**

at the most economical prices!

**2 Important, Authoritative,  
Up-to-date Books on Television**

**TELEVISION — HOW IT WORKS  
(2nd Edition)**

by J. Richard Johnson

Completely rewritten and revised. Here is a practical treatment of TV techniques written for the service man, student, experimenter, hobbyist. This book explains the how and why of modern television receivers in the simplest and most direct terms, and yet in a complete and professional manner.

The mathematical approach is avoided whenever practical physical explanations can be substituted. However, when an equation or mathematical derivation helps to clarify basic principles or their practical applications, it is included, explained and illustrated by text examples and review problems. The text is presented in the time-tested order corresponding to the progress of the received signal from the antenna to the picture tube and loudspeaker. Review questions follow each chapter. Profusely illustrated with specially conceived artwork that makes understanding the text clear and easy.

Only \$4.60

**COLOR TELEVISION  
RECEIVER PRACTICES**

by Hazeltine Corp. Laboratory Staff

World famous for their contribution in the field of electronics, the Hazeltine Corporation Laboratories Staff has prepared a thorough exposition of color television receivers, based on years of research and design.

Every chapter in this book deals with a separate portion of the receiver, and is written by a different Hazeltine Laboratories expert, a specialist in the operation of that particular section. Every major aspect of color receivers is analyzed and thoroughly explained, including the latest 21" picture tube and its circuitry. For the convenience of the reader each chapter contains a summary of the salient points in that chapter.

This significant book, destined to become a standard reference work on the subject, will be of tremendous value to educational institutions, technicians, engineers . . . to everyone who now wants a solid grounding in color.

Only \$4.50

**YOU CAN SEE  
AND BUY RIDER  
BOOKS AT YOUR  
FAVORITE PARTS  
JOBBER OR  
BOOK STORE —  
LOOK FOR THIS  
RIDER DISPLAY!**



**JOHN F. RIDER**  
PUBLISHER, INC. 480 Canal St., N. Y. 13 N. Y.

# Spot Radio News

\* Presenting latest information on the Radio Industry.

By RADIO & TELEVISION NEWS'  
WASHINGTON EDITOR

**THE FORECAST THAT** within five years after the TV freeze lift, at least 2000 telecasters would be on the air was shattered some weeks ago by a CBS consultant who told the Commission that a ceiling of 600 stations, plus perhaps some satellites, looked more realistic to him now. That number of operators could, he felt, adequately serve the nation.

Specifically, it was reported that 600 stations would take care of . . . "about 95% to 97% of the families of the country . . . without satellites . . . and the use of satellites . . . can push this figure fairly close to 100%." The expert noted that more than two-thirds of the 1800-odd channels set aside by the FCC would remain unused, or would be occupied only a short time by stations faced with bleak futures.

Ignoring the ultra-highs, the analyst pointed out that such operation was discounted since the bulk of the stations who would operate on the higher bands as program-originating points would find the going too rough to continue.

The maximum number of 600 was arrived at, the report said, by estimating the coverage of v.h.f. stations; this was set at from 50 to 75 miles. And, the study added: "Larger or smaller radii of coverage would lead to fewer economically supportable stations. Larger radii permit fewer stations to cover a given area, and shorter radii reduce the number of market centers

than can support a station. That is, many market centers which can support a station with a 50-mile radius of coverage can no longer support one with a 25-mile radius of coverage."

However, one bright bit of hope was offered to the members of the Commission. Said the broadcast specialist: "In the long-run future . . . the economics of the industry may, and indeed probably will, change, so that a larger number of stations can eventually be supported. The minimum cost of running a station may decline and increased advertising revenues, particularly from local sources, will undoubtedly be forthcoming. Such was the history of radio broadcasting, and a similar development may be expected in television."

**THE STRONG PREFERENCE** for v.h.f. by a growing number of broadcasters and advertisers, and equally positive views of many in government and industry that u.h.f. has its place in the TV sun, have generated so much confusion in Washington that everyone is clamoring for an immediate public hearing.

Commissioner Rosel H. Hyde, who is anxious to have oral sessions, said that the blizzard of plans which have hit Washington, formally and informally, can only be resolved by an official bull-session. He felt that this was . . . "the only way that we can have all of the pertinent facts placed before us . . . to

## NEW TV GRANTS SINCE FREEZE LIFT

Continuing the listing of construction permits granted by FCC since lifting of freeze. Additional stations will be carried next month.

STATE	CITY	CALL	CHANNEL	FREQUENCY	POWER*
Massachusetts	Boston	WHMB	38	614-620	251
North Dakota	Minot		10	192-198	29.5
Ohio	Youngstown		73	824-830	16.6

### NEW CALL LETTER ASSIGNMENTS

STATE	CITY	CALL	CHANNEL	FREQUENCY
Florida	Orlando	WEAL-TV	18	494-500
Pennsylvania	Philadelphia	WPHD	23	524-530

### CALL LETTER CHANGES

STATE	CITY	CALL	CHANNEL	FREQUENCY
Colorado	Denver	KTVR (Formerly KFEL-TV)	9	186-192
Nevada	Hayes Center	KHPL-TV (Formerly KHOK-TV)	6	82-88

\*ERP=(effective radiated power, kw.)



# EXPO PRESENTS

# I. R. I. S. \*

INFINITE REJECTION INTERFERENCE SYSTEM

the world's first fundamental and complete answer to the interference problem...

### \* The Sensational I.R.I.S.

gives infinite rejection of the interfering signal regardless of direction or channel or whether the interference is co-channel, adjacent channel or ghosts.

The rejection of the interfering signal is accomplished by opposing the interfering signal with a signal of equal amplitude but of opposite phase, thus producing complete cancellation. Simply rotate the upper section of the antenna to a position where the interference disappears.

Can be used either in a fixed installation or with rotor. All accessories and harness furnished for quick, easy installation.

### The Famous EXPO Antenna

is used in I.R.I.S. with its fundamental unlimited bandwidth characteristic, thus insuring excellent performance throughout the 82 channels.

No more Venetian blinds, or ghosts or distortion from an interfering co-channel signal or "splatter" from a strong local station.

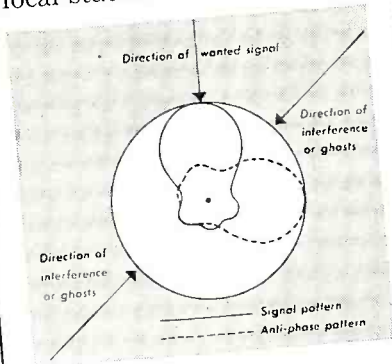

The combination of the principle of the exponential curve and the proved performance of I.R.I.S. offers an exceptional sales potential, both in antennas and TV sets. Now is the time to cash in on this exclusive opportunity.

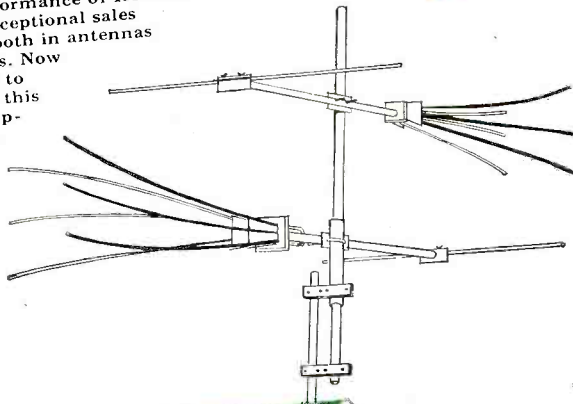

\*Pat. applied for

EXPO-I.R.I.S. comes in the following models:

- XO2R6 2-bay, 6 element EXPO-I.R.I.S. List \$20.95
- XO2R8 2-bay, 8 element EXPO-I.R.I.S. List \$25.50
- XO4CR6 4-bay, 6 element colinear EXPO-I.R.I.S. List \$53.25
- XO4CR8 4-bay, 8 element colinear EXPO-I.R.I.S. List \$61.75

**ORDER TODAY FROM YOUR DISTRIBUTOR**

whom we will supply until official distributors are designated in your locality.



**HOLLOWAY ELECTRONICS CORP.**  
Fort Lauderdale, Florida

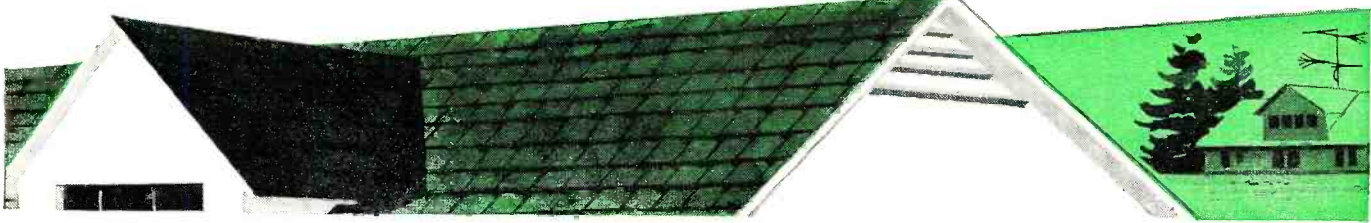



# First Announcement!

## New Sonotone "3" Series SUPER-FIDELITY Ceramic Cartridges

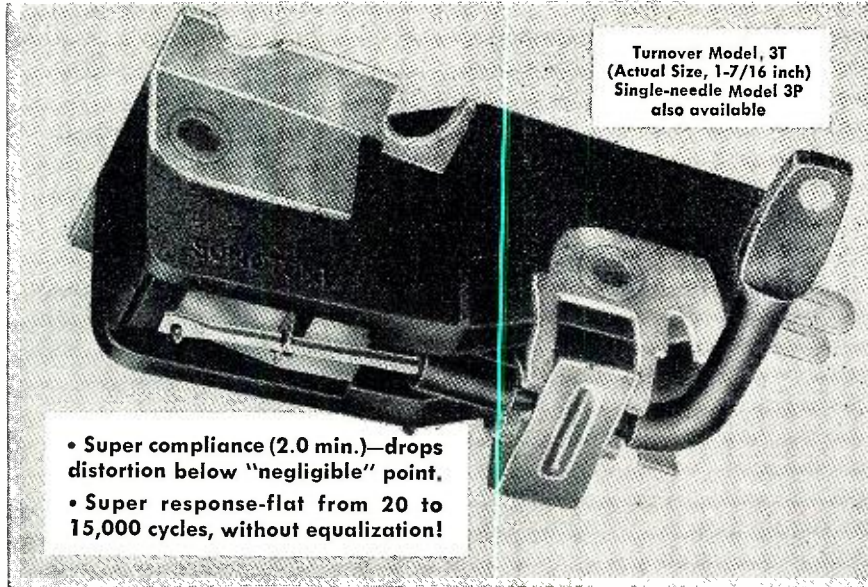

Turnover Model, 3T  
(Actual Size, 1-7/16 inch)  
Single-needle Model 3P  
also available

- Super compliance (2.0 min.)—drops distortion below "negligible" point.
- Super response—flat from 20 to 15,000 cycles, without equalization!

### PARDON US IF WE CALL THEM "REVOLUTIONARY"...

but these new cartridges obsolete pre-amplifiers, equalizers, and old-style pickups!

If you've followed the development of ceramic cartridges since Sonotone pioneered them in 1946, you know we've made enormous advances.

Recently Sonotone has offered ceramic cartridges equal, by test, to most velocity types. Now, Sonotone presents the "3" Series, which set utterly *new* standards of finest performance, by all the measurements engineers know how to make.

These new cartridges make the *inherent* advantages of the ceramic type loom larger than ever. Consider:

#### WHY A PRE-AMP?

There is only one reason for a pre-amplifier—a velocity pickup puts out too feeble a voltage to drive your amplifier directly. But these Sonotone "3" Series cartridges deliver a whopping 0.5 volts—roughly 50 times as much as most velocity types. So you can *eliminate* the circuitry, noise, space and expense a pre-amp involves. (If you now have a pre-amp, our simple adaptor permits immediate use of Sonotone "3" Series cartridges in your present system.)

#### EQUALIZING UNNECESSARY

Sonotone "3" Series cartridges end equalization nuisance because ceramic cartridges respond to *amount* of needle movement not velocity. Result, they self-equalize.

These new cartridges eliminate mag-

netic hum problems. Fit any of the widely used arms.

Single needle model, with diamond, only \$30.00 LIST. Turnover model with sapphire-diamond needles, \$32.50 LIST. Less with sapphires.

#### NEW SONOTONE AMPLIFIER

We built this HFA-100 to realize the full excellence of Super-Fidelity ceramics.

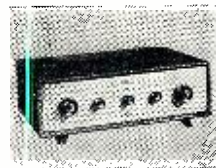

Hum, noise and distortion are virtually unmeasurable—at maximum settings, distortion is only 0.15%! Cabinetry is superb solid mahogany, with solid brushed brass panel. \$117.50 NET. Similar control unit, for use with power amplifier, \$59.00 NET.

"Revolutionary" is a big word. But these Sonotone developments are pretty big news, if you like music!

**SONOTONE®**  
CORPORATION, ELMSFORD, N. Y.



permit us to reach well-considered decision. . . ." At such a hearing, he continued, all of the facts could be . . . "fully and accurately tested and developed."

Answering those who felt that the proposed hearings would lead to a new "freeze", the Commissioner said that the procedures . . . "should not . . . be permitted to take more than a few months."

Commenting on his personal views on the future of the high bands, Hyde said that even though u.h.f. is . . . "sick, it still remains as one of the basic foundations for the proper development of the industry." He based his opinion on the engineering views of those with . . . "tremendous experience." These experts, he said, have repeatedly declared that . . . "There is nothing fundamentally wrong with u.h.f. as a technical service."

**U.H.F. BROADCASTERS** have stormed the FCC with requests that hearings be held as quickly as possible and they warned the Commission that no action must be taken that . . . "would render the problem moot, and make consideration of any effective nationwide solutions of the u.h.f. problem impractical or impossible to attain."

Reviewing some of the v.h.f. expansion plans suggested, some of the high-band proponents said that even the FCC staff members agreed that the drop-in or squeeze-in v.h.f. ideas would all have a serious effect on the future of high-band operation. First, it was noted, such a program would eventually destroy the public's present multi-million dollar investment in antennas and converters. Any change in station separations would certainly rob stations of their existing service areas. In addition, it was felt that new interference problems would occur. According to some engineers of the Commission, the proposed directional antennas would cause trouble in the form of reflections from nearby structures.

Support for the ultra-highs also came from a committee of RETMA, who advised the Commission that the television service, in their opinion . . . "needs both the u.h.f. and v.h.f. channels now assigned . . ." for complete coverage of the nation.

**THE DEVELOPMENT OF A MOBILE,** air-traffic control system that can be used at air fields in remote areas of the world, known as *project two wheels*, has been revealed by the Air Research and Development Command, Rome (N. Y.) Air Development Center at Griffiss Air Force Base.

Featured in the new setup are seven small trailer-mounted shelters which are lightweight and compact enough to permit transportation in a C-47 type aircraft, or which may be towed by jeep or truck for distances of several hundred miles.

The two-wheel trailers house an assortment of gear built for ruggedness, durability, and precision. The  
(Continued on page 126)



# I Will Train You at Home

## for Good Pay Jobs, Success in

# RADIO-TELEVISION

J. E. SMITH  
President  
National Radio  
Institute  
Washington, D. C.  
40 years of success  
training men at  
home in spare time.



I'll Prove It Is Easy And  
Practical To Learn At Home.  
Sample Lesson FREE.



To See Equipment I Send You  
For Practical Experience...  
Get Illustrated Book FREE.

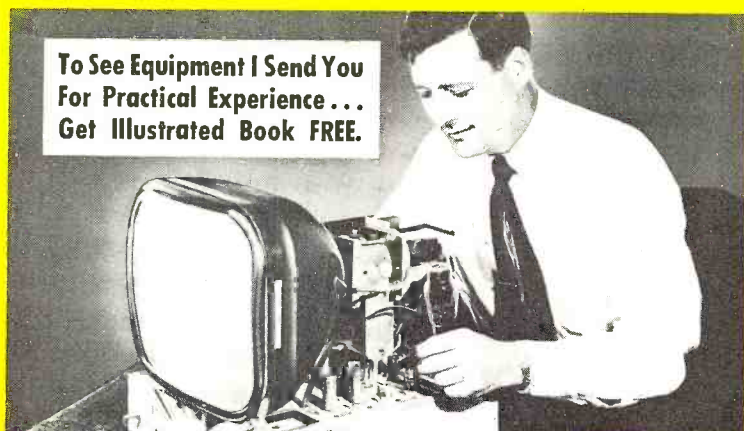

### Practice Broadcasting with Equipment I Send

It's practical to train at home for good Radio-TV jobs and a brighter future. As part of my Communications Course I send you kits of parts to build the low-power Broadcasting Transmitter shown at the left. You use it to get practical experience performing procedures demanded of Broadcasting Station Operators. An FCC Commercial Operator's License can be your ticket to a better job and a bright future; my Communications Course gives you the training you need to get your license. Mail card below and see in my book other valuable equipment you build. Get FREE sample lesson.

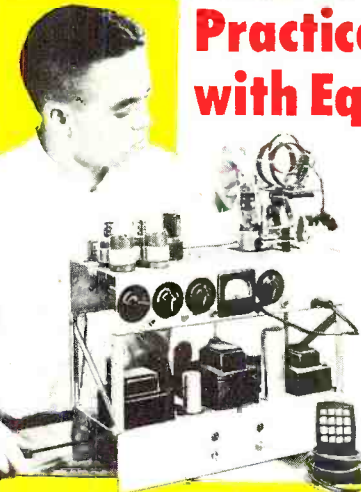

### Practice Servicing with Equipment I Send

Self-confidence, security, earning power come from knowing-how and from experience. Nothing takes the place of PRACTICAL EXPERIENCE. That's why NRI training is based on LEARNING BY DOING. You use parts I furnish to build many circuits common to Radio and Television. With my Servicing Course you build a modern Radio (shown at right). You build a Multitester, use it in conducting experiments, fixing sets in spare time starting a few months after enrolling. All equipment is yours to keep. Card below will bring book showing other equipment you build. Judge for yourself whether you can learn at home in your spare time.



### Television Is Growing Fast Making New Jobs, Prosperity

More than 30 million homes now have Television sets and thousands more are being sold every week. Well trained men are needed to make, install, service TV sets and to operate hundreds of Television stations. Think of the good job opportunities here for qualified technicians, operators, etc. If you're looking for opportunity, get started now learning Radio-Television at home in spare time. Cut out and mail postage-free card. J. E. Smith, President, National Radio Institute, Washington, D. C. Over 40 years' experience training men at home.

AVAILABLE TO  
**VETERANS**  
UNDER G.I. BILL

Good Jobs  
Good Pay **See Other Side**

Get My **SAMPLE LESSON** and  
64-Page Illustrated Book  
**BOTH FREE**

Cut out and mail  
card NOW!

This card entitles you to Actual Lesson on Servicing, shows how you learn Radio-Television at home. You'll also receive my 64-page Book, "How to Be a Success in Radio-Television." Mail card now!

**NO STAMP NEEDED! WE PAY POSTAGE**

Mr. J. E. SMITH, President  
National Radio Institute, Washington 9, D. C.

Mail me Lesson and Book, "How to Be a Success in Radio-Television." (No Salesman will call. Please write plainly.)

NAME.....AGE.....

ADDRESS.....

CITY.....ZONE.....STATE.....

**VETS** write in date of discharge.....

K L M O P

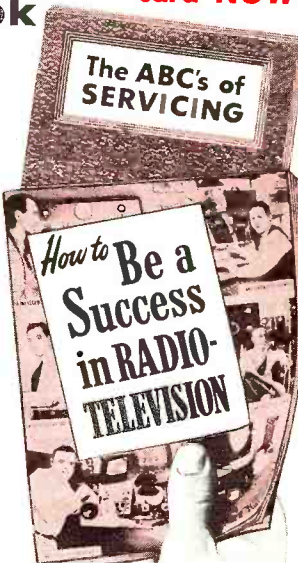



# Train at Home to Jump Your Pay as a RADIO-TV Technician



J. E. Smith, President

## National Radio Institute

The men whose messages are published below were not born successful. Not so long ago they were doing exactly as you are now... reading my ad! They decided they should **KNOW MORE**... so they could **EARN MORE**... so they acted! Mail card below now.

## Get a Better Job—Be Ready for a Brighter Future in America's Fast Growing Industry

Training PLUS opportunity is the PERFECT COMBINATION for job security, good pay, advancement. When times are good, the trained man makes the BETTER PAY, GETS PROMOTED. When jobs are scarce, the trained man enjoys GREATER SECURITY. NRI training can help assure more of the better things of life.

Radio-Television is today's opportunity field. Even without Television, Radio is bigger than ever before. Over 3,000 Radio Broadcasting Stations on the air; more than 115 million home and Automobile Radios are in use. Television Broadcast Stations extend from coast to coast now with over 30 million Television sets already in use. Over 400 Television stations are on the air and there are channels for hundreds more.

Use of Aviation and Police Radio, Micro-Wave Relay, Two-way Radio communication for buses, taxis, trucks, etc., is expanding. New uses for Radio-Television principles coming in Industry, Government, Communications and Homes.

## My Training Is Up-to-Date You Learn by Doing

Get the benefit of our 40 years' experience training men. My well-illustrated lessons give you the basic principles you must have to assure continued success. Skillfully developed kits of parts I furnish "bring to life" the principles you learn from my lessons. Read more about equipment you get on other side of this page.

More and more Television information is being added to my courses. The equipment I furnish students gives experience on circuits common to BOTH Radio and Television.

## Find Out About this Tested Way to Better Pay

Read at the right how fellows who acted to get the better things of life are making out now. Read how NRI students earn \$10, \$15 a week extra fixing Radios in spare time starting soon after enrolling. Read how my graduates start their own businesses. Then take the next step—mail card below.

You take absolutely no risk. I even pay postage. I want to put an Actual Lesson in your hands to prove NRI home training is practical, thorough. I want you to see my 64-page book, "How to Be a Success in Radio-Television," because it tells you about my 40 years of training men and important facts about present and future Radio-Television job opportunities. You can take NRI training for as little as \$5 a month. Many graduates make more than the total cost of my training in two weeks. Mailing postage-free card can be an important step in becoming successful. J. E. Smith, President, National Radio Institute, Washington 9, D. C. Training Men for Over 40 years. Approved Member, National Home Study Council.

## I TRAINED THESE MEN



### Lots of Spare-Time Jobs

"I do a lot of spare-time Radio and TV servicing. It was fun learning and I don't know how to thank you." B. Goede, Plainview, Minn.



### Now TV Trouble Shooter

"I had only gone to 7th grade when I started course. Now have job as TV troubleshooter, also fix sets spare time." M. B. Lindemuth, Fort Wayne, Ind.



### Engineer with WHPE

"Thanks to NRI I operated a successful Radio repair store. Then I got a job with WPAQ and now am an engineer for WHPE." V. W. Workman, High Point, N. C.



### NRI Course Can't Be Beat

"Am with WCOC. NRI Course can't be beat. No trouble passing 1st class Radio-phonc license examination." Jesse W. Parker, Meridian, Mississippi.



### Quit Job for Own Business

"I decided to quit my job and do TV work full time. I love my work and am doing all right financially." William F. Kline, Cincinnati, Ohio.



### Extra Money in Spare Time

"I am a police captain and also have good spare-time service business. Just opened my new showrooms and shop." C. W. Lewis, Pensacola, Fla.

## Start Soon to Make \$10 to \$15 a Week Extra Fixing Sets



Keep your job while training. Many NRI students make \$10, \$15 and more a week extra fixing neighbors' Radios in spare time, starting a few months after enrolling. The day you enroll I start sending you special booklets that show you how to fix sets. The multimeter you build with parts I furnish helps discover and correct troubles.

## SEE OTHER SIDE

FIRST CLASS  
Permit No. 20-R  
(Sec. 34.9, P.L. & R.)  
Washington, D. C.

## BUSINESS REPLY CARD

No Postage Stamp Necessary If Mailed In The United States

POSTAGE WILL BE PAID BY

NATIONAL RADIO INSTITUTE

16th and U Sts., N.W.

Washington 9, D. C.

## My Training Leads to Jobs Like These

**BROADCASTING:** Chief Technician, Chief Operator, Power Monitor, Recording Operator, Remote Control Operator. **SERVICING:** Home and Auto Radios, P.A. Systems, Television Receivers, Electronic Controls, FM Radios. **IN RADIO PLANTS:** Design Assistant, Transmitter Design Technician, Service Manager, Tester, Serviceman, Research Assistant. **SHIP AND HARBOR RADIO:** Chief Operator, Assistant Operator, Radiotelephone Operator. **GOVERNMENT RADIO:** Operator in Army, Navy, Marine Corps, Coast Guard, Forestry Service Dispatcher, Airways Radio Operator. **AVIATION RADIO:** Plane Radio Operator, Transmitter Technician, Receiver Technician, Airport Transmitter Operator. **TELEVISION:** Pick-Up Operator, Voice Transmitter Operator, Television Technician, Remote Control Operator, Service and Maintenance Technician. **POLICE RADIO:** Transmitter Operator, Receiver Serviceman.

# SAMPLE LESSON and 64-Page BOOK BOTH FREE CUT OUT AND MAIL POSTAGE-FREE CARD

## Have Your Own Business

Many NRI trained men start their own successful Radio-Television sales and service business with capital earned in spare time. Joe Travers, a graduate of mine, in Asbury Park, N. J., writes: "I've come a long way in Radio and Television since graduating. Have my own business on Main Street."







# Silver Vision

**THE ALUMINIZED TUBE THAT IS PRE-SOLD**

Sure, *you* are already sold on the advantages of aluminized tubes. You know that the CBS Silver Vision aluminized screen with its silver-activated phosphors and the CBS small-spot gun mean clearer, sharper, brighter pictures.

But your woman customer (76.9% of TV service customers are women) doesn't understand electronics or CBS advanced-engineering as you do.

She does know and respect the name CBS . . . she has confidence in Garry Moore and in the Good Housekeeping Guaranty Seal.

So all you have to do is take advantage of Garry's pre-selling over the CBS Television Network. Just remind her that there are no finer tubes made than

CBS Silver Vision tubes . . .

And, like all CBS tubes,

they

have the

Good

Housekeeping

Guaranty Seal.

She's already pre-sold

by Garry Moore and

national magazine

advertising. You build

profitable customer

confidence and sales

every time you

recommend CBS

Silver Vision tubes.



Show the CBS carton with the Good Housekeeping Guaranty Seal January, 1956



Garry Moore  
famous CBS  
Television Star

**CBS-HYTRON**

Danvers, Massachusetts

A DIVISION OF

COLUMBIA BROADCASTING SYSTEM, INC.



PACKED WITH BARGAINS

# FREE!

## LAFAYETTE

132 PAGE ELECTRONIC CATALOG

SAVE ON EVERYTHING IN ELECTRONICS

Big Money Saving Values!

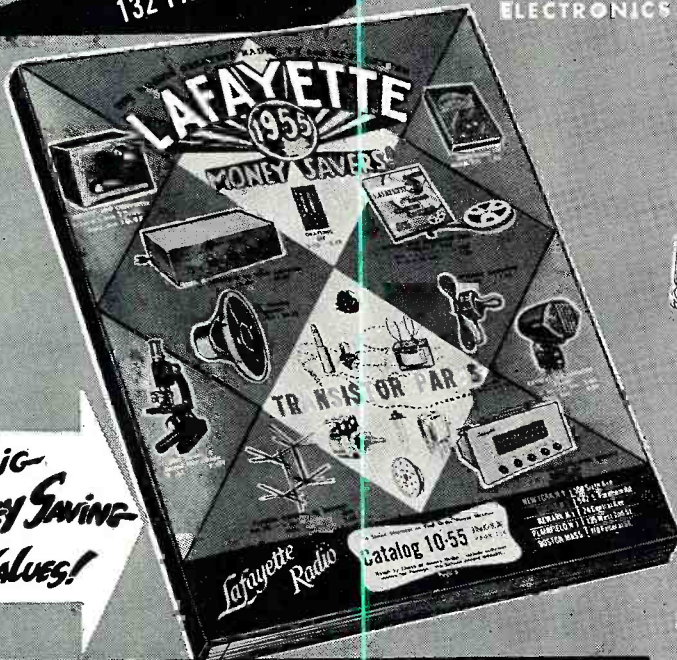

### NEW LAFAYETTE CATALOG GET YOURS NOW IT'S FREE

Packed with the largest selection of Electronic, Radio and T.V. Parts, and equipment, PA, Hi-Fi systems, tubes, antennas, Transistor Kits, parts and components, Test Equipment, new build your own kits, tools, books, Microscope, drafting equipment, Binoculars, Telescopes, All Radio, TV and Ham supplies — ALL AT GREAT SAVINGS — For the economy minded servicemen, dealer, engineer and technician. **CHUCK FULL OF BUYS! SEND FOR YOUR FREE COPY TO-DAY.**

**Lafayette Radio** 100 SIXTH AVE. NEW YORK, N.Y. DEPT. RA  
Include postage with order

**LAFAYETTE RADIO**  
100 SIXTH AVE., NEW YORK, N.Y.  
Send FREE 132-Page 1955 Lafayette Catalog

Name \_\_\_\_\_  
Address \_\_\_\_\_  
City \_\_\_\_\_ Zone \_\_\_\_\_ State \_\_\_\_\_

BOSTON, MASS.  
110 Federal St.

BRONX, N.Y.  
542 E. Fordham Rd

NEWARK, N.J.  
24 Central Ave.

PLAINFIELD, N.J.  
139 West 2nd St

#### HIGH-FIDELITY TURNOVER CARTRIDGE



2.75  
Reg. Price  
~~8.50~~

● 40-14000 CYCLE  
● NEVER BEFORE AT SUCH A PRICE!  
Lafayette brings you one of the finest high-fidelity turnover cartridges, AT AN UNBELIEVABLE PRICE! Frequency response from 40-14000 cycles  $\pm 2$  db. Has 2 sapphire styli to play all speeds. Needle pressure only 5 grams on LP cond 12-15 grams on 78. Output is 5 volts. Complete with turnover mechanism and knob, fits Webster, Garrard, VM, Collaro and tone arms of leading manufacturers of record changers and players.  
PK-79 ..... Singly, Each 2.75  
In lots of 3, Each 2.50

#### CRYSTAL MICROPHONE

COMPARE IT WITH ANY MIKE AT 2 TO 3 TIMES THE PRICE

A quality crystal Microphone for PA systems, house phones, etc. Frequency response 30 to 10,000 cycles. Output level  $-52$  db. Provides ample output for use with low gain amplifiers. Complete with  $3\frac{1}{2}$  ft. of shielded cable. Shpg. wt., 1 lb.



PA-24— in lots of 3, each ... 3.95 singly, each ..... 4.25

#### SLIM HIGH OUTPUT DYNAMIC MICROPHONE

Reg. Price ~~41.50~~ Net 9.95

A pencil-slim design, high output PA Dynamic Microphone of exceptional quality, at a price that is  $\frac{1}{2}$  of the price of any comparable microphone on the market today. Very smooth response 50-110,000 cycles. Omnidirectional, tiltable head. Switch on side gives choice of either high impedance (50,000 ohms) or low impedance (250 ohms). Instantly removable bracket permit use either on stand or as hand mike. Features exceptional mechanical strength. Cast case with satin chrome finish,  $\frac{5}{8}$ "-27 thread, Acoustically-treated grille head, 8" long;  $1\frac{1}{4}$ " barrel diameter. Shipping weight 2 lbs.  
PA-29 ..... In lots of 3, Each 9.95  
Singly, Each 12.95



NEW!

#### TELEPHONE PICKUP

FOR RECORDING TELEPHONE CONVERSATIONS

Induction telephone pickup. Telephone conversations can now be picked up with no tapping of wires or special telephone circuits. Simply place the phone base in the cradle or upright type, on the pickup platform and connect the leads to the high impedance input of any medium gain audio amplifier, or directly to any tape disc or wire recorder.  
MS-16 ..... 2.95



TRANSISTOR 455 KC I.F.

Specially designed for transistor circuits, only  $\frac{1}{2}$ " square by  $\frac{3}{4}$ " high.  
MS-126 ..... In lots of 10, each 79¢  
Single, Each ..... 89¢

#### A NEW LIGHT WEIGHT DYNAMIC EARPHONE



Fits right into the ear. Ideal for use with radio sets, for private listening. DC resistance 2000 ohm impedance 5000 ohm with 3 ft of Plastic Cord.  
Net 1.95  
MS-72 ..... Impedance 8 ohm for silent radio or TV viewing.  
Net 1.95

MS-260 — FOR TRANSISTOR CIRCUITS. Special high out put for low power circuits; DC resistance 2000 ohm, impedance 8000 ohm.  
Net 3.95

#### RAYTHEON TRANSISTOR

CK722 P-N-P \$0.99



#### TRANSISTOR LOOP ANTENNA



Fixed inductance tapped to match 600 ohm input. Covers 540-1650 kc with 365 mmf variable cond. size  $9\frac{1}{16}$ " x  $4\frac{1}{16}$ ".  
MS-166 Net 1.25

#### TRANSISTOR TYPE 2N107

P-N-P \$1.25



TRANSISTOR OSCILLATOR COIL

Supplies local OSC. energy to mixer stage, 1F 455 KC. Use with 365 mmf cond.  $\frac{5}{8}$ " x  $1\frac{1}{8}$ " high.  
MS-165 ..... Net 49¢

New Price!

4.65

RAYTHEON TRANSISTOR CK-760 (2N112)

#### HIGH SENSITIVITY AC-DC MULTITESTER

20,000 OHMS PER VOLT DC and 10,000 OHMS PER VOLT AC

The New Lafayette High Sensitivity Multitester is a complete instrument (not a kit) packed with every desirable feature found in instruments costing twice as much. One of the most sensitive multitesters ever offered: 20,000 ohms per volt DC and 10,000 ohms per volt AC; having a highly sensitive 35 microamp meter. Check these full scale readings. DC Volts: 0-6; 0-12; 0-60; 0-300; 0-1200; 0-6000 volts at 20,000 ohms per volt. AC Volts: 0-12; 0-60; 0-300; 0-1200 at 10,000 ohms per volt. DC current ranges: 60 microamp, 0-6; 0-60; 0-600 milliamps. Resistance ranges: 0-4; 0-40; 0-400K; 4 meg. ohms. Decibel:  $-20$  to  $+17$  db (0 = .774 volt). Capacity: 250 mmf-10 MF. Inductance: 20-1000 millihenry. Extreme versatility and accuracy; 1% precision resistors.  $\frac{3}{4}$ " meter; plastic front with metal bottom for ruggedness. Size:  $5\frac{3}{4}$ " x  $3\frac{3}{4}$ " x  $2\frac{3}{4}$ "; complete with batteries and test leads. Shipping weight 4 lbs.  
RW-30A ..... In lots of 3, Each 19.25  
Singly, Each 19.95



#### IMPORTED BINOCULARS

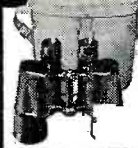

All have coated lenses — clamped in prisms — light weight all metal bodies. Complete with case and straps.  
FULLY GUARANTEED FOR 90 DAYS AGAINST MECHANICAL AND OPTICAL DEFECTS.  
ADD 10% PER. TAX TO PRICES

F-182	8x.15	I.F.	NET 10.75
F-105	8x.30	I.F.	NET 17.95
F-15	7x.35	I.F.	NET 17.95
F-183	7x.35	C.F.	NET 20.95
F-182	7x.50	I.F.	NET 21.50
F-184	7x.50	C.F.	NET 24.95
F-117	10x.35	C.F.	NET 23.95
F-104	12x.50	C.F.	NET 27.95
F-118	18x.50	C.F.	NET 31.50
F-185	20x.50	C.F.	NET 37.50



C. C. Lane, B.S., M.A.  
 President, Radio-Television  
 Training Association  
 Executive Director, Pierce  
 School of Radio & Television.



VETERANS - - NON-VETERANS  
**Do You Want a BETTER  
 JOB with MORE MONEY?**

**I will train you AT HOME in your SPARE TIME  
 for a top-pay lifetime job in TELEVISION**

The world's leading manufacturers, dealers and service organizations employ men I trained. Even if you've never had any experience in the Television-Radio-Electronics field, you'll recognize most of the names of just a few of the firms where RTTEA-trained men are holding down good jobs with a secure future —

RCA • SYLVANIA • WESTINGHOUSE  
 BOEING • GENERAL ELECTRIC • LEWY  
 EMERSON • DOUGLAS AIRCRAFT  
 CAPEHART-FARNSWORTH • PHILCO  
 CANADAIR, LTD. • WESTERN ELECTRIC  
 OAK RIDGE NATIONAL LABORATORY  
 AMERICAN AIRLINES • COLUMBIA  
 BELL TELEPHONE • ADMIRAL • DUMONT  
 REDIFFUSION, INC. • BELL AIRCRAFT  
 RAYTHEON • CONVAIR

**LEARN BY DOING**

As part of your training I give you the equipment you need to set up your own home laboratory and prepare for a BETTER-PAY TV JOB. You build and keep an Electromagnetic TV RECEIVER designed and engineered to take any size picture tube up to 21-inch. (10-inch tube furnished. Slight extra cost for larger sizes.) . . . also a Super-Het Radio Receiver, AF-RF Signal Generator, Combination Voltmeter-Ammeter-Ohmmeter, C-W Telephone Transmitter, Public Address System, AC-DC Power supply. Everything supplied, including all tubes.



**STUDY NEWEST DEVELOPMENTS**

My training covers all the latest developments in the fast-growing Television-Radio-Electronics industry. You learn about FM — RADAR — COLOR TV — TRANSISTORS — PRINTED CIRCUITS, etc.

**CHOOSE FROM THREE COMPLETE COURSES**

covering all phases of Radio, FM and TV

1. Radio, FM and Television Technician Course — no previous experience needed.
2. FM-TV Technician Course — previous training or experience in radio required.
3. TV Cameraman and Studio Technician Course — advanced training for men with Radio or TV training or experience.

**EXTRA TRAINING IN NEW YORK CITY AT NO EXTRA COST!**

After you finish your home study training in Course 1 or 2 you can have two weeks, 50 hours, of intensive Lab work on modern electronic equipment at our associate resident school, Pierce School of Radio & Television. **THIS EXTRA TRAINING IS YOURS AT NO EXTRA COST WHATSOEVER!**

**FCC COACHING COURSE**  
 Important for BETTER-PAY JOBS requiring FCC License! You get this training **AT NO EXTRA COST!** Top TV jobs go to FCC-licensed technicians.

**EARN WHILE YOU LEARN**  
 Almost from the very start of your course you can earn extra money by repairing sets for friends and neighbors. Many of my students earn up to \$25 a week . . . pay for their entire training with spare time earnings . . . start their own profitable service business.

I can do for you what I did for my hundreds of successful graduates. Many of the men I trained are now their own bosses—making a wonderful living in their own growing business.

You, too, can win a place in the booming Television-Radio-Electronics industry . . . earn big money as a trained TV Technician . . . with my famous "Learn by Doing" home study method.

**FREE!**

I'll send you my new 40-page book, "How to Make Money in Television-Radio-Electronics," a Free sample lesson, and other literature showing how and where you can get a top-pay job in Television.



**VETERANS!**

My School fully approved to train Veterans under new Korean G. I Bill. Don't lose your school benefits by waiting too long. Write discharge date on coupon

**MAIL THIS COUPON TODAY!**

Mr. Leonard C. Lane, President  
 RADIO-TELEVISION TRAINING ASSOCIATION  
 Dept. T-1C, 52 East 19th Street, New York 3, N. Y.

Dear Mr. Lane: Send me your NEW FREE BOOK, FREE SAMPLE LESSON, and FREE aids that will show me how I can make TOP MONEY IN TELEVISION. I understand I am under no obligation.

(PLEASE PRINT PLAINLY)

Name \_\_\_\_\_ Age \_\_\_\_\_

Address \_\_\_\_\_

City \_\_\_\_\_ Zone \_\_\_\_\_ State \_\_\_\_\_

- I AM INTERESTED IN:
- Radio-FM-TV Technician Course
  - FM-TV Technician Course
  - TV Cameraman & Studio Technician Course

**VETERANS!**  
 Write discharge date

**Radio Television Training Association**

52 EAST 19th STREET • NEW YORK 3, N. Y.

Licensed by the State of New York • Approved for Veteran Training

**NO OBLIGATION!**



only

# C·D·R Rotors







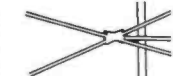

## 1. The Most Complete Line

The CDR Rotor line is COMPLETE to every detail, with a model for every application! A distinct selling advantage because YOU can give your customer EXACTLY what is required! The RIGHT CDR Rotor for the RIGHT job.

## 2. Pre-SOLD For You on TV

to millions of viewers through an extensive coverage of audiences in every important TV market. Capture this pre-sold market by featuring these nationally advertised CDR ROTORS.

 <p><b>AR-22</b></p>  <p><b>AR-1</b></p>  <p><b>AR-2</b></p>	 <p><b>TR-2</b></p>  <p><b>TR-4</b></p>	 <p><b>TR-12</b></p>  <p><b>TR-11</b></p>				
<p>Completely AUTO-MATIC version of the TR-2 with all the powerful features that made it famous.</p>	<p>Completely AUTO-MATIC rotor, powerful and dependable. Modern design cabinet. 4 wire cable.</p>	<p>Completely AUTO-MATIC rotor with thrust bearing. Handsome cabinet, 4 wire cable.</p>	<p>Heavy duty rotor with plastic cabinet, "compass control," illuminated perfect pattern dial, 8 wire cable.</p>	<p>Heavy-duty rotor, modern cabinet with METER control dial, 4 wire cable.</p>	<p>Combination value complete rotor with thrust bearing. Modern cabinet with meter control dial, uses 4 wire cable.</p>	<p>Ideal budget all-purpose rotor, new modern cabinet featuring meter control dial, 4 wire cable.</p>



**CORNELL-DUBILIER**  
SOUTH PLAINFIELD, N. J.



**THE RADIART CORP.**  
CLEVELAND 13, OHIO



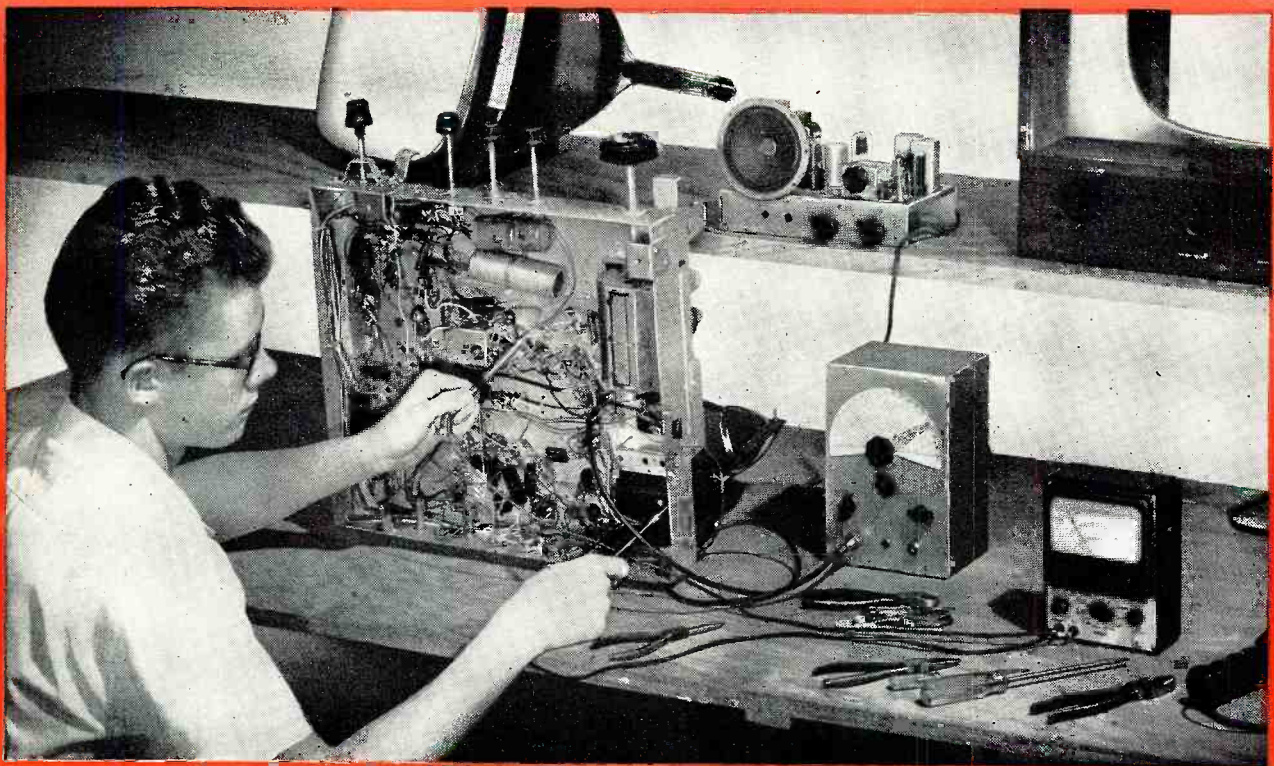

# NOW... RCA trains you at home to be an expert technician in...

**RADIO-TV ELECTRONICS**

**TV SERVICING**

**COLOR TV SERVICING**

**NOW THREE HOME STUDY COURSES** . . . prepared by instructors of RCA Institutes, engineers from RCA Laboratories, and training experts of the RCA Service Company. Clearly written . . . easy to understand . . . the same high caliber instruction as given in the resident classrooms of RCA INSTITUTES.

● **COURSE I—RADIO-TELEVISION ELECTRONICS**—starts you from the ground up to a solid working knowledge of electronics. Without any previous experience, you get a thorough training in radio theory and servicing techniques for AM, FM, home and car radios . . . plus an introduction to the fundamental theory and practices of television.

● **COURSE II—TELEVISION SERVICING**—prepares you to advance from radio into the expanding field of television servicing as a well-trained service technician. If you have completed Course I or are now working in

the field of radio or TV, Course II will show you the many special techniques of troubleshooting, aligning, checking, and repairing modern black and white TV sets.

● **NEW TV KIT AVAILABLE WITH COURSE II**—there is no better way to learn than by *doing* and RCA Institutes has developed a large-screen TV KIT available to home study students to build while taking Course II. It has the most modern up-to-date circuitry, actually enabling you to apply at home all the latest servicing techniques.

● **COURSE III—COLOR TELEVISION SERVICING**—covers all phases of color servicing techniques. It is a practical, down-to-earth course in color theory as well as how-to-do-it servicing procedure. A natural move "up" from Course II or for those now employed in TV.

**SINCE 1909, RCA INSTITUTES** has trained thousands for successful careers in elec-

tronics. Many graduates have established their own paying business. Now this opportunity is available to you at home.

● **"PAY-AS-YOU-LEARN" PLAN** . . . you pay for one study group at a time, as you progress through the course. Tuition costs are amazingly low. For full details, mail coupon.

**A SERVICE OF RADIO CORPORATION OF AMERICA—RCA INSTITUTES** is licensed by the N. Y. State Education Department . . . recommended by radio and television service organizations.

**SEND FOR FREE CATALOG NOW**



RCA Institutes, Inc., Home Study Dept. RN-16  
350 West Fourth Street, New York 14, N. Y.

Without obligation, send me FREE CATALOG on Home Study Courses in Radio, TV and Electronics. No salesman will call.

Name \_\_\_\_\_ Please Print

Address \_\_\_\_\_

City \_\_\_\_\_ Zone \_\_\_\_\_ State \_\_\_\_\_



**RCA INSTITUTES, INC.**

**A SERVICE OF RADIO CORPORATION OF AMERICA  
350 WEST FOURTH STREET, NEW YORK 14, N. Y.**



# OLSON RADIO FOR GREATEST BUYS IN RADIO AND TV SUPPLIES

### TAPE RECORDER BARGAIN

Reg. \$129.50 • Brand New • Limited Supply  
Stock No. AM-8  
List Price \$129.50

## \$79.95



**FREE!** Five 1200' Reels Recording Tape with every Recorder ordered. Dealers—Stock Up Now.

**Two Speed • Two Track • Featuring New "Plug-In" Recording Head**

Here is one of the very few tape recorders with precision die-cast construction. Other features include the exclusive "Tape Guide" for perfect alignment and the pre-equalized heavy duty amplifier. Latest Model Electro-Voice crystal mike included.

Entire outfit is guaranteed to be distortion-free and deliver super-sensitive performance at either speed. Lowest wow and flutter, highest sound-to-noise ratio of any model 3 times its price.

Records and plays back at 3.75 or 7.5 inches per second. Handles both 5" and 7" reels. Records up to 3 hours on one mike, radio, TV or phono. Provisions for external speakers or monitoring headphones. Free response 50 to 7500 cps. Employs a full 5 tube amplifier. Carrying Case is finished in two-tone pin striped forest green. Operates on 115 V. AC 60 cy. Case size 14 3/4 x 11 3/4 x 8 1/2". Weighs 24 lbs. Shpg. wt. 30 lbs.

### HI-QUALITY RECORDING TAPE

### PLASTIC BASE

1200' on 7" Dia. Reel

STOCK NO. X-249  
Single, ea. .... \$2.19  
Lots of 6, ea. .... \$1.79

Lots of 12, Ea. **\$1.59**

This famous brand tape regularly sells for \$5.50—but Olson gives you 71% discount. Perfect in every respect, this quality tape is famous for its low noise level and uniform output. Free, response 50-15,000 cps—red oxide base—wide. Reg. \$1.25 seven inch plastic reel included—fits all recorders. Stock up now during this Giant Sale and get the Tape Buy of Your Life. Shpg. wt. (one doz.) 10 lbs.

### NEW L-O-N-G-E-R PLAY

1800' TAPE ON 7" REEL

STOCK NO. X-583  
Single, ea. .... \$2.99  
Lots of 6, ea. .... \$2.59

Lots of 12, Ea. **\$2.45**

50% more recording time on a 7" reel. Shpg. wt. (one doz.) 12 lbs.

### "GOLDEN GATE" 8" SPEAKER

With "Whizzer" Sound Dispenser

Stock No. S-229  
List Price \$12.50  
Olson's Price, Ea. **\$4.95**

2 for \$9.50

Finely finished in all gold lacquer. Dealers, order these speakers for installation where space is a factor. Will outperform any 12" units. Employs two concentric, rivet mounted cones for extremely smooth response in center of large cone is called a cone in center of large cone is called a "Whizzer" and provides extended wide dispersion angle. Equipped with heavy Alnico 5 magnet and cover. Power handling capacity is 8-10 watts. Impedance 8 ohms. Speaker cone 8" diameter, voice coil 8 ohms. Shpg. wt. 5 lbs.

### GENERAL ELECTRIC S1201A

### HIGH FIDELITY 12" SPEAKER

Stock No. S-184  
List Price \$14.99

DELIVERS 25 WATTS

FAMOUS GE MODEL S-1201A

Highly recommended by famous consumer research organizations. Reg. List \$33.25. Provides clean, smooth frequency response over the range from 50-13,000 cps. Alnico 5 magnet weighs almost a FULL POUND and is guaranteed to deliver bass and treble notes distinctly. Non-varying 1/2" aluminum voice coil. 25 watts. Impedance 8 ohms. Operates perfectly on any Radio, TV or Amplifier. Shpg. wt. 12 lbs.

### Little Champ Remote Speaker

With Volume Control  
Reg. List Price \$9.95

Stock No. S-233  
List Price \$9.95

3 for \$11.00

From your easy chair control volume or shut off either the speaker in TV set or the speaker built into the "Little Champ" console in one minute to any TV set, radio or record player regardless of make or model. Precision engineered Full speaker delivers all necessary volume at your chair or bedside. Completely assembled and supplied with 20 ft. of cable. Ready to operate—complete with hook-up instructions. Shpg. wt. 3 lbs.

### Single Pole—Double Throw Sensitive Plate Circuit Relay

Stock No. SW-64  
List Price \$149 EA.

3 for \$4.00

7500 Ohm DC Coil  
At 1.75 MA. Paladium contacts rated at 3 amps. Impregnated coil, treated for fungus and high humidity. Brand New—excellent for Remote Control, Photo-Electric Relay, Carrier Control Devices and many other uses. An unbeatable price for a relay of this type. Shpg. wt. 1 lb.

### STRIPPER RELAY

Brand New—Original Cost \$11.50  
Stock No. SW-67

**69c** EA.

3 for \$2.00

Here's an unusual buy in a relay that will serve many purposes. Contains 2 relays. When current is applied to No. 1 Relay a lever engages a brass piston which is driven along a precision track. After traveling 1 1/2", the piston automatically signals Relay No. 2 which returns piston to original starting position. Ideal for tripping lens shutters, operating micro switches, or moving any light object 1 1/2" by remote control. Operates on 15 to 24 volts DC. In transparent case. Size 4 x 4 x 3". Shpg. wt. 2 lbs.

### LATCHING-TYPE RELAY

Made by Struthers-Dunn & Allied

Stock No. SW-66  
List Price 69c EA.

3 for \$2.00

Each unit contains 2 relays. Momentary voltage on one coil closes 2 contacts. Same voltage applied to other coil resets first relay. Operates on 12 Volts AC or DC. DPDT contacts will handle 6 amps. Fully guaranteed. Size 3 1/2 x 2 x 1 1/2". Shpg. wt. 2 lbs.

### BASIC PLUG-IN AMPLIFIER

PUSH-PULL Full 10 Watts Output

Stock No. AM-17

**\$7.95** 3 FOR \$22.00

Designed to convert almost any receiver or amplifier with single tube output to push-pull high fidelity 10 watts output. Chassis contains all circuits required, including power supply and heavy duty output transformer. Uses two 6V6, one 6X4, one 6AV6. Chassis size 10" x 5". Converts almost any AC, AC-DC, or 3 way portable to a hi-fi radio, makes even the cheapest AC-DC radio sound like an expensive set. Output matches any 3.2-4 ohm speaker. Easy to install. Simply remove output tube from set and plug into socket from amplifier into that socket. Connect set speaker to amplifier, that's all. AC accessory socket provided on top of chassis. Can also be used as booster PA amplifier, PA amplifier, modulator or converted to complete PA or hi-fi amplifier. Instructions included for tube. Operates on 115 V. AC 60 cy. Less tubes. Shpg. wt. 7 lbs.

SEE OUR WESTINGHOUSE TUBES FOR ABOVE AMPLIFIER. **\$3.24**

### NEW SENCOTUBE CHECKER

Stock No. TE-80  
List Price \$275

TE-80

A must for servicing new series filament TV sets. Automatically checks all filaments including 60 and P C T U R E tubes. Has built-in neon lamp and can be used as continuity and voltage tester too. Simple to use. Just plug tube into tester, if neon light glows, filament is good. In factory packed cartons. Shpg. wt. 2 lbs.

### CABINET REPAIR KIT

Stock No. K-86  
List Price \$295

Kit Only. Reg. List \$5.95

Now you can do a perfect cabinet refinishing job with this kit. No experience necessary. Contains everything you need for repairing dents, nicks or scratches in wood or plastic. You get 4 different shades of shellac sticks, bottle of French rubbing oil, alcohol burner, stainless steel spatula, felt rubbing block, and professional polish. Attractively packaged and supplied with full instructions. Shpg. wt. 4 lbs.

### 9-PIECE DRILL KIT

Stock No. TL-9  
List Price \$69c

Set of 9 tempered carbon drill bits. Sizes 1/16" to 3/16". Plastic holder included. Shpg. wt. 1 lb.

### COMPLETE WIRE ASSORTMENT

Contains all the popular types of wire needed by the radio man. Notice that our price on the whole is less than HALF of the usual wholesale price.

- Reg. Wholesale
- KIT CONTAINS**
- 500 ft. Hook-up Wire, 5-100' Coils, assorted colors. .... \$3.50
  - 100 ft. Hi-Voltage Poly. Insulated cable, 30,000 volt ..... 1.00
  - 100 ft. Shielded wire for phones, etc. 3.50
  - 100 ft. 2 conductor cable for intercoms and speaker extensions ..... 2.00
  - 100 ft. 18 gauge wire for heavy current loads ..... 1.00
- 900 FEET, REG. WHOLESALE \$11.00**

### STOCK NO. W-244 \$4.99

Your Cost Only **\$4.99**

FREE! Wire Stripper With Each Kit.

FOR USE ON ALL SOLID OR STRANDED HOOK-UP WIRE, LINE CORD, ETC. Hardened and ground steel blades, cut with smooth shearing action, stripping or cutting wire neat and clean. Save time and effort on any type of construction or installation work. Adjustable calibrated stop on handle permits proper stripping each time. A tool suitable for production, service or experimental jobs.

### PRINTED CIRCUIT KIT

Stock No. KB-27  
List Price \$375

Each **\$375** KIT



The latest marvel of electronics—now you can easily make your own printed circuits. Includes enough material to make several printed circuits of your own design. In addition, two circuit patterns are included to help you learn the techniques of printed circuit kit construction. 2 copper laminated boards, 4 1/2" x 3", 4 1/2" x 2", 3" x 2 1/2"; one each 7 and 9 pin printed circuit sockets, one pocket etchant; etching tray; tape resist; eyelets for terminals; one No. 52 drill for terminal holes; and complete illustrated instructions explaining theory use and construction. Shpg. wt. 3 lbs.

### PANEL METERS

DC Ammeter—Records Charging Rates  
Choice of 2 Movements

Stock No. TE-81  
List Price \$4.95

10 AMP **4.95** EA.

Stock No. TE-82  
List Price \$2.00

20 AMP **2.00** 6 FOR \$2.00  
MAY BE ASSORTED

Brand New! Now available at less than manufacturing cost. Sturdy meters with shock resistant movements. Sensitive terminals and solder lugs. 2" Diameter. Hand-some enamel finish. Choice of 10 or 20 amp movements. Comes in 2 colors, read OFF—CHARGING—DANGER. Shpg. wt. 1 lb.

### INTERPHONE AMPLIFIER

Signal Corps  
Stock No. AM-15  
List Price \$199

Special \$5.00

Attention: Schools, Clubs, large Dealers—write for quantity price.

Brand new in factory sealed cartons. Original cost \$32.00 contains a wealth of valuable parts including 5 x 2 1/2 x 8" aluminum case, 354 tube, socket, condensers, resistors, jacks, input and output terminals, battery holders, etc. For operation on 2 flashlight cells and one 67 1/2 volt battery.

Ready to operate or can be rewired for many other uses, such as: baby-sitter amplifier, SW or BC receiver, transceiver, crystal set audio amplifier, etc. The polished aluminum case alone is worth more than the \$1.99. Get yours now—while they last. Circuit diagram and instruction book included. Shpg. wt. 7 lbs.

### SHOCK MOUNTING ASSEMBLY FOR AMPLIFIER—Shpg. wt. 1 lb.

Stock No. X-574, each. .... **49c**

SEE YOUR OLSON DEALER FOR COMPLETE LISTING OF DEALERS ON SHOCK MOUNTING ASSEMBLY ADVERTISED ITEMS.

### BRAND NEW TV PICTURE TUBES

Guaranteed A Full Year • Individually Boxed • No Trade-In Required • Keep Your Old Tubes • Guarantee Registration Card Included

Factory Sealed Cartons. Every one guaranteed a FULL year and every one is shipped with manufacturers registration warranty card. Tubes carry the famous Olson Akrad label. No need to send in old tubes on trade-in. You can keep them and sell locally.

All tubes are standard in every respect and have magnetic focus and deflection. Cash in now on this unheard of bargain. Guaranteed perfect arrival by Railway Express.

STOCK NO.	TYPE	OLSON SPECIAL
TU-8	10BP4	\$10.95
TU-3	12LP4	12.95
TU-4	16KP4	16.95
TU-5	16RP4	16.95
TU-6	16TP4	16.95
TU-7	17BP4A	17.95

### PHONO DRAWER SLIDE

Stock No. X-355  
List Price \$119

3 Fr. \$3.00

Made for expensive Dumont TV-Record Player combinations. Used to mount changers in cabinets. Heavy Duty Construction. 18" long with a capacity of 50 lbs. Reg. List \$4.00. Shpg. wt. Fr. 3 lbs.

### TELEPHONE SET

Sound Powered  
Includes Headset and Microphone

Stock No. M-98  
List Price \$395

2 Sets for \$7.50



Brand New—original cost \$30.00. No batteries needed—self powered. Permits 2-way talking up to 2 miles over any two-wire conductor. Each set contains a pair of sound powered high impedance dynamic headphones with felt padded rubber cushions and leather covered head-band. Both microphone and earphones have cone diaphragms and are extremely rugged and sensitive. Units may be removed from headsets to make efficient high powered miniature speakers. Useful for antenna installations where beaming of antenna is critical. Shpg. wt. 5 lbs.

### AUTOMATIC TIME SWITCH

Stock No. X-582  
List Price \$795

3 FOR \$22.00

Regular \$11.45. For accurate and dependable daily control of lights, fans, stokers, burners, valves, air conditioners, motors and other equipment where 2 or more on-off operations per day are required. Features synchronous clock type motor ensures years of dependable service. Heavy duty coin silver switch contacts handle up to 20 amps. Housed in heavy gauge grey wrinkle in-line drawn steel case with cover equipped with a hump for padlock. Complete with 2 sets of completely adjustable die cast trippers. For 110-120 Volts, 50-60 cycle. Shpg. wt. 6 lbs.

### TELEGRAPH KEY

Stock No. X-606  
List Price \$89c

ea.

Pure coin silver contacts, heavy brass hardware. Fully adjustable. Base has threaded bushings for permanent mounting. Shpg. wt. 1 lb.

### HOW TO ORDER

Mail your order to 279 E. Market St., Akron 8, Ohio. Send remittance with order (add for postage 5c for each dollar's worth) or send 10c for each dollar's worth if you are more than 1000 miles away). OLSON REFUNDS EVERY CENT NOT USED. Or—send no money—we'll ship C.O.D. and you pay mail or expressman for merchandise and postage. ALL MERCHANDISE 100% GUARANTEED. PLEASE—MINIMUM ORDER \$3.00.

### OLSON BARGAIN STORES IN:

- CHICAGO—623 W. Randolph St.
  - CLEVELAND—2020 Euclid Ave.
  - PITTSBURGH—5918 Penn. Ave.
  - MILWAUKEE—423 W. Michigan
  - BUFFALO—711 Main Street
- SEND FOR NEW FREE CATALOG

## OLSON RADIO WAREHOUSE 279 EAST MARKET ST. • AKRON 8, OHIO





**Get more money!  
More security! More out of life!**

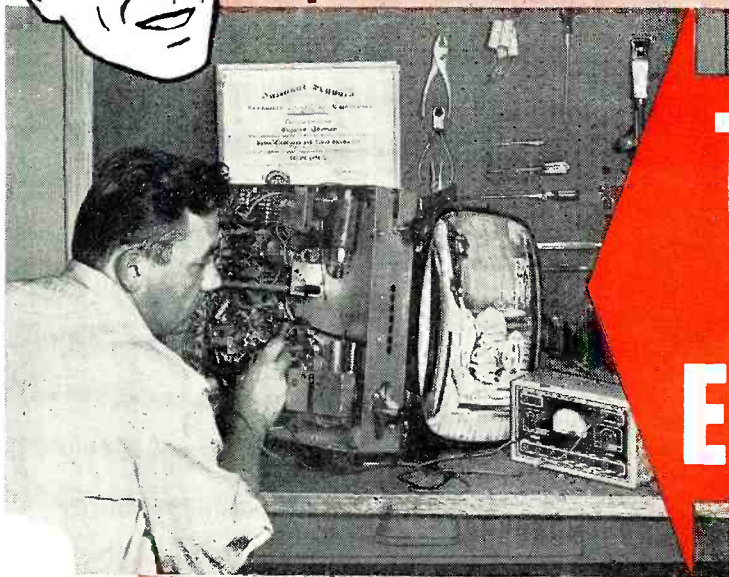

# Learn TELEVISION • RADIO • ELECTRONICS

**Get the best!**

## Get National Schools' SHOP-METHOD HOME TRAINING!

Start now! Why wait around for that raise or promotion that may never come? Get started *now* in high-paying TV-Radio-Electronics! National Schools' SHOP METHOD Home Training prepares you for success in a top-salary job or in your own business. You learn *all three*... Television, Radio, Electronics... in one complete course. Our Shop-Tested lessons and manuals help you master all phases in shortest possible time! Send coupon, find out today!

### WHY NATIONAL SCHOOLS LEADS THE FIELD

Located in the "Television Center" of the world, our staff is in close touch with latest developments and opportunities. We give you personalized job placement assistance. We also give you confidential help with both technical and personal problems relating to your training. We show you how to make Part Time Earnings as you progress. Whether you live 30 miles away, or 3,000, you will always be pleased with our prompt, friendly service!

**DRAFT AGE?** Our home training helps you achieve specialized ratings and higher pay grades if you go in service.

We send you this precision-tested Multitester! Plus parts to build Oscillators, Receivers, Signal Generator, Continuity Checker, Combination Short Wave and Standard

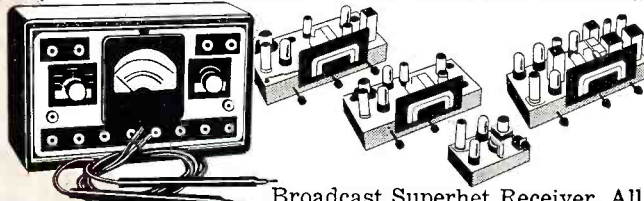

Broadcast Superhet Receiver. All this equipment is part of your National Schools course. **NO EXTRA CHARGES!** Send coupon for free books!

**NATIONAL SCHOOLS**, world-famous technical trade school. Now in our 50th year!



## NATIONAL SCHOOLS

**TECHNICAL TRADE TRAINING SINCE 1905**

LOS ANGELES 37, California • CHICAGO: 323 West Polk St.

IN CANADA: 811 West Hastings Street, Vancouver, B. C.

• APPROVED FOR G. I. TRAINING

• BOTH HOME STUDY AND RESIDENT COURSES OFFERED

### 30 MILLION TV SETS

need regular repair! Color TV means more sets than ever before. NOW is the golden opportunity to cash in on this multi-billion-dollar industry. Or "write your own ticket" in broadcasting, manufacturing, and other specialized phases!

**YOUR AGE**

**IS NO**

**OBSTACLE!**

**Send for  
FREE LESSON!**

**FREE BOOK & SAMPLE LESSON  
will convince you!**

**SEND COUPON TODAY!**

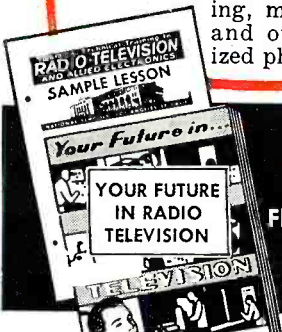

### MAIL NOW TO OFFICE NEAREST YOU!

(mail in envelope or paste on postal card)

**NATIONAL SCHOOLS, Dept. RH-16**

4000 SOUTH FIGUEROA STREET  
LOS ANGELES 37, CALIFORNIA

OR 323 WEST POLK STREET  
CHICAGO 7, ILLINOIS

Please rush **FREE BOOK**, "My Future in Radio-Television-Electronics," and **FREE LESSON** at once. I understand there is no obligation, and no salesman will call.

NAME \_\_\_\_\_ BIRTHDAY \_\_\_\_\_ 19 \_\_\_\_\_

ADDRESS \_\_\_\_\_

CITY \_\_\_\_\_ ZONE \_\_\_\_\_ STATE \_\_\_\_\_

Check if interested **ONLY** in Resident Training at Los Angeles.

VETERANS: Give date of discharge \_\_\_\_\_



# Here's the new G-E CONVERTIBLE HI-FI AMPLIFIER



**Pure 20-Watt Undistorted Output  
Exclusive Dual Chassis Design**

The exciting new *Convertible* is dramatic in performance—flexible in design. 20 watts of pure, undistorted output is only part of the *Convertible's* promise. Other new quality features include a 7-knob control panel, built-in rumble filter, 8-position selector/compensator, 5 inputs and 4 outputs for every audio need, and a power-on indicator pilot lamp. Truly, this remarkable instrument was designed for the most discriminating audio fan.

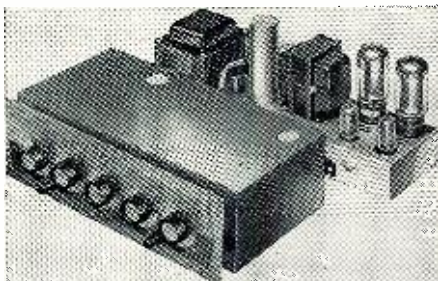

**DUAL CHASSIS DESIGN.** Two complete chassis function as one unit in a handsome metal cabinet . . . or may be custom-mounted separately.

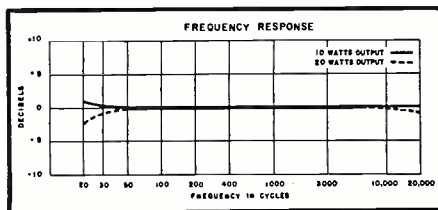

**20 WATTS UNDISTORTED OUTPUT.** Frequency response curve is flat all the way out.  $\pm 1$  db 20 cps to 20 KC at 1/10 power and  $\pm 2$  db 30 cps to 15 KC at  $\frac{1}{2}$  power.

Listen to G.E.'s remarkable new *Convertible* at your hi-fi dealers'. Or, write: General Electric Co., Radio & TV Dept., Section R1516, Electronics Park, Syracuse, N. Y.

*Progress Is Our Most Important Product*

**GENERAL ELECTRIC**

# Within the Industry

**ROBERT L. WOLFF** has been elected vice-president in charge of engineering for the *Centralab Division of Globe-Union Inc.*

He has been with the company since 1937 and has been director of product engineering since 1951.



At the same time Mr. Wolff's promotion was announced, the company also made public the appointment of W. S. Clark as division manager of the firm's "Badger" plant and of R. C. Anderson to a similar post at the "Keefe" plant.

\* \* \*

**JOSEPH A. DeMAMBRO** of *DeMambro Radio Supply Co.*, Boston, has been elected president of the National Electronic Distributors Association (NEDA).

Serving with the new president will be Aaron Lippman of Newark, N. J. who was re-elected chairman of the board by acclamation. Other officers of the trade association include Leo I. Meyerson, *World Radio Laboratories, Inc.*, Council Bluffs, Iowa, first vice-president; Byron C. Deadman, *Northern Radio & Television Co.*, Green Bay, Wis., second vice-president; Victor N. Zachariah, *Zack Radio Supply Co.*, San Francisco, treasurer; and Meyer J. Spiro, *Meyers Electronics, Inc.*, Bluefield, W. Va., secretary.

L. B. Calamaras was re-appointed executive vice-president for a two-year term. The association maintains headquarters at 4704 W. Irving Park Road, Chicago 41, Illinois.

\* \* \*

**JACK WHITESIDE**, general manager of *Simpson Electric Co.* of Chicago, has been promoted to the post of vice-president of the parent company, *American Gage & Machine Co.* in charge of the *Simpson Electric Division*.

Before joining the firm in 1945 he was employed in the laboratory of *General Electric Company* at Nela Park from 1936 to 1941 and at the Radiation Laboratory at MIT from 1941 to 1945.

He joined *Simpson* as a development engineer and was promoted to the post of general manager in September 1945.

\* \* \*

**EITEL-McCULLOUGH, INC.** will add a new 17,000 square foot building, which will include facilities for the production of super klystron amplifier tubes up to twenty feet long, to its main San

Bruno, California plant. Present plans call for completion of the building in early spring . . . **BRISTOL ENGINEERING CORPORATION** has negotiated a long-term lease on a three-story factory building in downtown Bristol, Pa. which will double its present working area . . . A five-million-dollar expansion program has begun at the main plant and offices of **STROMBERG-CARLSON COMPANY**, a division of **GENERAL DYNAMICS CORPORATION**. The program will add more than a quarter of a million square feet of floor space . . . **CBS-HYTRON** will build a completely modern 55,000 square foot warehouse in Chicago at Mannheim Road in Melrose Park. The new facility will be used to speed tube and transistor deliveries to dealers and distributors in the midwest . . . **SAMUEL KASS INC.**, New York jobber, has moved to new and larger quarters at 59-63 Moore Street, near Hudson Street, in New York City. The new location has 30,000 square feet of space.

\* \* \*

**SAM SCHLUSSEL** has been named to the newly-created post of sales manager, antennas and accessories, for *Channel Master Corp.*, Ellenville, New York manufacturer of antennas and antenna equipment.



Mr. Schluszel joined the firm five years ago as a project engineer in the antenna laboratory during which time he was responsible for the development of several of the company's best-selling antennas.

He was later named chief field and sales engineer and in this capacity was active in research, promotion, field testing, sales training, dealer education, and distributor relations.

\* \* \*

**AMERICAN RELAY & CONTROLS, INC.** has been merged with **OHMITE MANUFACTURING COMPANY**. The parent firm will now manufacture the "Amrecon" relay line . . . **MUSICRAFT** has been established at 48 East Oak Street to handle the sale, installation, and servicing of high-fidelity equipment. The firm occupies all of the 7000 square feet of space in a remodeled four-story residence building on Chicago's near north side . . . **V. D. WALKER AND ASSOCIATES** has been established at 15219 Sunset Blvd., Pacific Palisades, California to offer counseling in all phases of industrial marketing . . . David Hafler has announced the formation of a new organization, **DYNA COMPANY**, with headquarters at 5142 Master Street, Philadelphia 31, Pa. Under the



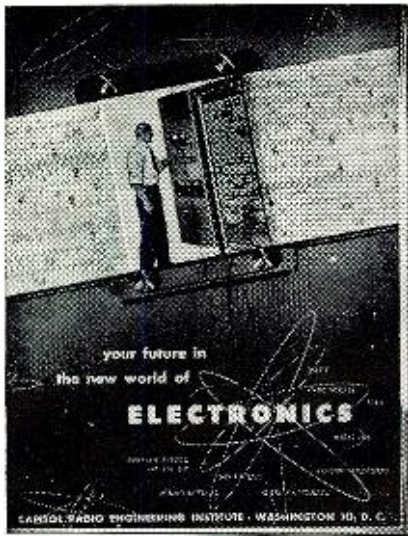

# The data that Launched Thousands of Careers is Yours FREE to show

## HOW YOU CAN BE SUCCESSFUL IN RADIO-TV-ELECTRONICS

Send for Your Booklet Today!

**Y**OU CAN plod along for years, getting a paltry increase now and then, enjoying little security, finding your work dull and drab.

Then something happens. Things look up. You become more confident. Your earnings rise. You feel more important.

"Luck," some may say.

"Contacts," others may suggest.

But in your heart, you will know the answer: "Training." And it all may have started the moment you filled out a coupon requesting a copy of a free booklet named "Your Future in the New World of Electronics." From this data you get knowledge of where you stand in Electronics. Tremendous expansion leaves this gigantic industry pleading for trained men. Top manufacturers sold billions of dollars worth of electronic merchandise in 1955. By 1960, the radio-electronics industry should do no less than 10 billion dollars per year, not counting military orders.

Today there are over 97,000 radio-equipped police cars; at least 87,000 taxis are radio equipped; 37,730 civilian planes have radio; 35,000 American ships have radio.

Today there are over 122,000,000 radios in use. There are 37,000,000 TV sets and 413 TV stations in operation. Color TV is coming into its own. Countless positions must be filled—in development, research, design, production, testing and inspection, manufacture, broadcasting, telecasting and servicing. To fill these posts trained men are needed—men who somewhere along the line take time to improve their knowledge, their skills. Men who, today, perhaps, take two minutes to send for a booklet.

"Your Future in the New World of Electronics" shows you how CREI Home Study leads the way to greater earnings through the inviting opportunities described above.

However, CREI does not promise you a "snap." With an accredited technical school such as this, you must *study* to convert your ambition into technical knowledge you can sell in the fabulous Electronics market.

Since its founding in 1927, CREI has provided thousands of professional radio men with technical educations. During World War II CREI trained thousands for the Armed Services. Leading firms choose CREI courses for group training in electronics, at company

January, 1956

expense, among them United Air Lines, Canadian Broadcasting Corporation, Trans-Canada Airlines, Sears, Roebuck and Co., Bendix Products Division, All-American Cables and Radio, Inc., and Radio Corporation of America.

CREI courses are prepared by recognized experts in a practical, easily understood manner. You get the benefit of time-tested materials, under the personal supervision of a CREI Staff Instructor, who *knows* and *teaches* you what industry wants. This is accomplished on your own time, during hours selected by you, and controlled by your own will power. This complete training is the reason that graduates find their CREI diplomas keys-to-success in Radio, TV and Electronics. CREI alumni hold top positions in America's leading firms. At your service is the CREI Placement Bureau, which finds positions for advanced students and graduates. Although CREI does not guarantee jobs, requests for personnel far exceed current supply.

Now is the time of decision for you. Luck will not propel you forward unless it finds you trained. Contacts won't budge you an inch unless you have the skill to back them up. The answer is: Technical Training . . . and willingness to learn. Together they will bring you increased earning in this new Age of Electronics. Fill out the coupon below and mail it now. We'll

promptly send you your free copy of "Your Future in the New World of Electronics." The rest—your future—is up to you.

CREI resident instruction (day or night) is offered in Washington, D. C. New classes start once a month.

**VETERANS:** If you were discharged after June 27, 1950—let the new G.I. Bill of Rights help you obtain CREI resident instruction. Check the coupon for full information.

**MAIL THIS COUPON Today!**

### CAPITOL RADIO ENGINEERING INSTITUTE

Accredited Technical Institute Curricula  
DEPT. 111-C, 3224 16TH ST., N. W., WASHINGTON 10, D. C.

Please send me your course outline and FREE Illustrated Booklet "Your Future in the New World of Electronics" . . . describing opportunities and CREI home study courses in Practical Electronics Engineering.

**CHECK FIELD OF GREATEST INTEREST**  Practical Radio Electronics Engineering **B**  
 Broadcast Radio Engineering (AM, FM, TV)  
 Practical Television Engineering  
 Practical Aeronautical Electronics Engineering

Name .....

Street .....

City..... Zone..... State.....

CHECK:  Home Study  Residence School  Veteran



To help us answer your request intelligently, please give the following information:

EMPLOYED BY.....  
.....  
TYPE OF PRESENT WORK.....  
.....  
SCHOOL BACKGROUND.....  
.....  
ELECTRONICS EXPERIENCE.....  
.....  
IN WHAT BRANCH OF ELECTRONICS ARE YOU MOST INTERESTED?  
.....  
.....



**A TURNTABLE FOR THE HOME, BUILT TO FAIRCHILD'S STUDIO EQUIPMENT STANDARDS!**



*Fairchild engineering  
... Loewy styling!*

# FAIRCHILD

## Turromatic TURNTABLE

**F**airchild, now in its third decade of supplying equipment to meet the most exacting standards of recording and broadcasting studios throughout the world, presents for the first time a home turntable of compatible excellence.

You would naturally expect superlative performance in a table from Fairchild, and the new "411" gives it. Vibrationless operation makes possible utilization of the full dynamic range of modern LP recordings; its rumble content is actually lower than that of most records. The Turromatic's absence of reproduced noise is matched only by its complete acoustical silence — you will only know by the soft illumination that it is running! Flutter and wow are no longer a consideration, being completely imperceptible (typical measurements: less than 0.07% RMS at 78 and less than 0.1% at 33).

All bearings poured babbitt precision rifle-drilled for highest polish. (Babbitt running on polished, hardened steel is still the smoothest, most quiet, and most durable bearing devised.) Thrust bearing is ROTATING polished steel ball turning on nylon seat . . . self-adjusting, self-aligning, practically wear-free. Main bearing sealed to shaft—no one (including you!) can mar its mirror-like surface after assembly and final test.

### Automatic Idler Pressure

**Release — no flats on idlers ever!** Unless you remember to "turn the switch to the off position", most turntables (probably yours) will develop "flat" spots on the idler. This naturally results in greatly deteriorated performance. With the Fairchild Automatic Pressure Release such damage is impossible. Since pressure is applied to idlers only when motor current is on, you can safely shut off the "411" from any remote point — for example, at the main control or by clock switch for lazy listening.

### Turret Control

The "411" takes full advantage of all the smooth performance inherent in silent, flexible, endless-belt drive. But also, step-pulley type idlers in an ingenious turret mounting provide:

1. Instantaneous, silent, fool-proof speed shift
2. Greatly increased driving surface for positive non-slip drive.

### OTHER FEATURES:

**TWO STAGES** of motor isolation from frame and turntable.

Polished aluminum turntable, non-magnetic. Heavy cast-iron flywheel for greatest stability and smoothness of motion.

Built-in "45" center raises or lowers quickly and easily.

Clearance provided for playing 16" transcriptions with appropriate arm.

For the full story . . . see your nearest Hi-Fi dealer or write:

**FAIRCHILD Recording Equipment Co., Whitestone, N. Y.**

tradenames "Dynaco" and "Dynakit," the company will design and produce electronic components and equipment with particular emphasis on audio items for the high-fidelity market.

**PERRY C. SMITH** has been appointed manager of the Equipment Department of *Brush Electronics Company*, Cleveland.



Mr. Smith, who joined the company early in 1955, was formerly general manager of the Electronics Instruments Division of the *Burroughs Corporation*. Prior to that he was manager of Scientific Instruments Engineering for the *Radio Corporation of America* in Camden.

In his new post he will direct the sales activities of the department which includes recording systems, amplifiers and direct-writing oscillographs, sound measurement instruments, industrial inspection equipment, and computer and tape storage devices.

**FREDERICK D. OGILBY** has been appointed vice-president, marketing, for *Philco Corporation*. He has been with the firm for over 20 years . . . **WILLIAM P. MAGINNIS** has been elected president of *Kuthe Laboratories, Inc.* of Newark, N.J. a subsidiary of *International Telephone and Telegraph Corporation*. He succeeds **DR. HERMAN KUTHE**, founder and first president, who has been elevated to chairman of the board . . . *Hoffman Electronics Corporation* has elevated **PAUL E. BRYANT** to the post of general sales manager of its radio division . . . *Brush Electronics Company Division* has named **JOHN H. HARRIS** to the post of vice-president in charge of planning and **WALLACE T. GRAY** general works manager . . . **A. ERIC THEIS** is now vice-president in charge of manufacturing, **CHARLES F. HEALEY** is vice-president in charge of administration, and **H. GORDON HAWTHORNE** is treasurer of *Servo Corporation of America* . . . *International Resistance Company* has appointed **GUY B. ENTREKIN** to the post of plant manager of its fifth and newest manufacturing branch plant located in Burlington, Iowa . . . **J. KNEELAND NUNAN** has been named to the new post of vice-president and general manager of the *Clevite Research Center* in Cleveland . . . *El-Tronics, Inc.* of Philadelphia has appointed **ARNOLD A. ZACHOW** to the post of vice-president in charge of operations . . . **ROBERT O. VAUGHN**, nationally-known electronics executive, has joined *National Aircraft Corporation* as vice-president. He was formerly with *Hoffman Laboratories, Inc.* . . . *Haydu Brothers*, a *Burroughs Corporation* subsidiary, has named **ARTHUR B. SHESSER** to the post of director of sales and **FRANK G. FERDINAND** to the position of sales manager of the cathode-ray tube division . . . **ALLEN S. JOHNSON** has joined the electronics division of *Thompson Products, Inc.* as assistant to the divi-



**Where voices are  
powered  
by the sun**

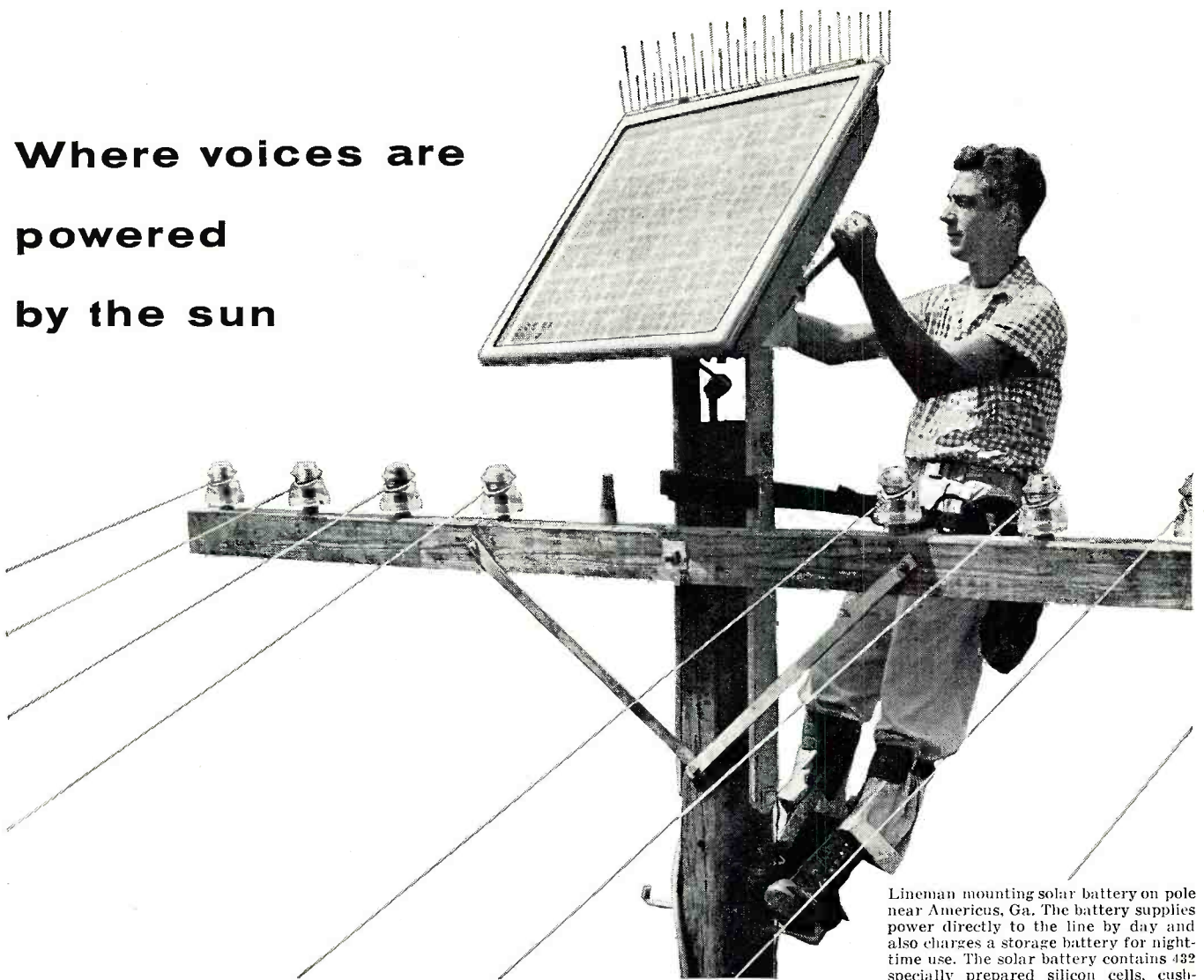

Lineman mounting solar battery on pole near Americus, Ga. The battery supplies power directly to the line by day and also charges a storage battery for night-time use. The solar battery contains 432 specially prepared silicon cells, cushioned in oil and covered by glass.

A new kind of telephone system developed by Bell Telephone Laboratories for rural areas is being operated experimentally by electric current derived from sunlight. Electric current is generated as sunlight falls on the Bell Solar Battery, which a lineman is seen adjusting in position.

The exciting achievement is made possible by two Laboratories inventions—the solar battery and the transistor. The new system uses transistors to the complete exclusion of electron tubes.

Transistors require little power and this power can be easily supplied by the solar battery.

Compact and economical, the transistorized system can carry several voices simultaneously without interference. It has proved its ruggedness by standing up to heat, cold, rain and lightning. It promises more and improved telephone service for rural areas and it typifies the Laboratories' continuing efforts to make American telephony still better each year.

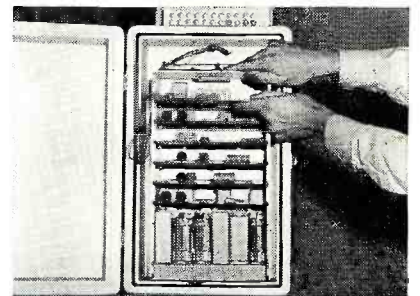

In sending and receiving terminals, transistors are used as oscillators, amplifiers and regulators, and for signaling.

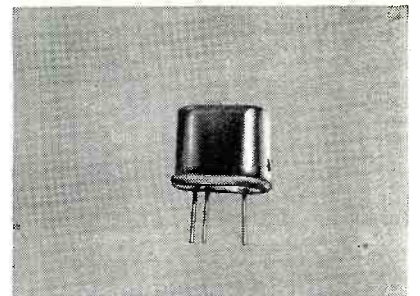

One of the transistors (actual size) used in the new system. New ideas, new tools, new equipment and new methods had to be developed for this project.

**BELL TELEPHONE LABORATORIES**

IMPROVING AMERICA'S TELEPHONE SERVICE PROVIDES CAREERS  
FOR CREATIVE MEN IN SCIENTIFIC AND TECHNICAL FIELDS





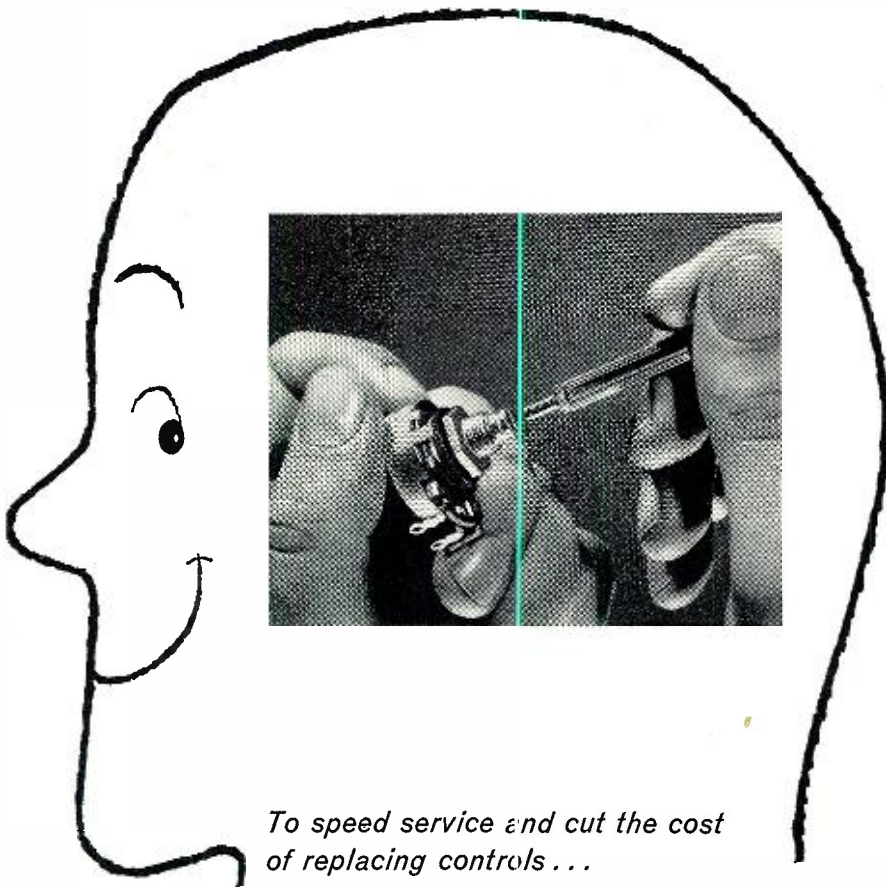

To speed service and cut the cost of replacing controls...

## It pays to think of Centralab Adashaft® Radiohms®

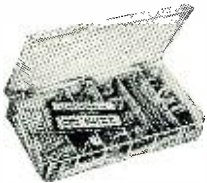

### ADASHAFT KIT NO. AB-100

An assortment of 39 most popular controls, switches, shafts, shaft extensions, and couplers. In hinged-lid plastic box. \$15.03 suggested net price.

Patented Adashaft design gives you *any resistance*

— including dual-tapped types . . .

*with any shaft*

12 basic shaft types from 3/8" to 10" long, including auto types, insulating nylon, many others

*...and you can convert to switch types with Centralab "Fastatch" type KB line switches.*

Order Adashaft controls from your Centralab distributor. Both control *and* shaft cost no more than an ordinary control alone.

Send coupon for bulletin 42-199.

# Centralab

A DIVISION OF GLOBE-UNION INC.  
910A E. Keefe Avenue, Milwaukee 1, Wisconsin  
Send me Centralab bulletin 42-199.

B-561

Name.....

Company.....

Address.....

City..... (.....) State.....

sion's manager. He was formerly with Webster-Chicago Corp. of Chicago . . . National Company has appointed **MARTIN W. ROGERS** to the post of director of quality control. He formerly held a similar post at Raytheon . . . Fanon Electric Co., Inc. has named **WALTER NACHTIGALL** to the newly-created post of advertising and sales manager for the audio firm . . . **VICE ADMIRAL CHARLES B. MOMSEN, USN (ret.)** has been engaged by General Dynamics Corporation to serve as a consultant in the firm's widespread activities. He will be available to work with engineers and designers of the Stromberg-Carlson Company on problems of marine applications of communication and electronics equipment . . . **CARL V. HAECKER**, sales promotion and displays manager for the Radio Corporation of America, died recently of a heart condition. He was a nationally-known authority on store merchandising, promotions, and point-of-sale displays . . . Erie Resistor Corporation has appointed **JAMES H. FOSTER** to the post of general manager of its expanding electro-mechanical division. He has been with the firm for five years . . . **EDWARD L. NELSON**, scientific chief of research and development for the Army Signal Corps, died recently of a heart attack at the age of 64 . . . **REAR ADMIRAL ERNEST ST. C. VON KLEECK**, former chief of staff and aide to the commandant of the Fourth Naval District, has been named assistant to the president of El-Tronics, Inc. . . . **J. E. VAN WAGENEN**, formerly sales manager of the company's semi-conductor products division, has been upped to the post of selenium product line manager for Federal Telephone and Telegraph Corporation of Clifton, N. J. . . . **JERRY MERICAN** has resigned as President and Sales Manager of Precise Development Company, Oceanside, N. Y. His immediate plans are indefinite, although he will remain in the electronics field . . . **OLIVER MUELLER** has been appointed Chief Engineer of the Aircraft Controls Division, Gorn Electric Co., Stamford, Conn.

\* \* \*

**CHARLES McKINNEY** has been appointed director of market-merchandising for both the tape recorder and background music divisions of Magnecord, Inc. His appointment is part of recent management plans for increased national distribution and promotional activity for both divisions.



Mr. McKinney will continue as director of advertising and public relations for the firm in addition to assuming his new duties. He was associated with Raytheon in a like post before joining the firm and prior to that operated his own merchandising and marketing firm in Chicago.

\* \* \*

**ALMO RADIO CO.** will sponsor its Third (Continued on page 152)

**RADIO & TELEVISION NEWS**



Prepare for a Good Paying Job — Or Your Own Business

Learn **PRACTICAL RADIO-TV**  
with **25 BIG KITS**

of equipment I send you while  
you train with me . . . for valuable  
shop bench experience . . .

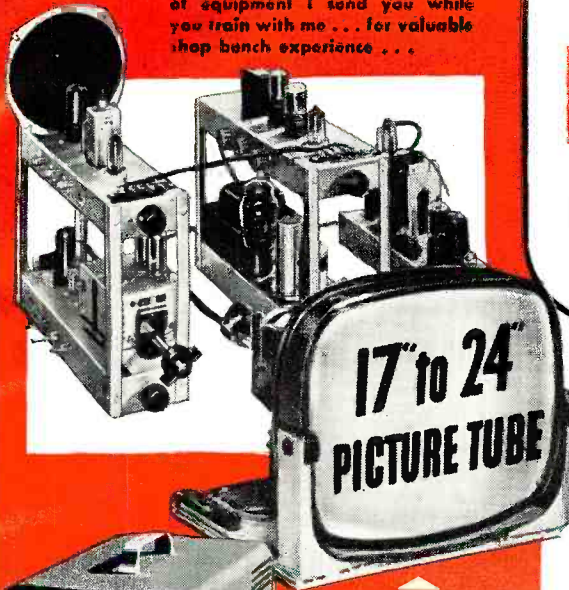

This is the new Sprayberry Training  
Television receiver, built and tested  
in sections for greatest instruction  
value.

I now offer this fine modern oscil-  
loscope to help you learn practical  
Television servicing.

You will build this powerful short  
wave and broadcast superhet radio  
receiver for valuable shop instruc-  
tion practice.

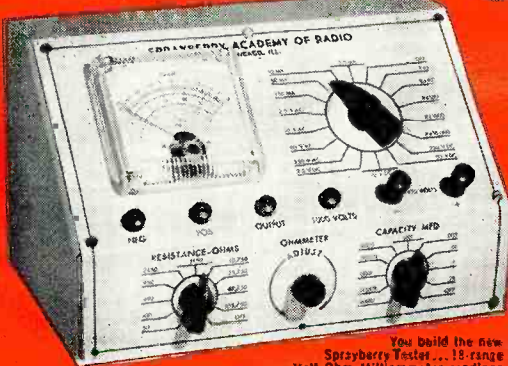
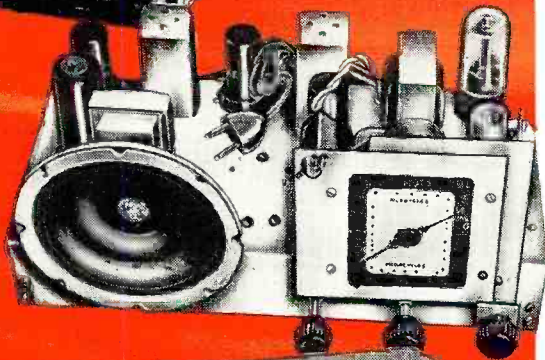

You build the new  
Sprayberry Tester . . . 18 range  
Volt-Ohm-Milliammeter readings  
plus output meter and condenser  
and resistor substitution selector.

In addition to modern lesson training, I also give you  
plenty of home practice on actual Radio-Television  
equipment . . . you will build and use the units shown  
here plus many more. All this equipment is yours to  
keep . . . keep everything you need to set up your shop.

"I Will Train You at Home in  
**RADIO-TELEVISION**  
On Liberal No Obligation Plan!"

**New Equipment! New Lessons! Enlarged  
Course! The true facts are yours in my  
big new catalog . . . YOURS FREE . . .  
JUST MAIL COUPON!**



Frank L. Sprayberry  
President, Sprayberry  
Academy of Radio

I can train and prepare you in as little as  
10 months to step into the big opportunity  
Radio-Television service field. Train *without*  
signing a binding contract . . . without obli-  
gating yourself to pay any regular monthly  
amounts. You train entirely at home in spare  
hours . . . you train as fast or as slowly as  
you wish. You'll have your choice of **THREE SPRAYBERRY TRAINING  
PLANS** . . . planned for both beginners as well as the more experienced  
man. Get the true facts about the finest most modern Radio-Training avail-  
able today . . . just mail the coupon for my big new 56 page fact-filled  
catalog plus sample lesson—both **FREE**.

**Train the Practical Way—with Actual Radio-Television Equipment**

My students do better because I train both the mind and the hands. Sprayberry  
Training is offered in 25 individual training units, each includes a practice giving  
kit of parts and equipment . . . all yours to keep. You will gain priceless practical  
experience building the specially engineered Sprayberry Television Training Re-  
ceiver, Two-Band Radio Set, Signal Generator, Audio Tester and the new Spray-  
berry 18 range Multi-Tester, plus other test units. You will have a complete set  
of Radio-TV test equipment to start your own shop. My lessons are regularly  
revised and every important new development is covered. My students are com-  
pletely trained Radio-Television Service Technicians.

**NEWEST  
DEVELOPMENTS**

Your training  
covers U H F, Color  
Television, F M,  
Oscilloscope  
Servicing, High  
Fidelity Sound  
and Transistors.

**See for Yourself . . . Make Your Own Decision  
. . . Mail Coupon Today!**

The coupon below brings you my big new catalog plus  
an actual sample Sprayberry Lesson. I invite you to read  
the facts . . . to see that I actually illustrate every item  
I include in my training. With the facts in your hands,  
you will be able to decide. *No salesman will call on you.*  
The coupon places you under no obligation. Mail it now,  
today, and get ready for your place in Radio-Television.

**SPRAYBERRY ACADEMY OF RADIO**  
111 North Canal Street, Dept. 25-G, Chicago 6, Illinois

**Mail This Coupon For Free Facts and Sample Lesson**

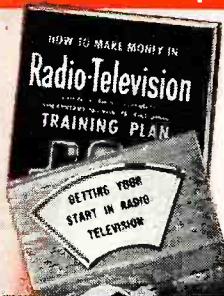

**SPRAYBERRY ACADEMY OF RADIO**  
Dept. 25-G, 111 N. Canal St., Chicago 6, Ill.

Please rush all information on your **ALL-NEW** Radio-Tele-  
vision Training Plan. I understand this does not obligate me  
and that no salesman will call upon me. Include New Cata-  
log and Sample Lesson **FREE**.

Name \_\_\_\_\_ Age \_\_\_\_\_  
Address \_\_\_\_\_  
City \_\_\_\_\_ Zone \_\_\_\_\_ State \_\_\_\_\_



HANDLE YOUR REPLACEMENTS FOR OVER 110 TYPES OF PICTURE  
TUBES WITH JUST 25 TYPES...TYPES IN THE GREAT NEW LINE OF

# RCA Silverama

**SUPER-ALUMINIZED PICTURE TUBES**

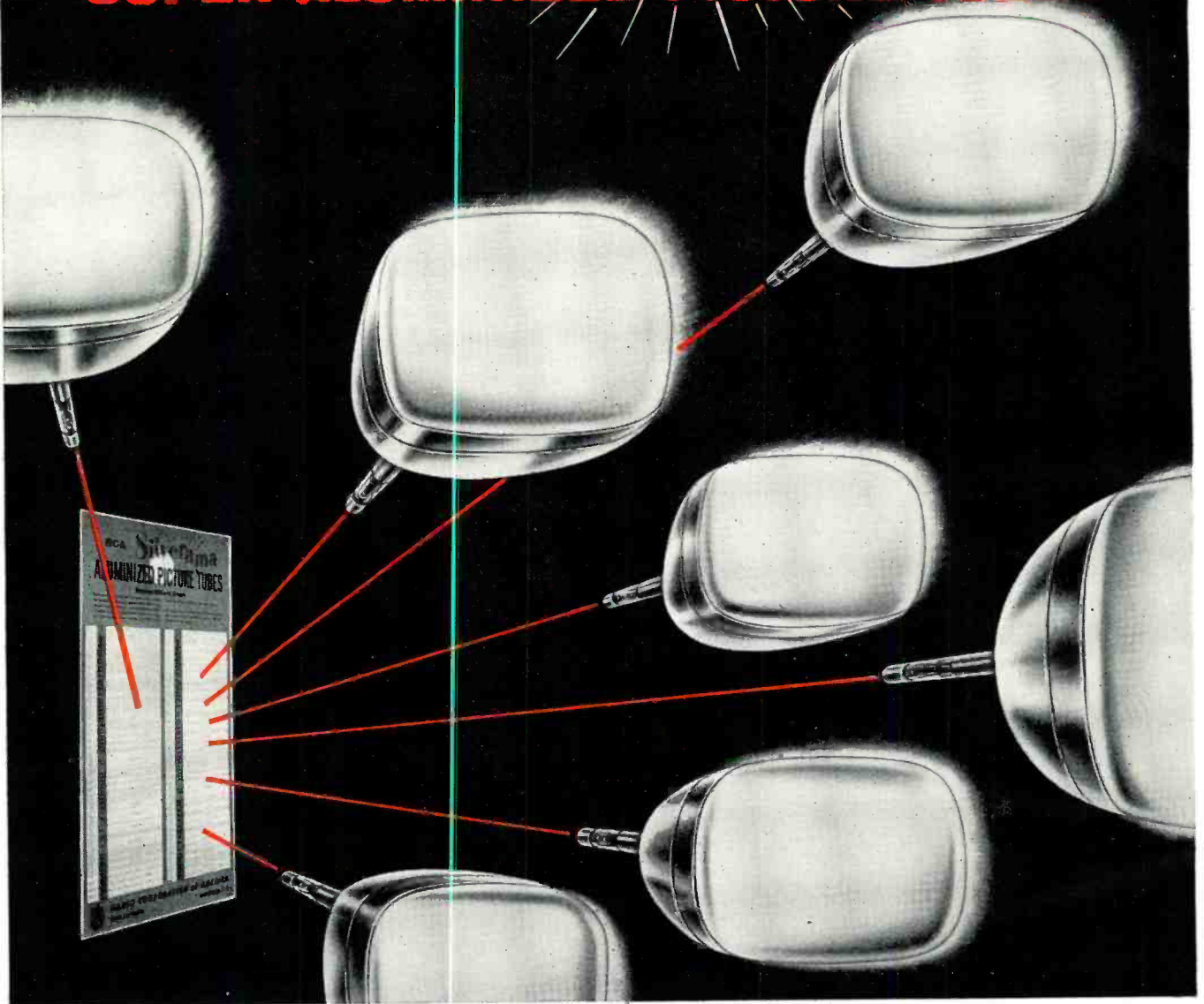

**25 types—8 sizes—10" to 27"**

RCA's new Silverama Replacement Chart—yours, for the asking—tells you at a glance what RCA Silverama Picture Tubes to use when making replacements, no matter what model or make set you're servicing. And every Silverama insures a brighter, clearer, sharper picture with greater contrast. Just wait 'til your customers view the new life you've given to their sets with Silverama Aluminized Picture Tubes! See your local RCA Distributor for full details, or write to Commercial Engineering, RCA Tube Division, Harrison, N. J., for form 4F909.

*You profit while you please—with RCA Silverama.*



**PICTURE TUBES**

RADIO CORPORATION OF AMERICA • HARRISON, N. J.



# Electronics-Horizons Unlimited

## a Guest Editorial

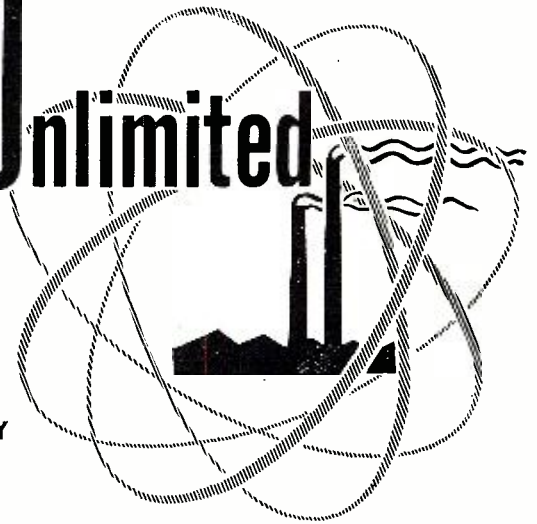

By **MICHAEL KOURDAY**  
Investment Research Dept.  
E. F. Hutton & Company

*The radio-electronics industry, although big, is still young. Within the next ten years it should boast a sales volume of at least 20 billion dollars.*

**T**O A NON-TECHNICAL observer of the electronics field, the single factor which makes it completely unique and fascinating is its capacity for almost infinite growth. Bound only by the limits of the mind of man, this infant industry has already far surpassed early expectations. By establishing a pattern of renewing its vigor through the periodic development of new aspects, it has assured itself of a continuing future. Despite its youth, electronics already ranks as one of our foremost industries, with an annual sales volume of \$9 to \$10 billion. Notwithstanding this remarkable record of growth, electronics can still be considered to be in the formative stages. Many observers predict that the industry will be able to boast a sales volume of \$20 billion within the next ten years.

That such tremendous growth is entirely possible, indeed probable, may be discovered through a study of some of the facets of the electronics field. An examination of its major areas of operation offer clear evidence of the overall growth potential. These areas include: (1) radio manufacturing, (2) television manufacturing, (3) military electronics, (4) industrial electronics, (5) servicing and parts, and (6) broadcasting.

### Radio—The Electronics Pioneer

Although the electronics industry was born in 1906 when Dr. DeForest invented the vacuum tube, it was the application of this tube in radio which provided the industry with its initial impetus. In 1919, when radio was still in the cradle stage, its annual sales were estimated to be in the area of \$2 million. A decade later, 4.2 million sets valued at about \$600 million were sold. Although mass production techniques soon resulted in declining dollar values, the number of sets sold continued to increase substantially, reaching a peak of 17 million in 1947. Inevitably, a saturation point was reached, and today, with an estimated 130 million receivers in use, radio no longer offers growth prospects. The importance of radio, however, in the total electronics picture should not be underestimated since normal demand, combined with a large replacement market, can support a sales volume of

between \$250 million and \$300 million annually.

### TV—Radio's Successor

Although radio expanded airplane fast, television by comparison seems to have been jet-propelled. In just three years, the television industry became a \$1 billion business, rising from \$50 million in sales at the factory level in 1947 to \$1.3 billion in 1950. By way of contrast, it took the auto industry ten years and the commercial airlines 25 years to reach the \$1 billion mark.

More important is the fact that TV's future is still extremely promising. For one thing, it can be expected that almost all of the nation's 47 million radio set homes will one day have a television set also—a potential market of 15 million TV sets. Also, the TV industry has reached an age where the obsolescence factor has become operative. A replacement demand of only 5% (due to obsolescence on the estimated 34 million sets now in use) will call for sales of 1.7 million sets. An added boost will be the introduction of a second set in many homes which should entail the sale of some 300,000 sets annually.

While these factors give considerable brightness to the future of TV, the real sparkle is added by the imminence of color. Although the high price makes it questionable as to just when this aspect will come into its own, it is almost certain that within the next ten years color TV will account for more than half of all sets manufactured. In 1955 it is expected that some 7.9 million receivers will be sold. With slightly higher prices (necessitated by rising material costs) 1955 should prove to be an outstanding year.

Undoubtedly, television will continue to be an important contributor to the electronics industry's growth for some time to come. After the sales saturation point has been reached, a continuing market will be provided by the fact that the normal replacement for TV will enable the industry to enjoy sales of about \$1.5 billion to \$2 billion annually—which would compare with a current sales volume at the manufacturing level of about \$1 billion.

### Military Electronics

The largest share of the electronics industry's products goes to feed the vast demands of modern "push-button" warfare. It is estimated that the military spends about 6% of its funds for electronic equipment, amounting to roughly \$2.5 billion annually.

Although a good part of electronics' role in armaments is classified, its application in such items as airplanes, guided missiles, proximity fuses, and gunfire control systems is well known. In today's airplane, for instance, electronic products represent about half of the total value of the plane. In a modern bomber there may be found some 5000 tubes and 115,000 resistors and capacitors. Some of the functions which these electronic devices are able to perform are truly astounding. One such marvel is the computer, which is capable of piloting aircraft automatically, from takeoff to landing, on split-second scheduling.

As the electronics field continues to expand, the demand from this source is expected to grow rapidly. Estimates of foreseeable military requirements indicate government purchases of \$3.2 billion a year in 1958-1960 and better

*(Continued on page 111)*



# Do you OVERPAY for QUALITY instruments?

EICO's mass purchasing and world-wide distribution, together with advanced electronic design, produce values never before possible . . . to give you Laboratory Precision at Lowest Cost!

GET the MOST for YOUR MONEY! Don't buy ANY test instrument till you put the EICO INSTRUMENT (kit or wired) equivalent before you—and . . .

Compare advanced electronic design: see the latest in circuitry and features.

Compare finest components: see the famous brands you know and trust, such as GE, Centralab, Mallory, etc.

Notice ease of construction and operation: Exclusive "Beginner-Tested" Manuals make assembly and operation step-by-step, quick, crystal-clear. "You build them in one evening—they last a lifetime!"

Check 5-Way Guarantee: Only EICO gives you this exclusive complete protection! EICO guarantees components, instructions and satisfactory operation — AND guarantees service and calibration for the LIFETIME of the instrument, at less than cost of handling.

Compare feature for feature, dollar for dollar.

There's an EICO distributor right nearby in your own neighborhood — over 1200 coast-to-coast. EICO planned it that way so that you can easily examine EICO BEFORE YOU PUT DOWN ONE CENT OF YOUR MONEY!

COMPARE any of EICO's 46 models SIDE BY SIDE with ANY competitor. Then YOU judge who's giving you the MOST for your money.

Over 500,000 EICO instruments in use . . . You'll agree EICO gives you LABORATORY PRECISION AT LOWEST COST.



## FREE 1956 EICO CATALOG!

Tells you how to SAVE 50% on  
your test equipment costs!

### NEW RF SIGNAL GENERATOR #324



**KIT \$26.95**  
Wired \$39.95  
Ill. dial

150 kc-435 mc; 6 fund. bands.



**NEW WIDE BAND DC-5MC 5" OSCILLOSCOPE #460**  
**KIT \$79.95**  
Wired \$129.50  
Designed for color TV servicing & laboratory use. DC vert. amplifier, flat DC-4.5 mc.



**5" PUSH-PULL OSCILLOSCOPE #425**  
**KIT \$44.95**  
Wired \$79.95  
**7" PUSH-PULL OSCILLOSCOPE #470**  
**KIT \$79.95**  
Wired \$129.50



**VACUUM TUBE VOLTMETER #221**  
**KIT \$25.95**  
Wired \$39.95  
**DELUXE VTVM #214 (7 1/2" METER)**  
**KIT \$34.95**  
Wired \$54.95



**#232 Peak-to-Peak VTVM with AC/DC UNI-PROBE (pat. pend.)**  
**KIT \$29.95**  
Wired \$49.95  
**Deluxe #249 with 7 1/2" Meter**  
**KIT \$39.95**  
Wired \$59.95



**TUBE TESTER #625**  
**KIT \$34.95**  
Wired \$49.95  
• tests 600 mil series string type tubes  
illuminated roll-chart  
**Pix Tube Test Adapter** .....\$4.50



**#944 FLYBACK TRANSFORMER & YOKE TESTER**  
**KIT \$23.95**  
Wired \$34.95  
• fast check all flybacks & yokes in or out of set.  
• spots even 1 shorted turn!



Range 500 kc-228 mc on fund. Cont. sweep width control, 0-30 mc.  
**KIT \$34.95**  
Wired \$49.95

**TV/FM SWEEP GENERATOR #360**  
SMC-4.5MC CRYSTAL ..... \$3.95 ea.

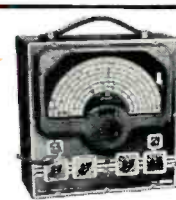

1% accuracy on all 7 ranges. Range 75 kc-150 mc. Volt reg.  
**KIT \$39.95**  
Wired \$59.95

**DELUXE RF SIGNAL GENERATOR #315**

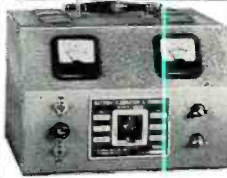

Sep. volt-meter & ammeter  
**KIT \$29.95**  
Wired \$38.95

**6V & 12V BATTERY ELIMINATOR & CHARGER #1050**



Sep. hi-gain RF & lo-gain audio inputs. Special noise locator. Calibrated wattmeter.  
**KIT \$24.95**  
Wired \$39.95

**DELUXE MULTI-SIGNAL TRACER #147**



Reads 0.5 ohms -500 megs, 10 mmfd-5000 mfd power factor.  
**KIT \$19.95**  
Wired \$29.95

**R-C BRIDGE & R-C-L COMPARATOR #950B**

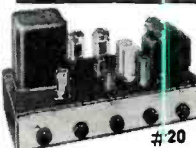

**NEW! High Fidelity Amplifier #20**  
**KIT \$49.95**  
Wired \$79.95

20-20,000 cps  $\pm$  0.5db IM distortion 1.3%. Harmonic distortion 0.3%. All at 20 watts. Ultra Linear Williamson, 5 pos. equal., tone & loudness controls.



**20,000 Ohms/Volt MULTIMETER #565**  
**KIT \$24.95**  
Wired \$29.95

**1000 Ohms/Volt MULTIMETER #536**  
**KIT \$12.90**  
Wired \$14.90

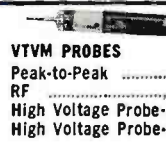

**VTVM PROBES**  
Peak-to-Peak ..... \$4.95 \$6.95  
RF ..... \$3.75 \$4.95  
High Voltage Probe-1 ..... \$6.95  
High Voltage Probe-2 ..... \$4.95

**SCOPE PROBES**  
Demodulator ..... \$3.75 \$5.75  
Direct ..... \$2.75 \$3.95  
Low Capacity ..... \$3.75 \$5.75

For FREE 1956 catalog, mail coupon NOW!



84 Withers St. • Brooklyn 11, N. Y.

Prices 5% higher on West coast and subject to change without notice. ©55

EICO, 84 Withers Street R-1  
Brooklyn 11, New York

Send FREE 1956 Catalog and name of neighborhood EICO jobber.

Name.....

Home Address.....

City.....Zone.....State.....

Occupation.....

1945 to 1955: a decade of Know-How & Value Leadership in Kits & Instruments—over 1/2 million sold to date!



# Choosing

## A PHONO PICKUP

By

N. H. CROWHURST

A PERFECT pickup has not yet been designed and is not likely to be. So the best we can do is to find the nearest thing to perfection among the different varieties of cartridge available. Because none of them is perfect, the decision as to which one comes closest to perfection is a matter of personal choice. As in many other fields of endeavor, one school of thought claims the correct way of doing it and thinks any other way is incorrect. The fact sometimes remains that the man who adopts a method dubbed as "incorrect" often achieves results quite as good as, and sometimes better, than the man who adopts the supposedly "correct" method.

The whole field of audio has its own special jargon, but probably no part of the field has a greater concentration of specialized terms than the beginner encounters when he sets out to acquire a high-fidelity phonograph reproducing system. The only way to decide for yourself is to be well armed with a knowledge of the significance of the different technical terms involved, so as to know what to look for and listen for in each particular type of instrument.

### Transducer Element

Let's start by considering the different methods by which the mechanical movement, picked up by the stylus, is transformed into electrical energy to be amplified by the system. This is chosen first because it is a very important point in achieving freedom from distortion. Also there are quite a number of names here, some of which have overlapping significance, so the newcomer can be confused as to just which type is which.

The method that has been in use the longest is called, variously, moving iron, magnetic, or variable reluctance. The term "moving iron" derives from the days of radio when there were just two kinds of loudspeaker. The older variety used a fixed coil with an iron armature that moved when signal currents were fed through the coil. The improved type of that day had the whole magnetic structure fixed and the coil was allowed to move with the



*A detailed description of the operating principles of most of the major types of pickups with specific suggestions for picking a unit for your audio system.*

audio signal currents in it. These types were designated respectively moving iron and moving coil. The same principle is applied to pickups where, in reverse, the movement causes the electrical currents instead of *vice versa*.

The term "moving iron" signifies that there is a moving armature with a fixed coil and that movement of the armature in some way varies the magnetic field passing through the fixed coil.

This construction is also called magnetic because the movement of the needle or stylus causes changes in the magnetic field which, in turn, generates an electrical output.

It is also called variable reluctance because reluctance is the quantity which causes the magnetic field to change. "Reluctance" is a term in magnetism similar to resistance in electricity. By changing the length of air gap in different alternate magnetic paths from the magnetic pole pieces, the reluctance of those paths changes and hence the magnetic field or flux changes its course. Fig. 1 illustrates the basic structure of a pickup of this type.

The next group comes under the general heading of dynamic. This is really an abbreviation for the full term electrodynamic which means that the audio output generated derives from movement of the electrical "conductor"

in some way. In this group are two sub-groups, moving coil and ribbon, each of which employ the same basic principle. The chief difference lies in the fact that a coil contains a number of turns wound into a solid form, while a ribbon is a single half turn of flexible conductor that is free to move in the magnetic field.

In a pickup the moving coil or ribbon has to be extremely small in order to maintain good frequency response out to the high frequencies.

There are two basic ways in which the moving coil can move. These are illustrated in Fig. 2. In Fig. 2A the coil is rotated in the magnetic field in such

**Fig. 1. Basic principle of moving iron, magnetic, or variable reluctance type pickup. At (A) the armature in its central position does not carry any magnetic field in the coil. At (B) some of the magnetic field, shown dotted, passes through the coil, because the armature is displaced. (C) Displacement in the opposite direction reverses the direction of field through coil.**

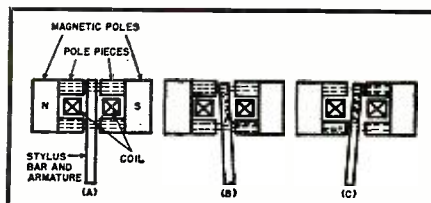



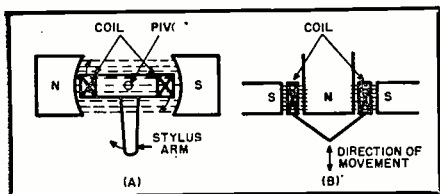

Fig. 2. Basic principles of moving coil pickups. At (A) the coil rocks about an axis due to the movement of the stylus. At (B) the whole coil moves as indicated.

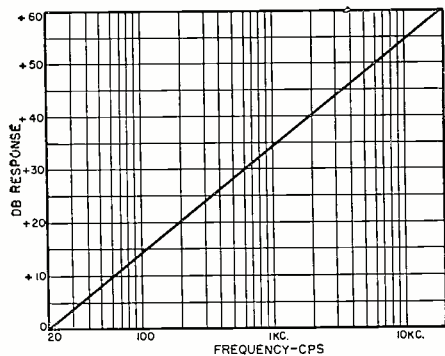

Fig. 3. Relation between constant-velocity and constant-amplitude characteristics. If a variable-frequency disc were recorded at constant amplitude and played back with a velocity-sensitive pickup, the response would follow the curve indicated above.

a way that the voltages developed in it, due to its rotation, are additive in the opposite sides of the coil. In the arrangement of Fig. 2B the coil follows a push-pull movement and in this case the whole of the coil is active in producing voltage because the whole of the coil is between a north and south pole. The latter construction is basically similar to that of a moving coil speaker except, of course, that it is very much smaller.

All the types so far mentioned use electromagnetic principles for transforming the mechanical movement into an electrical output. The difference lies in that the first type produces the electrical output by changing the configuration of the magnetic field, while the second (dynamic) type keeps the magnetic field constant—and it should be uniform throughout the area in which the coil moves—and produces the electrical output by moving the coil (or electrical conductor in the case of the ribbon) in the uniform magnetic field.

This is where our theorists would have us believe there is a right and wrong type. According to theory it is impossible to obtain a perfectly uniform change in the configuration of the magnetic field with the movement of the armature. Early studies of magnetism show that the attraction between poles of opposite kind is proportional (a) to the strengths of the poles and (b) inversely to the square of the distance between them.

If we consider the construction shown in Fig. 1, statement (b) means that in a condition of balance, where the distances are equal, as shown, all the magnetic pulls are uniform; but as soon as the armature gets a little off-balance it will tend to pull to one side

or the other according to the direction of movement. This is overcome in practice by use of a centering force, which also often serves as damping, enabling the armature to be restored to its central position. Careful attention to the design of the magnetic field construction can also produce a magnetic centering force.

But whatever construction is used, it is theoretically impossible to obtain an electrical output that faithfully follows the mechanical input, because of the inherently nonlinear manner in which the magnetic field changes with movement of the armature. In practice, the fact that the phonograph needle or stylus moves such very small distances, in the course of playing a phonograph record, means that the effective linearity has to be maintained over a very small movement, and not over the entire distance through which the stylus could move before hitting both pole pieces. This fact means that, by very careful design, a close approximation to linearity can be achieved over the small amount of actual movement encountered in playing phonograph discs.

The protagonists of the dynamic, that is, the moving coil or ribbon type, phono pickup tell us that it is inherently linear, because, if the coil moves in a uniform magnetic field the output will always be proportional to the mechanical movement causing it no matter how far the stylus moves.

In practice there are many other things that enter into the design of a phono cartridge, which means that it is not an essential fact that a moving coil or ribbon cartridge is free from distortion, while a moving iron cartridge must have distortion. The electromechanical transducer effect is not the only thing that can cause distortion. The mechanical suspension arrangement, responsible for controlling the movement, can also cause distortion in the way the stylus moves, or follows the groove. This fact can mean that a moving coil may not give any better performance than a well-designed pickup of the magnetic or moving iron variety.

All of the pickups thus far discussed require some kind of damping or controlling element to center the movement of the mechanism. For satisfactory performance of the unit, this material has to possess both a stiffness, or compliance, and a resistance to movement, or damping. Various kinds of rubber and plastic materials are employed for this purpose.

At different times in the history of phonograph development, individual pickups have been built, which at the time possessed perfect damping. The big problem is that none of these damping materials so far produced will last indefinitely. Their qualities deteriorate with time, and hence the performance of the pickup will not maintain its "new" standard. Improved materials have been developed which considerably lengthen the time for which the pickup will give its "new"

performance, but to date no material has been developed which will last indefinitely.

This means that any pickup in either of these classes has a limited life before the damping material must be renewed, if original performance is to be maintained. In practice, of course, the adoption of the plug-in cartridge idea has enabled the user to remove the old cartridge and plug in a new one of identical type, when performance begins to deteriorate.

Another feature that all the pickups discussed so far possess in common, is the use of the velocity principle. This means that the electrical output from the cartridge is dependent upon the velocity at which the stylus tip moves. Technically this means that the peak of an audio waveform occurs when the stylus tip is moving at its maximum velocity which will be the middle position of a fluctuation in the groove. When the stylus is not moving the output is zero momentarily.

This would appear to be just a matter of phase relation and, as such, would be comparatively unimportant, but there is another fact that derives from it. If we consider a theoretical disc on which a groove of varying frequency has been cut, and the amplitude of movement of the groove is the same at all frequencies, then obviously the stylus will have to move very much faster at the high frequencies to reach this amplitude than it does at the low frequencies. In fact, the velocity of movement, for constant amplitude, will be proportional to frequency. Since the output from this type of cartridge is proportional to velocity, this means that a constant-amplitude recording will produce an output rising at 6 db-per-octave, in order to be proportional to frequency, as shown in Fig. 3.

In practice, most of the cutter heads used for making recordings also employ the constant-velocity principle so that the recordings would be of constant velocity with frequency rather than constant amplitude, if it were not for the equalization employed, both in recording and playing back. If a completely constant-velocity principle were used in making recordings, the width of groove modulation would increase at low frequencies, inversely proportional to frequency.

Because this would result in prohibitive groove excursion, wasting record space at the low frequencies, the response is rolled off as part of the equalization characteristic on recording, and a corresponding low-frequency boost is introduced in the playback amplifier, following the pickup.

Similarly, because the very small excursion that results at high frequencies will not be much bigger than the little bits of dust that collect in the groove and cause noise, the high frequencies are pre-emphasized, so as to be of larger amplitude, before recording, and the playback equalizer introduces a high-frequency roll-off to bring these upper frequencies back to their correct normal relationship.



This means that, on the basis of our theoretical constant velocity recording, the record characteristic is as shown in Fig. 4A while the playback characteristic is complementary to it as shown in Fig. 4B. In practice there is a variety of equalization characteristics and those shown here are just typical of the general scheme.

There are other types of recording heads and pickups that employ a constant-amplitude principle, that is, the output is proportional at all frequencies to the *amplitude* of stylus movement. In Fig. 4B the result of playing a constant-velocity type disc through a constant-amplitude type pickup is shown dotted. It will be seen that not too much equalization will be necessary to bring this to a level response, because the equalization required will be the difference between the solid curve and the dotted line. This equalization is shown at Fig. 4C.

Popular types of pickups, using the amplitude principle, are the piezoelectric and the electrostatic. The piezoelectric types fall into two groups, the crystal and ceramic. Both employ a piezoelectric principle in which movement of the stylus sets up a voltage due to distortion of the piezoelectric material.

In the crystal type of cartridge the piezoelectric material is a Rochelle salt crystal. These were very popular in the thirties and gave reproduction that was quite pleasing compared with the best competitive forms at that time. However a crystal structure is always apt to have mechanical resonances of rather high "Q", which means that any peaks or valleys the mechanical system of the pickup introduces are apt to be rather severe.

They can be damped out to some extent but this is rather difficult. In modern design the construction of the pickup is such as to remove these resonances beyond the audio range.

The crystal type of cartridge has the disadvantage that Rochelle salt is extremely susceptible to high temperatures and moisture. Consequently they can easily deteriorate, if subjected to high temperatures or humid conditions. The ceramic type of cartridge employs a variety of ceramic in which the molecules have been polarized during manufacture under a strong electrostatic field. This produces a piezoelectric material which is not subject to temperature and humidity in the same way that Rochelle salt is.

With this basic type of element there is a limit to the amount the crystal or ceramic element can be distorted before its elastic limit is reached. Beyond this limit, further stress permanently distorts the element, until a stress in the opposite direction restores it to its original form. So, as the elastic limit of the material is approached, the relation between movement of the stylus and electrical output will cease to be linear and it will begin to introduce distortion.

The final choice of pickup cartridge

to be discussed is the electrostatic type. It does not employ the simple electrostatic principle of producing a voltage by varying the capacitance of the plates with a constant charge. In this cartridge the capacitance between the plates, which the movement of the stylus varies, is part of an oscillatory circuit, operating as an r.f. generator. Variation of the stylus position modulates the frequency of r.f. oscillation, which is then demodulated, in the same way an FM receiver demodulates an FM carrier, and the output is available as an audio signal. This is the principle used in the *Weathers* cartridge.

While this technique very conveniently eliminates many of our mechanical problems, at the same time it really transfers them into the electrical circuit, because now our linearity is determined by the correct operation of the FM demodulator circuit.

### Type of Stylus

So much for general transducer principles. Before we discuss the various characteristics of these pickups in general there are some features related to the contact between disc and stylus that require attention. One question that will arise concerns what stylus point to use.

In the early days of phonograph pickups, steel needles were used and the record manufacturers introduced abrasive material into their discs, which served the purpose of keeping the steel needle sharpened to the correct shape during the playing of one disc. The single-play type needles wore down sufficiently during this playing to make them unsuitable for a second playing and so the needle had to be changed after every disc. Failure to do this resulted in serious damage to the record due to the needle becoming unduly enlarged at its point.

The use of successively harder grades of steel resulted in needles that would play for a longer time before needing to be changed. First, needles were developed that would last ten playings and then the so-called "permanent" type, which was sold in packets of ten instead of boxes of a hundred. Of course the fact that you bought ten in a packet belied the title "permanent."

These facts serve to illustrate a basic principle in the use of phonograph discs for transcription of program material. The recorded information has to be transferred from the disc groove to a stylus by mechanical friction between the groove of the disc and the point of the stylus. This inevitably involves wear. The early attempt was to make the needle suffer more than the record so as to preserve the quality of the record longer. However the wear was always considerable, because the needle was harder than the record material and hence both had to wear to some extent.

The high frequencies invariably suffer more than the lower frequencies in the course of wear because they constitute much smaller deviations in the

modulation of the groove. So the modern approach has been to reduce wear by reducing stylus pressure and using much harder stylus materials so as to minimize wear of both the disc and the stylus. Of course the degree of wear is still relative, because the mere fact that there is mechanical friction means that *some* wear must take place.

The successive development of sapphire and diamond styli has shown considerable improvement over the best hardened steel variety. The sapphire stylus will play much longer than the "permanent" needles just referred to, and the diamond stylus can be played over a thousand times without showing detectable wear.

Because the styli are so hard any wear that takes place will occur in the disc. This, of course, is distributed over miles of groove, and hence can be quite small, if the pressure between the stylus and the groove is kept to a minimum.

### Stylus Force

This pressure is called stylus force and a feature in the design of all pickups is the stylus force necessary to maintain tracking. The word "tracking" is applied to two different things in phonograph reproduction. The meaning intended here concerns the ability of the stylus to stay in the groove at all the modulation frequencies in the audio band. The other meaning has to do with correct tone arm mounting,

(Continued on page 147)

Fig. 4. Equalization characteristics associated with disc recording and playback. (A) Recording equalization for velocity-sensitive cutter head. (B) Playback (solid line) equalization for use with velocity-sensitive pickup and discs cut to the characteristic of (A). The dotted line is for a disc recorded at constant amplitude which would require this equalization for playback with velocity-sensitive pickup. (C) Playback equalization required for standard discs used with amplitude-sensitive pickup. This curve is the difference between solid and dotted lines of (B).

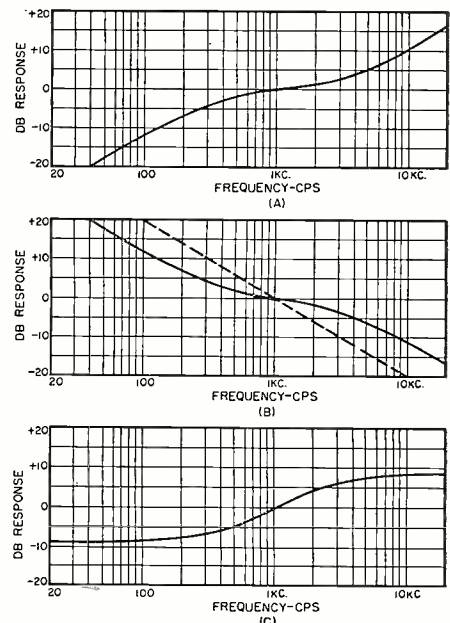





# Transistor

# Radios

Part 1. For the first time, here is a complete analysis of the operation of all transistor radios now available.

By MILTON S. KIVER \*

**A**MONG the first commercial equipment in which transistors are used are small, portable, radio broadcast receivers. This is a natural application since transistors lend themselves readily to compact, lightweight assemblies of the type required in such receivers. The portability feature is further enhanced by the fact that only small "B" batteries are required for power. Filament heating batteries, which vacuum tubes require and which occupy considerable space, are completely dispensed with here.

A number of manufacturers are now marketing transistor receivers (see above) and, in time, some of these units will be finding their way to the local service shop. As a first step in dealing with these sets, it behooves the technician to understand the basic operation of transistors in general. This material has already been covered in various articles in RADIO & TELEVISION NEWS and will not be repeated here. The next step is to consider transistor applications in various circuits, particularly those found in radio receivers, and that is the purpose of this article. We will see just what differences exist between vacuum-tube and transistor radios and, in most cases, why these differences arose. Once these are understood, then the technician will be able to apply specific servicing techniques intelligently and effectively.

### The Regency Radio

The first transistorized portable radio receiver to appear commercially was the *Regency* Model TR-1, which took advantage of every space-saving feature afforded by transistors and associated miniature components. See Fig. 1. Over-all dimensions of the unit are 5 by 3 by 1 1/4 inches, enabling the

entire set to fit easily into the pocket of a man's shirt. Weight of the set, with the batteries, is about 12 ounces.

The schematic diagram of this receiver is shown in Fig. 3. There are four transistors and five stages; the extra stage is the second detector and its function is performed by a germanium diode, here either a *Raytheon* CK706A or a *Tung-Sol* TS117. The transistors are of the *n-p-n*, germanium, grown-junction variety and three different types are used for the converter, i.f., and audio stages. All are made by *Texas Instruments, Inc.*

The first stage, containing transistor  $V_1$ , is essentially a self-oscillating converter. The input signal is picked up by a tuned ferrite-core coil which possesses a high "Q." A low-impedance winding on the antenna coil couples the signal to the base of  $V_1$ . Local oscillations are generated by a parallel resonant circuit connected to the emitter. The former is inductively coupled to a coil in the collector circuit. The low impedance emitter is tapped down on the tuned circuit in order to provide the proper impedance match without lowering the "Q" of the circuit.

The foregoing oscillator arrangement is a fairly common one. Its equivalent vacuum-tube circuit is shown in Fig. 2. With the incoming signal and the local oscillator voltage both being applied to the converter transistor, the appropriate i.f. signal is formed and then fed to  $T_1$ .

A 10,000-ohm resistor is placed in the emitter circuit to provide d.c. stabilization against temperature changes and variations among different replacement transistors. The positive voltage which the emitter current de-

velops across  $R_2$  is counterbalanced by a positive voltage fed to the base from the battery. The actual voltage difference between these two elements is only on the order of .1 volt or so. The proper biasing voltage for the collector of  $V_1$  is obtained from a 2200 ohm resistor which is tied to the 22 1/2-volt "B+" line. A .001  $\mu$ fd. bypass capacitor,  $C_7$ , keeps the signal currents out of the d.c. distribution system.

There are two stages in the i.f. system and both operate at 262 kc. This frequency is considerably below the 455 kc. common in vacuum-tube radio receivers and it possesses the disadvantage of making the receiver more susceptible to image frequency pickup. However, the lowered frequency of operation is advantageous in that it provides greater gain and more stability.

The primary of each i.f. transformer is tuned with a fixed capacitor while the secondary is untuned. This is done to match the high collector impedance of the preceding stage to the low input impedance of the following stage. Peaking of each i.f. coil is achieved by varying the position of its slug.

Each i.f. stage is neutralized by feeding back a voltage from the base of the following stage to the base of the preceding stage. The feedback occurs through a 560-ohm resistor and a 100 to 200  $\mu$ fd. series capacitor. The capacitor value is not specifically indicated because its exact value will depend upon the internal capacitance of the transistor and this will vary from unit to unit. Actually, what happens in this particular receiver is that whenever a replacement i.f. transistor is ordered from the set manufacturer, a suitable neutralizing capacitor is sent along, too, and both components must be replaced. Whether or not an i.f. stage will require neutralization de-

\* Author of "AM-FM Servicing Short Cuts," *Howard W. Sams & Co., "TV and FM Receiver Servicing," D. Van Nostrand Co., and other books.*



depends upon the collector-to-base capacitance of the transistor being used. In high-frequency transistors, this internal capacitance may be small enough so that the neutralization may not be needed, especially at the lower r.f. or i.f. frequencies. This is true in a receiver to be described presently. However, where this capacitance is large enough to cause noticeable feedback, neutralization, as shown in Fig. 3, must be used.

The a.g.c. is applied to the first i.f. stage only. A negative voltage is obtained from the second detector and applied to the base of  $V_2$ . Its purpose is to regulate the collector current and, with it, the stage gain. When the incoming signal becomes stronger, the negative a.g.c. voltage rises and this serves to reduce the collector current of  $V_2$  and, with it, the gain. The opposite condition prevails when the signal level decreases. This method is quite effective and provides a wide range of control. (A discussion of automatic gain control in transistor receivers will be given after this analysis of the *Regency* Model TR-1.)

The base bias for the second i.f. stage is obtained from the emitter of the audio output stage (which here operates class A). This bias voltage is heavily bypassed by  $C_{21}$  and then further bypassed by  $C_{15}$ , a .05  $\mu$ fd. capacitor.

Both i.f. stages are connected as grounded-emitter amplifiers. Furthermore, both emitters have d.c. stabilizing resistors. (If it were not for the presence of  $C_8$ ,  $C_{13}$ ,  $C_{13}$ , and  $C_{15}$ , signal degeneration would occur, also. As it is, only the d.c. portion of the current passes through  $R_5$  and  $R_8$ .) Note, however, that the emitter resistor of the first i.f. stage is only 560 ohms in value whereas the emitter resistor of the second stage is 2700 ohms. The reason for this difference stems from the compromise that must be reached in the first i.f. stage between good a.g.c. action and the d.c. stability of the amplifier. A value of  $R_5$  greater than 560 ohms (note the emitter resistor of the next i.f. stage) is desirable for stability

purposes, but the degeneration that produces the stability would result in reduced gain control action.

The collectors of  $V_2$  and  $V_3$ , each receive their operating voltages through 2200-ohm dropping resistors.  $C_{11}$  and  $C_{15}$ , at the top end of the resistors, serve as decoupling and bypass capacitors.

Following the 2nd i.f. stage is the second detector and this function is performed by a germanium diode. The load resistor for the detector is the volume control. Note the low impedance of the control, 1000 ohms; this low value is needed to match the input impedance of the audio output stage,  $V_4$ .

The final amplifier is operated with the emitter grounded through a 1000-ohm resistor. Base bias is obtained from the voltage divider network formed by  $R_{13}$  and  $R_{11}$ . The output transformer matches the 10,000-ohm collector impedance of  $V_4$  to the low voice coil impedance of the miniature speaker. Diameter of the speaker is only 2 1/4 inches. Provision also exists for a small earphone plug which can be inserted into a small jack,  $J_1$ , on the side of the receiver. When the earphone is in use, the speaker is disconnected.

The total power for the receiver is furnished by a hearing-aid type of 22 1/2-volt battery. Total current drain is on the order of 4 milliamperes.

The compactness of this receiver can be seen by an inspection of Fig. 1. All components, including the two-gang tuning capacitor and the speaker, are miniaturized. The operating voltage of electrolytic capacitors  $C_9$ ,  $C_{21}$ , and  $C_{16}$  is 3 volts; of  $C_{17}$ , it is 25 volts.

### Automatic Gain Control

The two most effective methods of controlling the gain of a transistor amplifier are to vary either the emitter current or the collector voltage. Fig. 4 illustrates the variation in gain that can be achieved by varying emitter current ( $I_e$ ) or collector voltage ( $V_c$ ).<sup>1</sup> Now, to provide this control, a certain

<sup>1</sup> "Automatic Gain Control of Transistor Amplifiers," by Chow and Stern, IRE Transactions on Broadcast and Television Receivers, Vol. BTR-1, No. 2, April, 1955.

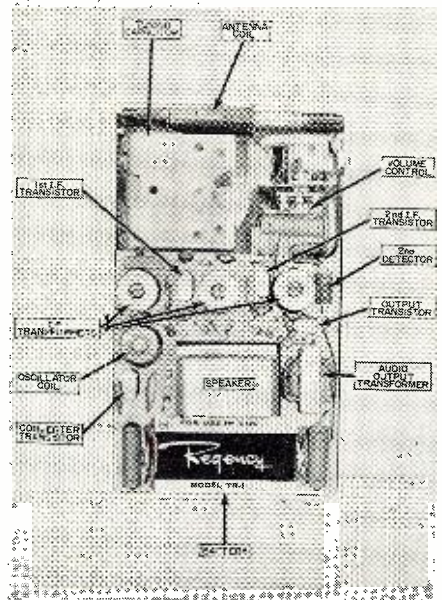

Fig. 1. Internal view of the Regency transistor radio Model TR-1 showing the location of the various components on the printed wiring board. Only the rear of the speaker magnet is shown.

amount of d.c. power is necessary. This arises from the fact that to vary  $I_e$  or  $V_c$  requires current from the control source. In vacuum-tube amplifiers, little or no power is required because the control voltage is fed to the grid of a tube and this element draws no current since it is negative with respect to the cathode. A transistor, on the other

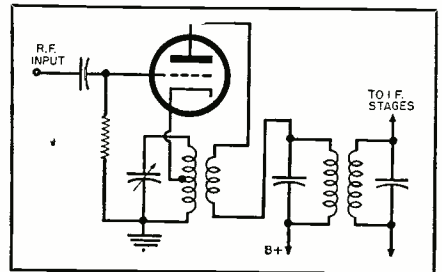

Fig. 2. The converter stage shown here is the equivalent vacuum-tube circuit of the transistor converter in Fig. 3.

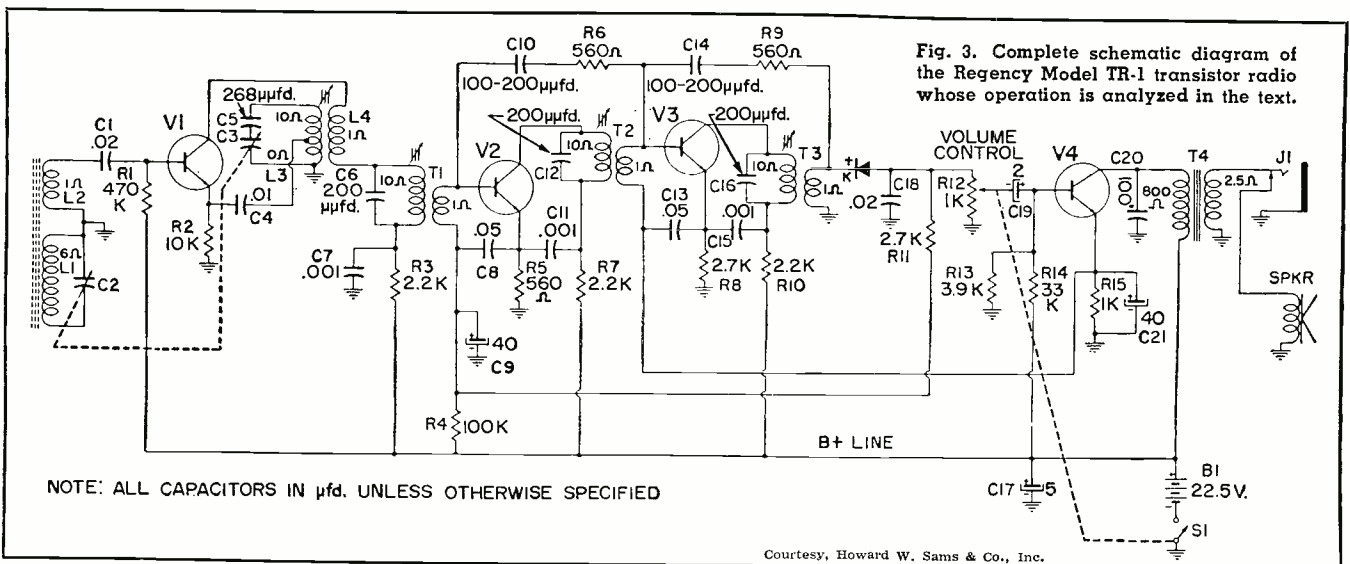

Fig. 3. Complete schematic diagram of the Regency Model TR-1 transistor radio whose operation is analyzed in the text.

Courtesy, Howard W. Sams & Co., Inc.



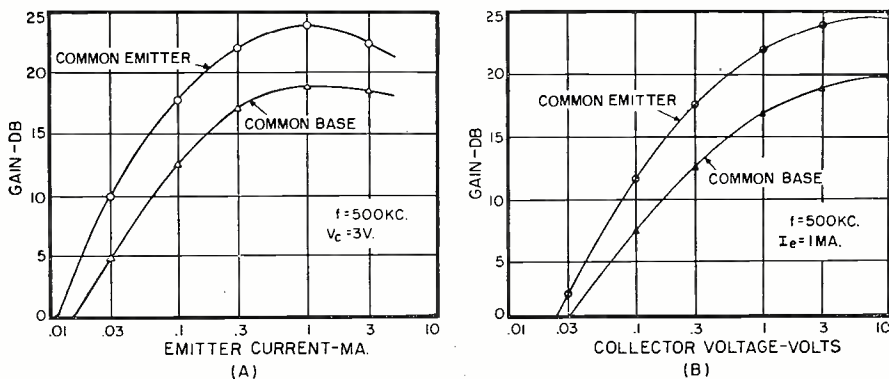

Fig. 4. Shown here is the way in which the gain of common emitter and common base transistor amplifiers vary with emitter current (A), and collector voltage (B).

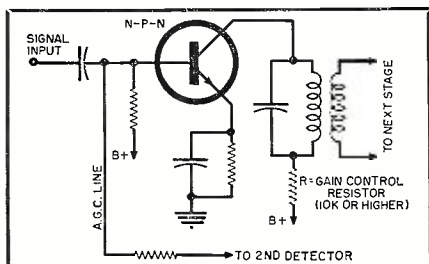

Fig. 5. Typical "n-p-n" transistor amplifier circuit with a.g.c. With resistor R in the circuit, collector voltage control is used; for emitter current a.g.c. a small resistor or no resistor is used with the collector.

hand, is a current-operated device and to alter its current, the control stage must supply a suitable amount of its own current. This, in turn, means that power must be expended.

The control voltage is almost invariably obtained from the second detector and so it is this stage which must supply the control power. To assist the detector in this respect, the controlled transistor i.f. amplifier is also made to function as a d.c. amplifier for the control signal. For example, in the stage shown in Fig. 5 (without resistor R), the emitter current is a.g.c. controlled. However, instead of varying the emitter current directly, the control voltage is applied to the base of the transistor and the resulting changes of d.c. base current are amplified and appear as larger changes of emitter current and

gain. When the incoming signal is strong, then a voltage is fed back which serves to reduce the emitter current and the stage gain is reduced. (By reducing the emitter current, we also reduce the collector current and hence the strength of the signal developed across the output tuned circuit.) Conversely, when the incoming signal is weak, the voltage fed back is reduced in value, permitting more emitter current to flow and raising the gain.

If sufficient power is available in the detector circuit, an attempt can be made to control the emitter current directly by introducing the control voltage in the emitter circuit of the i.f. stage. However, in the absence of this power, the control voltage can be applied to the base of the i.f. stage, as shown.

The graph of Fig. 4B demonstrates that the gain of a transistor may be varied by changing the collector voltage. A circuit designed to achieve this is shown in Fig. 5 (with resistor R in the circuit). Note the presence of the resistor in the collector lead. The control voltage is again applied to the base and variations in base current appear as amplified variations of emitter and collector current. The resulting change in voltage across the resistor in the collector circuit also leads to changes in collector voltage and gain.

In order to effect control by this method, then, a resistor is needed in the collector circuit. There is, however, an even more significant difference between this system and the prior one.

Fig. 6. Schematic diagram of a two stage transistor i.f. amplifier followed by a transistor detector. Collector voltage ( $V_c$ ) type a.g.c. is employed in this case.

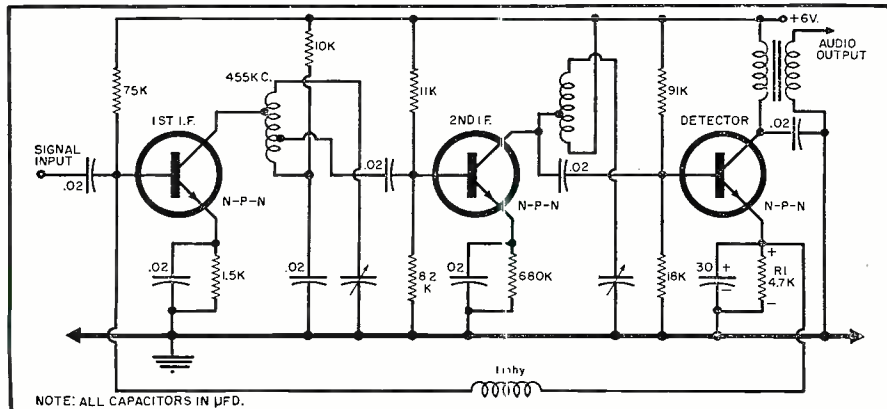

This concerns the polarity of the control voltage applied to the base of the controlled i.f. amplifier. In the previous method, the a.g.c. voltage served to reduce base and emitter currents when the incoming signal increased in amplitude. In the  $V_c$  control method, we follow the reverse practice. Now, the a.g.c. voltage is made to increase base and emitter (and collector) currents with increasing signal strength. This causes the voltage drop across the collector resistor to rise, reducing  $V_c$  and with it, the gain of the stage.

The object, in this method, is to control transistor gain by varying the collector voltage. To reduce the gain, we must reduce the collector voltage; on the other hand, to increase the gain, we raise the collector voltage. To achieve effective control, the collector resistor should have a value in the vicinity of 10,000 ohms or more. Too small a resistance value will not provide the desired range of control, while too high a resistance will lead to premature cut-off and distortion.

The best guide for the service technician to follow in attempting to identify the system of control is to determine what happens to the emitter current as the signal level rises. If the control voltage increases the emitter current with increasing signal level, then  $V_c$  control is being employed. Under these circumstances, a collector resistor will be found. But if the control voltage depresses the emitter current with signal level increase, then  $I_e$  control is being employed. A collector resistor may or may not be used, but if it is, then its value is usually under 10,000 ohms.

In the receiver whose schematic is shown in Fig. 3,  $I_e$  control is employed; i.e., the a.g.c. voltage becomes increasingly negative with rising signal and this voltage, fed to the base of an n-p-n transistor, reduces the emitter current. The 2200-ohm collector resistor is low enough in value not to seriously affect collector current or transistor gain.

An i.f. system employing  $V_c$  control is shown in Fig. 6. Here, n-p-n transistors are employed in the two i.f. stages as well as in the detector. The detector, which we shall discuss next month in greater detail, is operated essentially in class B, so that it is biased close to cut-off.

The voltage drop across  $R_c$  is such that the top end is positive with respect to the bottom end. When the average level of the signal rises, the voltage across  $R_c$  increases also. This voltage, which is well filtered by a 30- $\mu\text{fd.}$  capacitor so that the only variations are those due to slow changes in signal level, is fed back through a 1 millihenry choke to the base of the 1st i.f. amplifier. Since the transistor here is of the n-p-n variety, a positive rise in voltage will cause the base, emitter, and collector currents to rise. This, in turn, will increase the voltage drop across the 10,000-ohm collector resistor and reduce the collector voltage. The second i.f. stage is not controlled.

(To be continued)



Fig. 1. Front view of instrument.

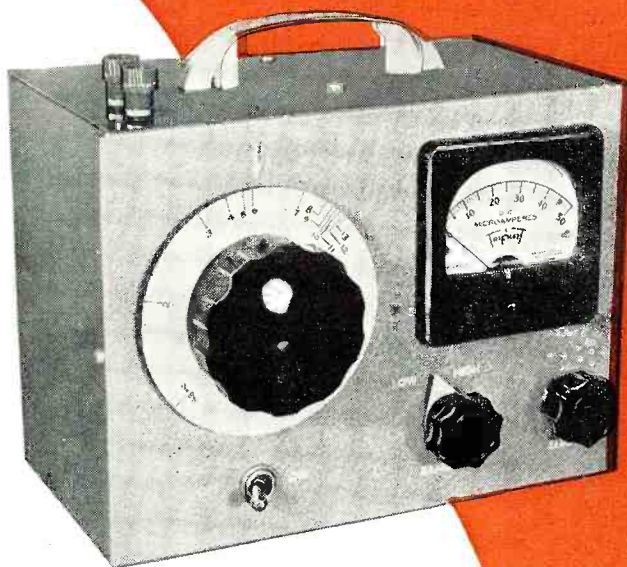

By RUFUS P. TURNER, K6AI

IMMEDIATELY after the commercial introduction of the germanium diode eight years ago, radio amateurs quickly recognized the usefulness of this component as a reliable detector in simple field strength meters. Aside from the diode, all that is required besides a pickup antenna is a coil-capacitor tuned circuit and a 0-1 d.c. milliammeter. The obvious advantages are: no power supply, no tubes, instantaneous operation, light weight, small size, and simple tuning. Many a TV technician in the interim has been exasperated that the same simple arrangement would not perform as well with a TV antenna, either for antenna positioning or field strength measurements. Doubly vexing was the fact that replacing the milliammeter with a more sensitive d.c. microammeter failed to boost the sensitivity enough to make conversation.

The transistor offered new hope. While conventional transistors will not operate at TV frequencies, it was felt that a transistor amplifier might be used to raise the feeble output of a diode detector sufficiently to drive a meter.

The author carried on developmental work along two lines in this direction. The first approach was to amplify the video buzz, coming from the diode, with a high-gain transistor audio amplifier, then to rectify the amplified signal and use the resulting d.c. to drive a milliammeter. This scheme proved unsatisfactory. First, the video signal seldom is constant unless a test pattern is being transmitted, and this causes the meter deflection to waver endlessly. Second, the problem of matching the low-impedance rectifier-meter circuit to the high output impedance of the transistor amplifier proved as much of a sticker as the original problem.

Fig. 2. The transistorized d.c. amplifier is mounted on the transparent polystyrene plate secured to back of the microammeter. Tuner is on shelf-plate to the right.

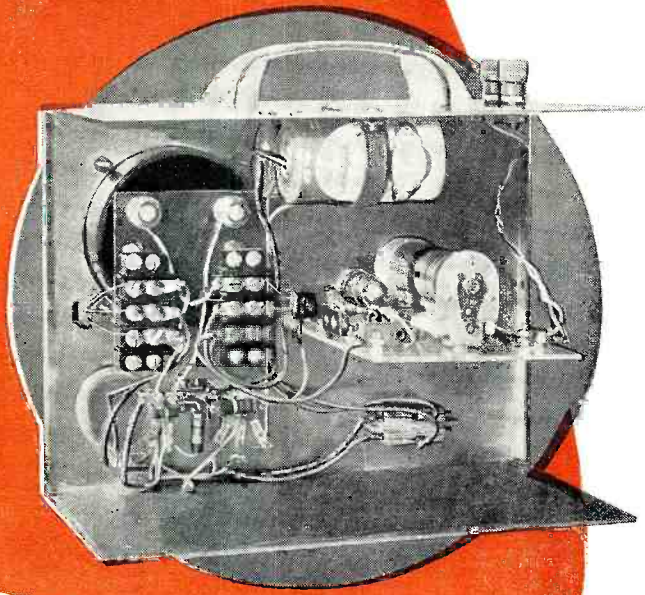

*Complete details on a lightweight, low-current unit which has an r.f. sensitivity of 10 mv. full scale.*

The second approach was use of a high-gain transistor d.c. amplifier to boost the d.c. output of the diode sufficiently to deflect the meter. This method proved superior, since the d.c. component is proportional to the average carrier, and substantial direct-current amplification is obtainable in fewer transistor stages, minus interstage impedance matching difficulties, than in transistorized a.c. amplifiers. The entire transistor-and-meter circuit effectively becomes an ultra-sensitive d.c. microammeter operated from the output of the diode detector of the simple field strength meter.

The author previously described an amateur field strength meter of this type<sup>1</sup>, and transistorized sensitive d.c. microammeters have been described in the literature.<sup>2,3</sup> To adapt the transistorized amateur field strength meter to weak-signal TV service required only (1) provision for a tuned circuit for the TV frequencies, (2) substitution of a

microammeter for the usual milliammeter, and (3) use of a 2-stage common-emitter amplifier containing high-alpha transistors.

The final instrument, which is described in this article, has a maximum full-scale r.f. sensitivity of 10 millivolts r.m.s., it operates from two 1½-volt flashlight cells capable of supplying power *continuously* more than 1 month, is small in size (8"x6"x4½", and can be made smaller), tunes to channels 2 to 13 and through all of the territory between channels, and weighs only 3½ pounds. Its compactness and light weight enable it to be carried to roof tops with ease.

The tuning range of the instrument is 48 to 226 megacycles. This continuous tuning range includes FM broadcast frequencies and the amateur 2- and 6-meter bands, in addition to the TV channels. Its high sensitivity should make possible the adjustment of amateur antennas fed from a signal gen-



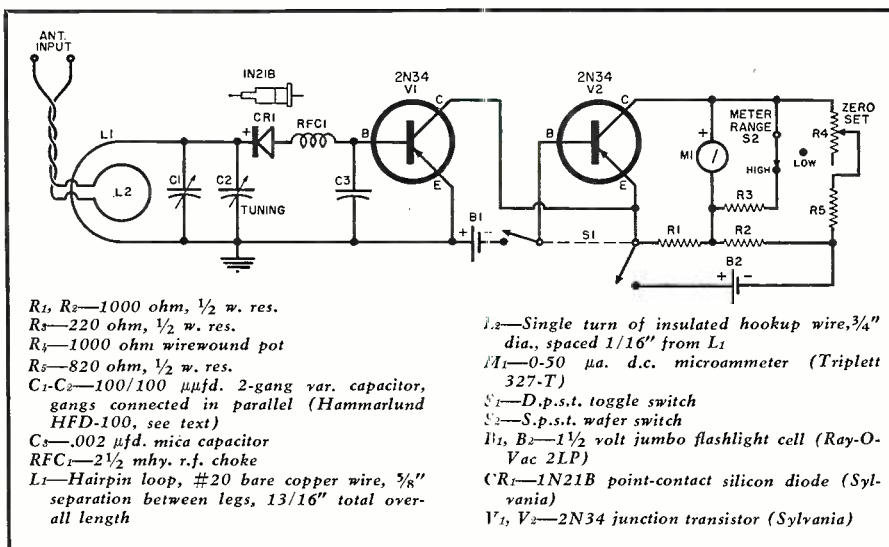

Fig. 3. Complete circuit of the transistorized TV field strength meter.

erator, instead of the transmitter, to reduce QRM. As a TVI locator and harmonic chaser, this instrument is a star performer.

### Instrument Circuit

The complete circuit is shown in Fig. 3. The arrangement is seen to consist of a single tuned circuit, silicon diode detector, 2-stage direct-coupled transistor amplifier, and d.c. microammeter circuit.

The tuner consists of a hairpin loop inductance ( $L_1$ ) and a 200- $\mu\mu\text{fd}$ . variable capacitor,  $C_1$ - $C_3$ . In order to prevent self-resonance within the tuning range, a frameless u.h.f.-type tuning capacitor is required. The most satisfactory units of this type were found to be the *Hammarlund* HF series. But since this type was not available in 200- $\mu\mu\text{fd}$ ., a dual 100- $\mu\mu\text{fd}$ . unit (HFD-100) has been used with its two sections connected in parallel. The antenna is coupled into the loop through a 3/4-inch-diameter, 1-turn coil,  $L_2$ , spaced 1/16 inch from  $L_1$ . The hairpin loop is made with No. 20 bare copper wire and is soldered directly to the tuning capacitor. The legs of the hairpin are separated by 3/8 inch; the over-all length of the hairpin is 13/16 inch.

The detector is a 1N21B point-contact silicon diode. This type is preferred to germanium diodes in this application because of its higher rectification efficiency (ratio of d.c. output voltage to peak applied r.f. voltage) at the higher television frequencies. The lowest r.f. input voltage which this diode will detect is around 1 millivolt r.m.s. The forward conduction curve of the crystal is quite flat at such low voltages, and at still lower potentials the rectification properties simply evaporate. However, this limiting value of approximately 1 millivolt appears to be a characteristic of all crystal diodes, silicon and germanium alike, although an occasional unit will rectify a 1/2-millivolt signal. Nevertheless, it is possible to "see" a 1-millivolt signal with this field strength meter, and since the FCC sets the fringe-area signal level at 500 microvolts (1/2 millivolt) per

meter, this response is not bad when the simplicity of the instrument is considered.

The d.c. amplification is provided by the two transistors,  $V_1$  and  $V_2$ , which are direct coupled. Each uses base input—emitter return for high current gain. The collector output current of the first transistor flows directly through the base-input circuit of the second transistor. Thus, the arrangement is a *current* amplifier in the strictest sense. It does not first convert current into voltage, as a tube-type amplifier does, and then amplify this voltage. The direct-coupled current scheme removes the necessity for "lossy" load resistors in coupling between stages. The over-all current gain of the 2-stage amplifier is better than 1000, which means that a diode d.c. output of less than 0.05 microampere will deflect the 0-50 d.c. microammeter to full scale.

The no-signal d.c. collector current ( $i_{co}$ ) of the first transistor flows into the second transistor and is amplified some 25 to 40 times by the latter to produce a no-signal deflection of the microammeter. The no-signal collector current of the second transistor also deflects the meter. However, the zero-set adjustment bucks out the effects of both  $i_{co}$  components. The no-signal currents are low in the 2N34 transistors, so the  $i_{co}$  of  $V_1$  does not drive  $V_2$  into its low-amplification region. Tests on a number of transistor pairs proved this to be true, and for this reason the complication of an additional zero-set circuit in the first transistor stage was abandoned.

The transistor type was chosen for low  $i_{co}$ , high current amplification factors (*alpha* and *beta*), low noise, and low drift. The *Sylvania* 2N34 gave the best performance without special picking of transistors. No temperature compensation has been included in the circuit. However, the amount of drift of the meter deflection, due to heating, observed in field tests appears adequately compensated by occasional re-adjustment of the zero-set potentiometer. This has not been found to affect the calibration. It is the author's feel-

ing that the re-adjustment is no more inconvenient than re-setting an ohmmeter before using.

The 0-50 d.c. microammeter,  $M_1$ , is connected in a 4-arm bridge circuit for zero setting. The bridge arms are  $R_1$ ,  $R_2$ ,  $R_4$ - $R_5$ , and the internal collector resistance of transistor  $V_2$ . This arrangement is similar to the bridge zero-balancing circuit employed in vacuum-tube voltmeters. The meter range switch,  $S_2$ , shunts the meter with a 220-ohm resistor,  $R_3$ , to multiply the meter deflection by approximately 10 for handling strong signals. Cutting this resistor into the circuit disturbs the zero setting of the meter by less than 1% of full scale (1 small scale division). When switch  $S_2$  is at its high-sensitivity (low-range) setting, any random fluctuation of the pointer due to transistor noise is less than one-quarter of a small scale division.

The battery drain is a matter of interest. With switch  $S_2$  in its "Low" position, battery  $B_1$  delivers 18 microamperes and  $B_2$  1.6 milliamperes when an input r.f. signal deflects meter  $M_1$  to full scale. With  $S_2$  in its "High" position,  $B_1$  delivers 30 microamperes and  $B_2$  2 milliamperes. These low current drains make operation from flashlight cells entirely feasible, since the familiar jumbo-sized cell is capable of better than 2000 milliampere-hours service on a 24-hour per day continuous basis.

As illustrated here, the field strength meter is built in an aluminum box 8" long, 6" high, and 4 1/2" deep (*LMB* No. 146). Figs. 1, 2, 5, and 6 show constructional details.

The tuner is built on a 3 1/2"x3 3/16" plate of 1/16" thick polystyrene. Fig. 5 shows details of the layout. In order to cover the tuning range and to avoid self-resonances, all leads within the tuner circuit must be kept as short as possible. The hairpin loop,  $L_1$ , is soldered directly to the front stator and rotor lugs of the tuning capacitor. The jumper between the two stator lugs is a short, *straight* piece of No. 20 wire. *Do not bend or loop this jumper*; keep it straight to minimize its inductance. The tip of the 1N21B diode is soldered directly to a stator lug of the tuning capacitor, to eliminate any lead length in this connection. To prevent heat injury to the crystal, hold its tip with long-nose pliers while making the soldered connection, and continue to hold it until completely cooled. A twisted-pair of insulated hookup wire is run between the lug terminals of coupling coil  $L_2$  and the two insulated antenna binding posts mounted on the left top of the case.

The transistor amplifier is built on a 4"x2 1/2" plate of 1/16"-thick polystyrene. This plate is held to the back of the microammeter by the meter screws, as shown in Fig. 6. On this plate are mounted the transistor sockets and resistors  $R_1$ ,  $R_2$ ,  $R_3$ , and  $R_5$ . Potentiometer  $R_4$  and switch  $S_2$  are mounted on the front panel of the instrument, as shown in Figs. 1 and 2. The transistor "sockets" are 3-terminal *Cinch-Jones* 3-140



barrier-type terminal strips. These screw strips offer the advantage of a solderless connection to the transistor leads, thereby removing all risk of heat-damaging the transistor. The transistors also can be removed easily from these connectors, if desired, for testing or for temporary use in other circuits. The author installed his transistors with their full pigtail lengths, as shown in Fig. 6. The pigtails then were bent slightly, as shown in Fig. 2, to position the transistors out of the way of other components.

The flashlight cells are fastened to the inside top of the case (See Fig. 2) by means of a strap made from discarded 300-ohm antenna ribbon. The carrying handle is a dime-store drawer-pull.

The 3-inch dial is a *National* Type O with a disc of white paper cemented over the regular metal dial plate and inscribed with the TV channel calibration.

### Calibration

The best frequency-calibrating source will be an accurate r.f. signal generator covering the range 48 to 230 megacycles, preferably on fundamentals all the way. This instrument should be a standard oscillator and *not* a sweep generator. The signal need not be modulated. The generator output is connected to the "Antenna Input" terminals of the field strength meter.

The author's dial, as seen in Fig. 1, is graduated in channels 2 to 13 (with the lowest-frequency point, 48 mc., marked) corresponding to the *video carriers* of these channels. It is important to note, however, that the instrument also peaks up at the sound carriers separately. Table 1 lists the video frequencies which must be obtained successively from the signal generator.

To make the frequency calibration: Set switch  $S_2$  to its "High" position. Throw switch  $S_1$  to "on." Zero the meter by means of potentiometer  $R_4$ . Set the signal generator as closely as possible to 55.25 mc., the channel 2

video carrier frequency. Tune  $C_1$ - $C_2$  for peak deflection of meter  $M_1$ . Reduce the setting of the signal generator attenuator if the meter is overdriven. Mark this point 2 on the dial. Repeat at each of the other frequencies in Table 1, marking the dial with the corresponding TV channel number. If the builder has followed the specifications of the tuner carefully, no trouble should be experienced in covering the range. Should there be trouble, squeeze the hairpin together to reach a higher frequency; spread it apart to reach lower frequencies. Before the dial is permanently inked-in, the calibration may be checked by tuning-in several TV stations and making any required correction.

An inspection of the dial graduations visible in Fig. 1 shows some crowding at the high-frequency end of the tuning range. This is to be expected with the straight-line capacitance type of tuning capacitor. Some improvement might be afforded by a straight-line frequency unit, although some crowding will always be present with a tuning range as great as this one. Nevertheless, it is surprisingly easy to tune the stations in and out with the field strength meter and to hold them on-the-nose once they have been tuned-in. The tuning arrangement employed in this instrument resulted from the author's desire to cover the entire frequency range in one rotation of the dial. However, an individual builder can, for improved selectivity and tuning, incorporate a switch- or push-button-type tuner.

If desired, the meter scale may be calibrated in millivolts or microvolts by comparison with a second, calibrated field strength meter operated in parallel with this instrument. However, it must be remembered that the crystal diode response at the low r.f. signal-voltage levels involved is approximately square-law, not linear like the microammeter scale. Thus, one-half the signal strength appears at one-quarter of full scale, 1/10 signal at 1/100 full

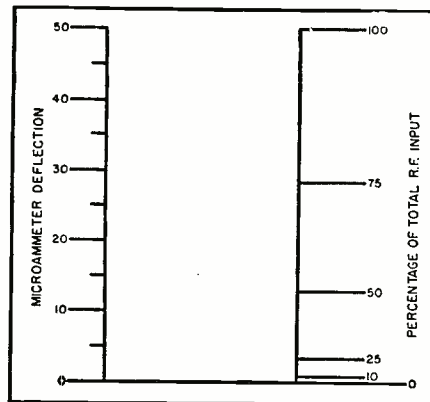

Fig. 4. Ideal square-law meter response.

TV CHANNEL	VIDEO CARRIER FREQUENCY (mc.)
2	55.25
3	61.25
4	67.25
5	77.25
6	83.25
7	175.25
8	181.25
9	187.25
10	193.25
11	199.25
12	205.25
13	211.25

Table 1. Video carrier frequencies corresponding to the TV broadcast channels.

scale, and so on. Fig. 4 gives a comparison between the microammeter scale and ideal square-law response. Another important fact is that the rectification efficiency of the crystal decreases as the frequency increases. The actual amount varies with individual diodes. This results in a somewhat lower meter deflection for a given r.f. input at high frequencies, and for highest accuracy would necessitate applying a correction factor.

### REFERENCES

1. Turner, Rufus, P.: "Transistors, Theory and Practice," Gernsback Publications, page 103.
2. Starke, Herbert F.: "The Transistor D.C. Amplifier," RADIO & TELEVISION NEWS, December, 1953.
3. Turner, Rufus, P.: "Transistorized Voltmeter," Radio-Electronics, December, 1954.

-30-

Fig. 5. Over-all view of the simple channel tuner. Mounted on a polystyrene shelf-plate, this v.h.f. tuner is simple and has few components. Its construction is easily visible here.

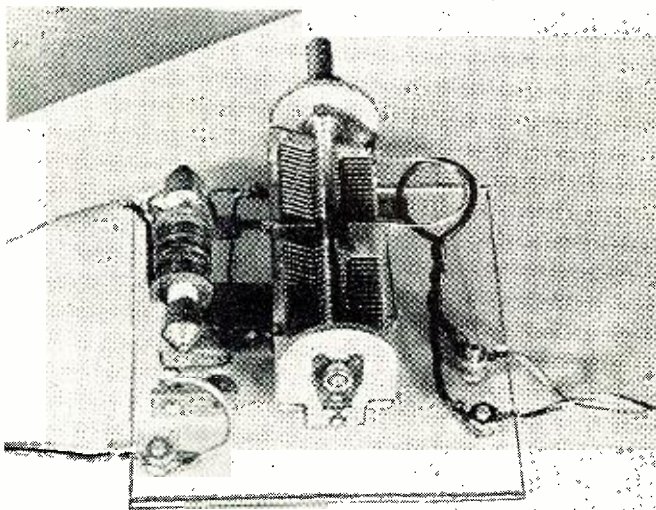
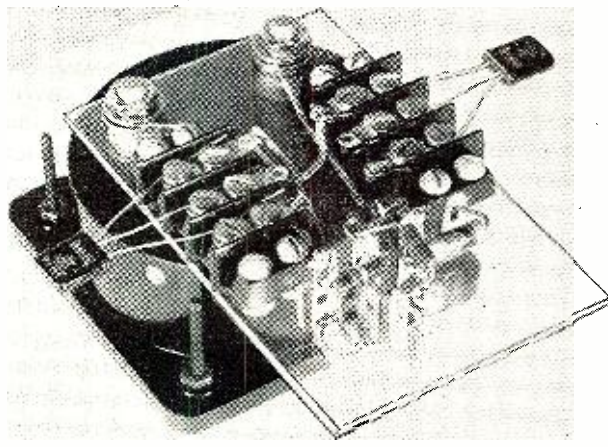

Fig. 6. The transistorized d.c. amplifier assembly. The entire unit, minus the zero-set potentiometer and range switch, is mounted on the polystyrene plate on back of the microammeter.





# A Low-Cost Frequency Standard

By PAUL S. LEDERER

An inexpensive unit for the ham shack which uses two low-cost, readily-available surplus crystals.

A FREQUENCY standard is a desirable item for the electronics experimenter and amateur radio station operator. Unfortunately a good standard crystal is fairly expensive, about \$8.00. It is possible, however, to build a high quality frequency standard using two crystals whose cost is less than one dollar for both.

After the last war, a great many crystals used by the Armed Forces were put on sale as surplus items. One particular type, for the SCR-508 in a FT-241 holder, was used for equipment operating on adjacent channels from 20.0 to 27.9 mc. These channels were 0.1 mc. apart. The crystals were ground

so that the 54th harmonic of each was the desired channel frequency. The actual crystal fundamentals range from 370.370 kc. to 516.667 kc. Such crystals, taken one at a time are not very useful. However, the difference in frequency between two such crystals may be an even number without fractions. Since each channel is the 54th harmonic of the crystal, if the difference between two channels is exactly divisible by 54, the difference between the corresponding crystal fundamental frequencies is an even number without fractions.

Thus, for example, channel 8 is on 20.8 mc., channel 62 on 26.2 mc.; the

difference between the two, 5.4 mc. when divided by 54 becomes 0.1 mc. or 100 kc. Therefore, if two oscillators were built using these two crystals and their outputs combined, a beat frequency of 100 kc. should result. Its accuracy would be a function of the accuracy of each crystal and of the effect of circuit components in the oscillators.

No information was available on the accuracy of the individual crystals and it was decided to build the oscillators and associated circuits and then measure the beat frequency obtained. The result fully justified the labor involved.

As measured on a Berkeley Electronic Frequency Counter (with an accuracy of about  $\pm 1$  part in  $10^6$ ), the beat frequency using the crystals specified was 100,050 cps.  $\pm 10$  cps. Thus the absolute accuracy of the standard is 6 parts in  $10^4$ , with a possible drift of  $\pm 1$  part in  $10^4$ .

The circuit consists of two Pierce oscillators using a 6SL7 double triode. Mixing is accomplished in a common cathode resistor and choke combination. Output from the cathodes is fed through a low-pass filter into a parallel resonant circuit, tuned to 100 kc. It is amplified by a 6SH7 pentode. An additional 100 kc. parallel resonant circuit across the output of this pentode further helps to remove unwanted frequencies, resulting in a clean 100 kc. signal with an amplitude of about 12 volts r.m.s. The resonant circuit in the output is fairly critical of loading hence only a short, low-capacity cable should be used for coupling purposes. It may be advisable to isolate the output by using a cathode follower stage. This was omitted for lack of space.

Frequencies other than 100 kc. may also be obtained by the proper combination of crystals; if the difference between two channels divided by 54 is equal to 0.5, the beat frequency will be 500 kc.

To simplify the problem of filtering, the two crystals should be chosen so that their fundamentals are much higher than the desired beat frequency.

The frequency standard is built on a small chassis and is powered by an external power supply. It draws 3 ma. at 150 volts regulated voltage. Voltage regulation is recommended (VR tube) to increase frequency stability.

One word of caution: these crystals are generally listed in advertisements by their fundamental frequency value with *fractions omitted*. For example, the crystal for channel 8 (20.8 mc.) whose actual fundamental frequency is 385.185 kc. will be listed as 385 kc., and the crystal for channel 62 (26.2 mc.) with an actual fundamental frequency of 485.185 kc. will be listed as 485 kc. The prospective builder of this crystal standard is therefore advised to either select the crystals by desired channel at the place where they are sold or else calculate the *exact* fundamental frequency of the crystal desired and then pick the correspondingly listed crystal.

Complete schematic diagram of the low-cost, easy-to-build frequency standard.

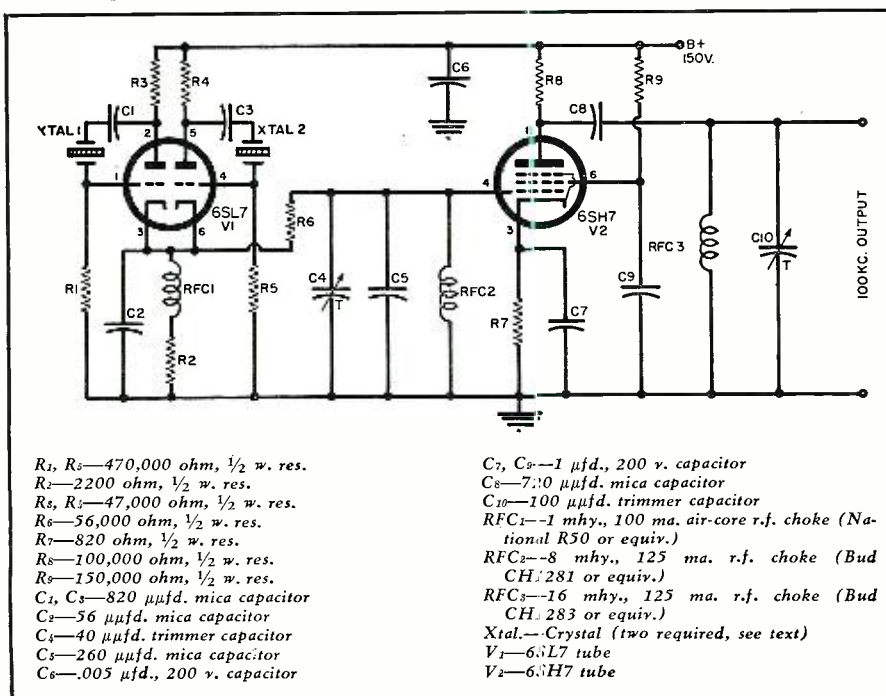



# Do You Need a Preamp-Control Unit?

By **BURT HINES**

**A**S THE display counters of most audio dealers will show, today there is an abundance of elaborate audio control units for the home music system. They present an imposing array of knobs, bars, buttons, and levers controlling a wide assortment of functions: "on-off" switching, gain control, input selection, record preamplification, record equalization, bass and treble control, variable bass and treble cut-off, loudness compensation, noise suppression, volume expansion, etc. These units are professional not only in appearance but also in design, construction, and materials. Therefore they are expensive, generally in the neighborhood of \$100 or more.

Where cost is little or no limitation in assembling a home music system there probably is no harm in owning a complex control unit except for the difficulty of instructing friends and family in its use.

However, in most cases cost is a limitation and the 20-20,000 question is whether the complex control unit offers added listening pleasure commensurate with its price. Would it not be wiser to buy a simple control unit—or an amplifier or tuner incorporating simple controls—and use the saving in a manner that will give more pleasure per dollar, such as buying a better basic amplifier or a better speaker?

The audiophile must decide this for himself, particularly if his interest inclines as strongly to gadgets as to music. However, there is a good deal of evidence that a modest control unit with a minimum of knobs will deprive one of little if any listening pleasure.

If the average listener visits a sound salon he will find that the differences among speakers and among sources of sound are far more astounding than the nuances of a sophisticated control unit. If he switches from LP to RIAA record position, or turns on a loudness compensator instead of boosting the bass control, or introduces 7000 cycles sharp cut-off instead of gradual cut with the treble control—he will not be suddenly transported to heaven. He may or may not perceive the fine differences made possible by the expensive control unit. But let him switch from one speaker to another and in this department he will almost certainly find a dramatic call for the expenditure of the most money he can afford.

To do a basically satisfactory job a

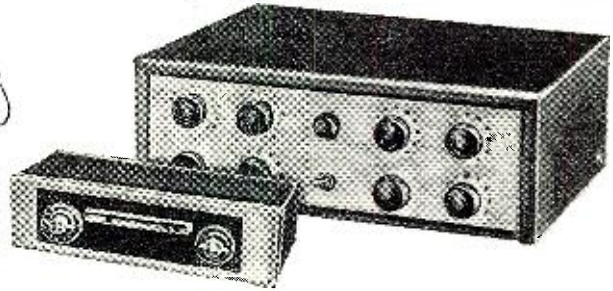
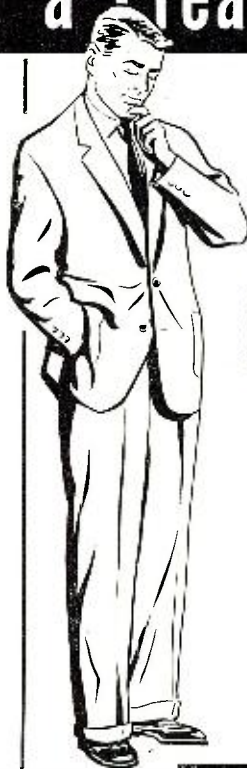

*To obtain maximum performance from your hi-fi system, you will need some form of preamp-equalizer unit—but "how elaborate must it be?" is a good question. Here are all of the facts—you make the decision.*

Table 1. Equalization requirements for several commonly-used recording curves.

Frequency	RIAA (also NARTB, New AES, RCA "New Orthophonic")*	Old RCA**	Old AES***	London and Columbia LP†, ††	Columbia 78†††
30 cps	18.6 db	—	22.5 db	14.0 db	—
50	17.0	24.0 db	18.0	13.3	17.0 db
70	15.3	20.0	15.0	12.5	14.0
100	13.1	16.5	12.0	11.0	11.3
200	8.2	9.5	6.5	8.0	6.8
300	5.5	6.0	4.5	5.5	4.3
400	3.8	3.5	3.0	4.0	3.0
500	2.7	2.5	2.0	3.0	2.1
600	1.8	1.5	1.5	2.0	1.3
700	1.2	1.0	1.0	1.5	.8
800	.7	.5	.5	1.0	.5
900	.2	.2	.2	.5	.2
1,000	0	0	0	0	0
2,000	-2.6	-2.5	-2.2	-3.0	-2.7
3,000	-4.8	-4.5	-4.0	-5.5	-5.3
4,000	-6.6	-6.5	-5.5	-7.8	-7.1
5,000	-8.2	-8.0	-6.7	-9.5	-8.9
6,000	-9.6	-9.5	-8.0	-11.0	-10.2
7,000	-10.8	-11.0	-9.0	-12.5	-11.7
8,000	-11.9	-11.5	-10.0	-13.5	-12.9
9,000	-12.9	-12.0	-11.0	-14.5	-14.0
10,000	-13.7	-12.5	-12.0	-15.5	-15.0
11,000	-14.5	—	-13.0	-16.3	—
12,000	-15.3	—	-13.5	-17.0	—
13,000	-16.0	—	-14.0	-17.3	—
14,000	-16.6	—	-15.0	-17.5	—
15,000	-17.2	—	-15.5	—	—

\*NARTB Engineering Handbook, 1949; Journal of the Audio Engineering Society, January 1954; RCA's "New Orthophonic" Recording Characteristic."

\*\*RCA, "Disc Record Recording Characteristic," 1950.

\*\*\*Audio Engineering, January 1951.

†London Records, Inc., "London Long Playing Records 33 1/3 Microgroove Recording Characteristic;" Columbia Records, Inc., "Columbia LP Microgroove Recording Characteristic."

††Since these two curves are at no point more than .3 db apart, they are lumped together.

†††Columbia Records, Inc., "Recording Characteristic, Columbia 78 rpm Commercial Pressings."



Frequency	Old RCA	Old AES	London and Columbia	Columbia 78
30 cps	—	—3.9 db	4.6 db	—
50	—7.0 db	—1.0	3.7	0 db
70	—4.7	.3	2.8	1.3
100	—3.4	1.1	1.6	1.8
200	—1.3	1.7	.2	1.4
300	— .5	1.0	0	1.2
400	.3	.8	— .2	.8
500	.2	.7	— .3	.6
600	.3	.3	— .2	.5
700	.2	.2	— .3	.4
800	.2	.2	— .3	.2
900	0	0	— .3	0
1,000	0	0	0	0
2,000	— .1	— .4	.4	.1
3,000	— .3	— .8	.7	.5
4,000	— .1	—1.1	1.2	.5
5,000	— .2	—1.5	1.3	.7
6,000	— .1	—1.6	1.4	.6
7,000	.2	—1.8	1.7	.9
8,000	— .4	—1.9	1.6	1.0
9,000	— .9	—1.9	1.6	1.1
10,000	—1.2	—1.7	1.8	1.3
11,000	—	—1.5	1.8	—
12,000	—	—1.8	1.7	—
13,000	—	—2.0	1.3	—
14,000	—	—1.6	.9	—
15,000	—	—1.7	.4	—

Table 2. Deviations of various recording characteristics from the RIAA recording standard. This information is based on the tabulated data given in Table 1.

control unit need have but four knobs:

1. "On-off" switch and gain control.

2. Selector switch with at least one phono position for magnetic pickups and three positions for inputs such as radio, TV, tape, etc. A single phono position for magnetic pickups would provide a compromise record equalization curve, such as the RIAA characteristic.

3. Bass control.

4. Treble control.

Compared with complex control units, the outstanding lacks of such a simple affair are a multiplicity of record equalization settings and a loudness compensator. Other missing features, such as sharp cut-offs and noise suppressor, are of secondary importance inasmuch as they are essentially designed to compensate for defective equipment or program sources rather than to achieve correct balance in musical reproduction. That is, they are in the nature of frills, while record equalizers and loudness compensators are basic to the reproduction of music with the greatest possible similitude to the original performance.

Where the audio budget is limited it is reasonable that frills should be omitted and attention focussed on the essentials, namely proper record equalization and loudness compensation. The purpose of this article is to show that a simple control unit with a good set of bass and treble controls does not require a great multiplicity of record equalization settings or a loudness control in order to achieve correct musical balance.

### Record Equalization

Let us assume that the control unit has but one phono position which provides RIAA equalization, the standard now accepted by most recording companies. Although this curve also correctly compensates NARTE, RCA

"New Orthophonic," and the *New AES* recordings, it will deviate from other recording curves, several of which are presented in Table 1. The amount of deviation of these other curves from the RIAA standard is shown in Table 2.

Now for the vital question: How many db deviation constitutes an appreciable difference? Listening tests and expert opinion seem to indicate that for single tones only differences above 1.5 db begin to be significant. When mixed frequencies are involved, as in most music, a gradual attenuation or emphasis over the range from 1000 cycles down to 50 cycles or from 1000 cycles up to 10,000 cycles begins to be noticeable when about 3 db boost or cut exists at the range limits of 50 or 10,000 cycles, using 1000 cycles as a 0 db reference.

By the mixed frequency standard, Table 2 shows no significant deviation in the treble range for any of the curves, although there is significant low-end deviation for all but the *Columbia 78* curve. By the single tone standard, there is significant deviation at both ends of the audio spectrum.

Using the more rigid single tone standard, it is possible to render all these deviations non-significant by making slight adjustments of the bass and treble controls from flat position. Fig. 1 shows some of the response curves effected by a set of good yet simple tone controls having the circuit configuration of Fig. 2. Using these response curves or interpolations between these curves, Table 3 shows the reduced deviations between the RIAA curve and other curves that can be achieved by correct tone control settings. No changes are shown for the *Columbia 78* deviations given in Table 2 because only in the area of 100 cycles is there departure, a very slight one, from the 1.5 db standard.

It is to be seen in Table 3 that with one additional minor exception all the deviations fall within the 1.5 db standard, the exception being that at 200 cycles the Old AES curve is 1.7 rather than 1.5 db apart from the RIAA curve.

The question naturally arises as to how one can make the correct bass and treble control settings for proper record equalization; after all, in the expensive control units the individual record equalization settings are explicitly marked on the panel. The answer, as for all questions in audio, is that the decision must be made by ear. The important thing is that a correct setting for record equalization *can* be achieved by use of a single equalization curve in conjunction with the tone controls. How far these controls should be turned for record equalization should be no harder to decide than how far to turn them to compensate for room characteristics, program material characteristics, listening level, individual preferences as to musical balance, etc. The reader who does not own a complex control unit should quickly be disabused of the notion that such a unit always precisely compensates for different recording curves. He has only to read the record reviews in various journals to see how frequently bass or treble adjustment is required in addition to the prescribed setting for the record curve in question. How much adjustment is of course left by the reviewer and the control unit to the listener's ear.

Recording curves are not precise nor precisely followed. The published curves are generally stated as having a tolerance of  $\pm 2$  db. In practice it appears that even greater liberties are taken. A friend who is with a leading recording company states that he has seen engineers boost the treble far beyond the tolerance of the company's published curve.

Another factor to be considered is that the musical balance of the original recording can be significantly affected by studio acoustic conditions and microphone placement. Consequently, precise adherence to a curve both in recording and playback may nevertheless leave the recording out of balance in the estimation of a listener who has heard the same music played elsewhere.

Finally it must be considered that the departures of speakers from flat response are marked, with peaks and valleys of 5 db or more being common even in the best of speakers. Moreover, the frequencies at which different speakers exhibit their peaks and valleys differ radically from one speaker to another. Consequently, alongside the gross imperfections of speakers in terms of accurate response, minor deviations of a control unit from correct record equalization are of little moment.

### Loudness Compensation

It is generally agreed that faithful reproduction of music at a sound in-



tensity level below the original performance level requires so-called loudness compensation.<sup>1, 2, 3</sup> The much discussed Fletcher-Munson curves show that as gain is reduced the human ear gives the illusion that bass frequencies, using 1000 cycles as a reference frequency, have dropped relatively more than high frequencies. Thus any given bass frequency requires a certain degree of boost when a home music system is operated at a sound level which, to the ear, is substantially below that of the original performance.

The loudness control seeks to reduce gain and at the same time automatically provide bass boost to the extent indicated necessary by the Fletcher-Munson curves. In short, it cuts bass frequencies at a lesser rate than frequencies above 1000 cycles.

However, the automatic loudness control is less automatic than it first appears. It requires a gain control, mounted either at the front or rear of the control unit (preferably at the front), which can be set so that the loudness control in its maximum position reproduces music at the original level as the ear hears it. But sound level varies from one record to another, from one type of musical selection to another, from a strong radio station to a weak one. Consequently, to achieve accurate loudness compensation for all sources of music one must continually manipulate the gain control in addition to the loudness control so that the latter may always represent original level at maximum rotation.

Therefore it may justifiably be asked: Why go to the additional circuitry, complexity, and expense of a loudness control if the bass control can supply the amount of boost required for loudness compensation? The purpose of this section is to show that a good bass control, with response curves such as those in Fig. 1, can supply the needed boost in nearly all practical circumstances.

References 1, 2, and 3 have convincingly demonstrated that the amount of bass compensation required is *not* that which will make a given bass frequency, say 50 cycles for present discussion, sound as loud as 1000 cycles at any intensity level. Actually a substantially smaller amount of compensation is required, compensation which seeks only to maintain the original loudness relationship of 50 cycles to 1000 cycles. Except in the case of music originally played at well above average intensity, the original level will generally cause 50 cycles to *sound* less intense than 1000 cycles even though each frequency is *produced* with equal measured intensity.

An example is helpful. For equal measured sound outputs, 50 cycles sounds about 6 db lower than 1000 cycles when 1000 cycles has a measured absolute level of 80 db (0 db = 10<sup>-16</sup> watts/cm<sup>2</sup>). But when 1000 cycles is at an absolute level of 60 db, 50 cycles sounds about 18 db lower than 1000 cycles. Therefore one must add 12 db boost at 50 cycles in

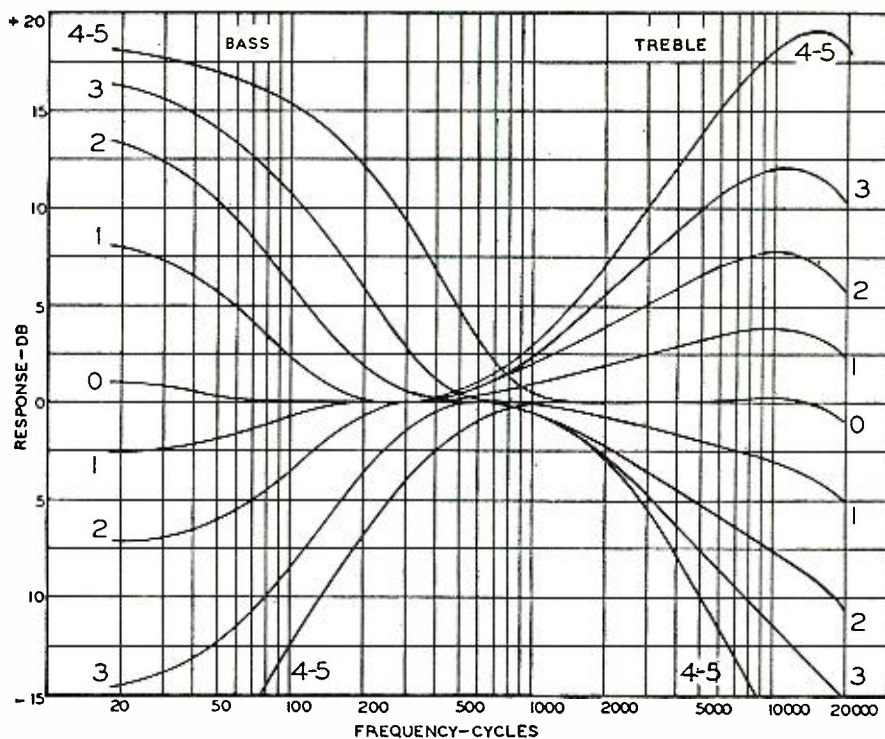

Fig. 1. Response curves effected by a set of good yet simple tone controls using the circuit of Fig. 2. Graph courtesy of Waveform, Inc., New York, N. Y.

order to restore the original 6 db loudness difference between 50 and 1000 cycles. It would be incorrect to boost 50 cycles 18 db.

The amount of loudness compensation required will of course vary directly with the degree of reduction from the original sound level. However, there is a practical, or one might say musical, limit to the extent of such reduction, as will shortly be shown, and correspondingly there is a limit to the required degree of loudness compensation. This compensation limit falls within the scope of the bass boost  
(Continued on page 108)

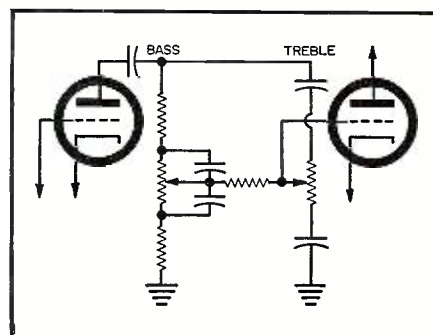

Fig. 2. Tone control circuit used in obtaining the curves shown in graph Fig. 1.

Table 3. Adjusted deviations of various recording characteristics from the RIAA curve, based on data in Table 2 and response curves shown in Fig. 1.

Frequency	Old RCA	Old AES	London and Columbia	Columbia 78
30 cps	—	— .9 db	— .4 db	—
50	0 db	.5	— .5	0 db
70	1.3	.5	— .7	1.3
100	.4	1.1	— .6	1.8
200	— .5	1.7	0	1.4
300	— .5	1.0	0	1.2
400	.3	.8	— .2	.8
500	.2	.7	— .3	.6
600	.3	.3	— .2	.5
700	.2	.2	— .3	.4
800	.2	.2	— .3	.2
900	0	0	— .3	0
1,000	0	0	0	0
2,000	— .1	— .4	.4	.1
3,000	— .3	— .5	.7	.5
4,000	— .1	— .4	1.2	.5
5,000	— .1	— .5	1.3	.7
6,000	.2	— .4	1.3	.6
7,000	.7	— .4	1.5	.9
8,000	.3	— .3	1.3	1.0
9,000	0	— .1	1.2	1.1
10,000	— .2	.3	1.3	1.3
11,000	—	.4	1.2	—
12,000	—	0	1.0	—
13,000	—	— .3	.5	—
14,000	—	0	0	—
15,000	—	— .2	— .6	—



# SYLVANIA

## TV Test Points

# for 1956

By  
**GEORGE C. CHERNISH, P.E.**

Senior Engineer, TV Design  
Sylvania Electric Products Inc.

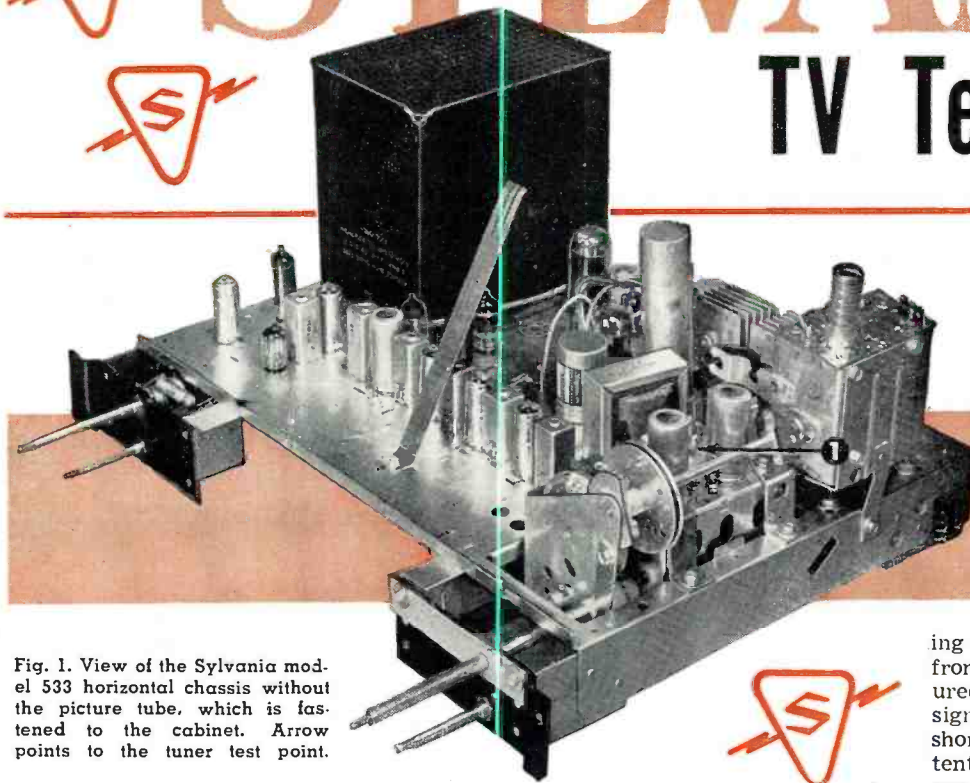

Fig. 1. View of the Sylvania model 533 horizontal chassis without the picture tube, which is fastened to the cabinet. Arrow points to the tuner test point.

*Be an expert in the servicing of these TV receivers,  
by using the test points described in this article.*

**S**YLVANIA engineers have designed two basic chassis for 1956. Model 532, used in the "leader" line, may be found in four table cabinet styles and two consoles, and is a vertical chassis. Model 533, a deluxe production, may be found in four table cabinet styles and three consoles, and is a horizontal chassis. Both were designed to operate picture tubes up to 24" without circuit changes of any kind. Both have cabinet-mounted picture tubes.

The horizontal chassis, shown in Fig. 1, can be removed in less time than it takes to pull off a back cover. In keeping with the current trend toward rapid servicing in the home, only two cabinet screws at the rear of the chassis need be removed. For this reason, few test points are provided on the top deck, although access can be gained readily to "B+," "B+ boost," a.g.c. line, and tuner connections.

Because of the high picture-tube potential employed (20 kv.), the back cover trips a safety switch on its removal which jumpers the high-voltage output to chassis ground.

Twin selenium rectifiers in a full-wave doubler circuit provide 260 volts

of filtered "B+." Except for the "Halo-Light" tube which has its own source of power, all tubes are fed from a common heater transformer, thus providing parallel-heater operation. This chassis is provided with a four-stage i.f. strip utilizing 6BZ6 remote cut-off pentodes. Another feature is the use of a special vertical-blanking stage having its own triode and pulse circuitry.

Fig. 1 shows the first test point, the converter grid in the v.h.f. tuner. Normal voltage here, as read on a v.t.v.m., averages  $-1.5$  volts. A zero reading, of course, indicates oscillator failure. If the oscillator has failed, check the other channels for output before blaming the whole tuner. Not infrequently, the tuner test point will reveal trouble on one channel only.

Occasionally, the technician may encounter another version of the tuner wherein the test point has a different internal connection. This is for r.f. alignment. A v.t.v.m. connected to the test point should read about  $+100$  volts on this version.

Fig. 2 shows the other test points on the deluxe chassis. Test point 2 (pin 1 of  $V_3$ ) is on the a.g.c. line. Depend-

ing on signal strength, a reading of from  $-1$  to  $-4$  volts should be measured, becoming more negative as the signal increases. Look for a gassy or shorted i.f. tube when a positive potential is indicated. If the a.g.c. voltage seems unusually high, even on weak signals, chances are that an i.f. stage is regenerating.

For severe picture overloading, horizontal pulling, or negative picture, observe the a.g.c. voltage as you try tuning to a few channels. Remove and replace the antenna leads; when little or no change in voltage results, check components in the a.g.c. circuit, particularly the line bypass capacitors. If any of these is shorted, the r.f. or i.f. tubes will have insufficient bias and will operate at high gain.

Insufficient a.g.c. will result if any changes occur in the r.f., i.f., or video detector circuits. Since a.g.c. voltage is developed by the video signal, a gassy i.f. tube, for instance, could cause a deficiency. Sometimes, a tube will draw grid current which leaks into the a.g.c. line in opposition to the a.g.c. voltage. Worst offenders of this type seem to be r.f. tubes.

To adjust the a.g.c. control correctly on these receivers, tune in a strong channel, with minimum contrast and maximum brightness. Adjust the vertical hold control so that the picture rolls downward slowly, allowing the vertical blanking bar to be easily observed, as in Fig. 3. Next, turn the a.g.c. control clockwise until the sync pulse starts to become lighter, or the blanking bar becomes as black as the sync pulse. Then turn back the control to the point where the sync pulse becomes prominent on the blanking bar.

Test point 3 (pin 2 of  $V_3$ ) is at the



output of the video detector. A v.t.v.m. reading of  $-3$  volts indicates that the tuner and video i.f. strip are passing the signal with required gain. It does not, however, denote complete normalcy; for traps could be a little off, or the video signal itself could be contaminated with hum—not to mention sync and white compression.

Connect an oscilloscope isolated by a 33,000 ohm resistor to the test point and examine the video detector output wave. If the horizontal axis is indented, as by a sine wave, hum is modulating the signal. Sixty-cycle modulation denotes probable heater-to-cathode leakage in one of the tuner tubes, or in a tube in the video i.f. strip. If the offending frequency is 120 cycles, undue ripple has developed in the low-voltage power supply.

As a rule, hum on the video signal creates one or two wide, dark bars in the picture. Since the power supply has full-wave rectification, two bars would appear if ripple developed in the "B+." When only one dark bar is visible, tune the picture in and out with the fine tuning. A heater-to-cathode short (or leak) has developed in the video-handling tubes if the hum bar disappears with the picture. However, if the amplitude of the hum is very low, the black bars would not be discerned on the screen. Nevertheless, even a small ripple on the video can cause poor vertical hold.

With the scope synced at one-half the horizontal frequency, a peak-to-peak reading of 4 volts should be indicated at test point 3.

Test point 4 (pin 11 of  $V_{23}$ , the picture tube) takes us to the output of the video amplifier. A normal signal should provide 60 volts peak-to-peak. At any rate, the gain of this stage should approach 15. This may be determined by dividing the voltage measured here by the reading at test point 3. If the gain is below 13, replace the 12BY7,  $V_5$ .

When no output can be read at this test point, look for an open variable peaking coil ( $L_{207}$ , Fig. 4). An open here would remove "B+" from the 12BY7. On the other hand, if the gain is much over 20, look for an open series peaking coil. This would indicate that the operating point of the video amplifier tube has changed, thereby increasing the gain unduly. Consequently, the frequency response would be restricted, resulting in detriment to picture quality.

Whenever a variable peaking coil is replaced, the new coil must be adjusted in the following manner:

Tune in a strong signal, set the contrast control near maximum (not critical), and adjust the brightness for a somewhat dark picture. Then, connect a v.t.v.m. across the 2  $\mu$ fd. electrolytic capacitor in the ratio detector. Adjust the fine tuning control until sound bars appear in the picture, then turn it back until the meter indicates the first dip in voltage. Be careful to adjust for the first minimum, since there will be a second and more-pronounced dip as the

fine tuning is rotated further. Finally, adjust the variable peaking coil until there are little or no trailing whites or blacks following dark regions of the picture.

With a v.t.v.m. connected to pin 7 of  $V_{13}$  (test point 5), measure  $-.3$  volt, plus or minus 10%. A reading on the oscilloscope here should average 10 volts peak-to-peak. This is at the grid of the horizontal sync clipper.

Examine the sync pulse closely for any sign of roughness in its contour. Unless the pulse appears clean, an aging 12AU7 is a likely suspect. If the characteristics of tubes and components drift to the point where faulty clipping occurs, fragments of noise and video information will penetrate the sync stages, causing erratic operation of the deflection system. A gassy tube in the front end or video i.f. sections will also roughen up the sync pulse. This could lead to pulling or weaving of the picture, with perhaps intermittent loss of stability.

If only the extreme upper portion of the picture weaves, it indicates that the sync pulse has been compressed. This, of course, can be detected on the scope. But loss of sync amplitude may occur in earlier stages. The noise inverter, for instance, could tend to clip sync, or alignment may have drifted to the point where the video carrier rides too low on the response curve. In general, however, when the picture (other than the very top) pulls horizontally,



Fig. 3. Vertical blanking showing the sync pulse, used for adjusting the a.g.c.

the trouble will lie in the sync separator.

Horizontal sync trouble often originates in the horizontal oscillator stage. Test point 6, at pin 3 of  $V_{18}$ , should measure  $+6.8$  volts on a v.t.v.m. A deficiency of 1 volt calls for a thorough check of the entire stage. Observe that all resistors here have a tolerance of only 10%. Measure these on an accurate ohmmeter and replace any whose value has drifted beyond this tolerance. An oscilloscope connected to this test point should give a reading of 325 volts peak-to-peak.

The a.f.c. test point (number 7 in Fig. 2) is at pin 1 of  $V_{17}$ . A scope sweeping at 7875 cycles should show 13 volts peak-to-peak at this point. Occasionally, when components age or are replaced, it may be necessary to re-align the a.f.c. stage, in which case the following procedure applies:

1. Tune in a strong channel.
2. Adjust the width control for approximately normal scan.
3. Short pin 8 of  $V_{18}$ , the 12AU7 horizontal sync clipper, to chassis ground. Connect a jumper across the terminals  
(Continued on page 100)

Fig. 2. Underchassis view of Sylvania model 533 horizontal chassis showing the test points which, if used as explained in the text, will aid in servicing.

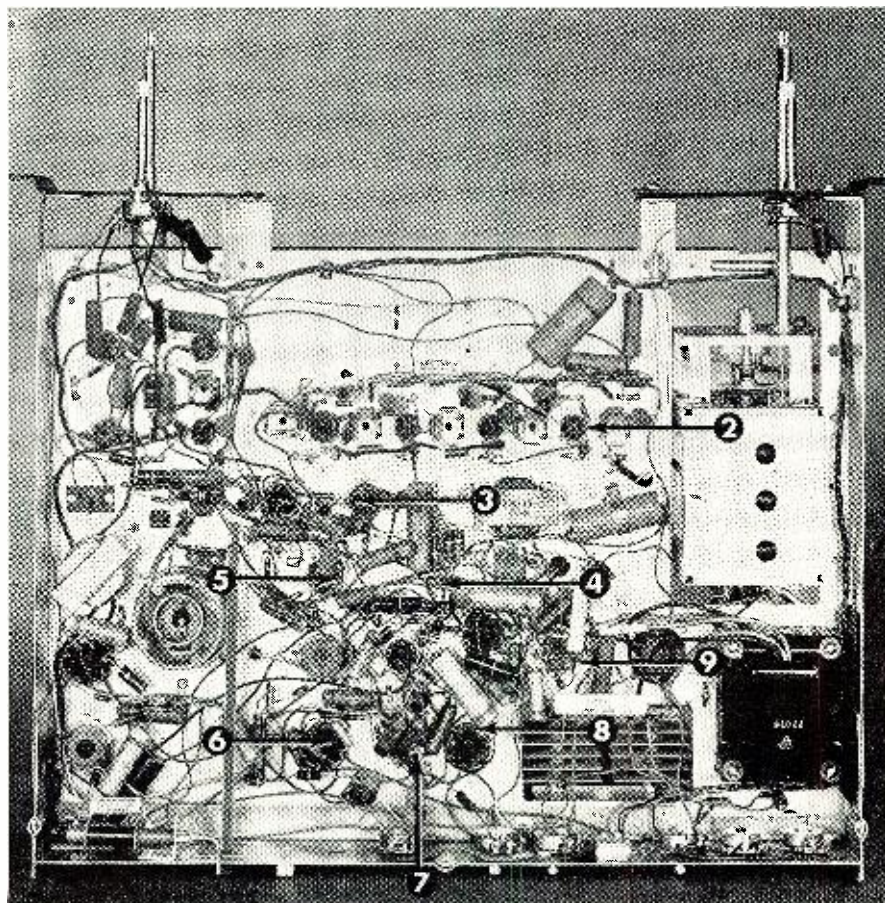



# Those Tough Dogs

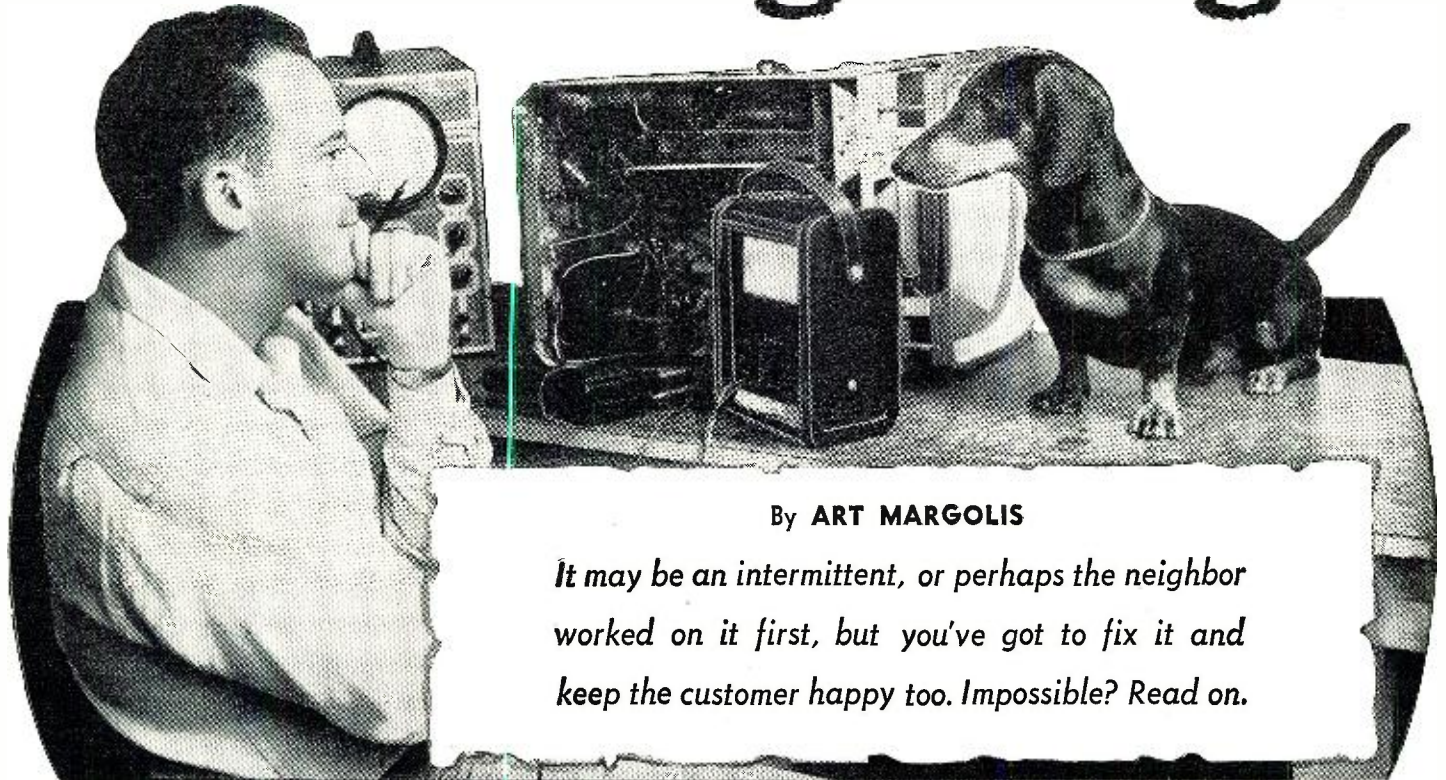

By ART MARGOLIS

*It may be an intermittent, or perhaps the neighbor worked on it first, but you've got to fix it and keep the customer happy too. Impossible? Read on.*

THE customer's shrill voice insisted, "I want my television set back! You've had it now over three weeks." You wearily answer, "I'm just as anxious as you are ma'am to bring it back. But we are waiting for a factory part that should be here in the next couple of days."

She yells back, "Well it better be here soon, goodbye!" and her hanging up hurts your ear.

Then you pick yourself up from the desk, plunk yourself down by the bench, and look at the exposed underside of the "dog" in question. A fleeting bit of guilt crosses your mind. You have just told a little white lie. Suppose the irate set owner knew there was no hard-to-get part? Suppose she really knew the truth? You are stuck on a "dog." You don't know yet what is wrong.

Big shop or small, crackerjack troubleshooter or beginner, if you fix TV's, out of every hundred jobs there are going to be a few sets of the canine variety. They make you swear, curse, and pray. They awaken you in the middle of the night with new theories of attack. They shake your confidence in your abilities. They make TV service seem like the worst kind of endeavor. They are the jobs where every "B+" string leads to a dead end. Where every component is torture to "unbutton" and then checks good. Where the television-addicted customer is constantly on the phone trying to get the set back. Where you have to keep telling fibs for you cannot explain the reason for the delay is that you do not know what is wrong.

These TV "dogs" can be isolated into

"breeds": the intermittent, the "one-in-a-million," the induced, and the eventual leaker. No doubt there are others.

A new 21" CBS-Columbia vertical chassis arrived on the bench one morning. A visual inspection seemed to reveal the trouble. A tiny 100  $\mu$ fd. mica from "B+" to ground was blackened. It had evidently shorted, pumping "E+" through itself to ground. Two resistors, a 1000 ohm and a 4500 ohm in its immediate vicinity were open, see Fig. 1. The shorted mica must have caused excessive "B+" to pass through the resistors.

The three disfigured components were replaced, and the set turned on. A raster promptly appeared. When an antenna was attached, video flickered on and audio blasted. All was well.

Just as the finishing touches were being applied to the job, it happened. The video went snowy and herring-boned; the sound garbled. Then they both "conked out" altogether. Just as suddenly, they came on again. Two hours later it did it again. This easy one had turned into an intermittent. Two days later it was still acting the same way.

Right then and there we paused and put into action our simple but effective "pressure alleviating policy." We called the set owner and explained, "Your set is almost completed. However there are still a few small things wrong with it and before we send it back we want it to be perfect. It will probably consume some time so if you'd like information call in periodically and we will give you a progress report. Please have patience and we're

sure you'll be pleased with your TV."

It was a week until we were able to pin this one down by a substitution and cook method. The 4.5 mc. intercarrier trap was located in the same can as the 3rd i.f. transformer. The 4.5 mc. trap was also directly in line with the two "deceased" resistors. The "B+" surge which had damaged them had also impaired the trap operation. As it opened up intermittently it affected the i.f. transformer's inductance and, thus, the video and audio symptoms.

A new can restored the original good performance. Even more pleasing, that one short phone call had enabled the customer to contain herself and still remain a recommendation producer.

One of the worst types of electronic "dogs" is a set that has been worked over by a nontechnician with a soldering iron. This special trouble class we call induced. As soon as we realize we have one of these, we set the record straight with the customer and won't accept the repair without a complete understanding.

We pulled a 17" Philco that was burning out the 3rd i.f. 6AU6, 6CB6 r.f. amplifier, and 12AV7 mixer-oscillator tubes as fast as we could insert their miniature prongs into their sockets. Underchassis examination revealed that the 1300-ohm wirewound, 9-watt "B+" load resistor was no longer in place. Instead, an 1800-ohm, 4-watt unit had been substituted (see Fig. 2). A glance at the set's schematic showed that the incorrect replacement was tied to a wrong filter. In place of the .7 ampere fuse there was a twenty ampere one. Big solder blobs were dotted throughout as mute evidence of



some previous mystery worker who had been both eager and misdirected.

We called the customer before starting and explained, "Someone has done quite a lot of damage to your television receiver. We will be glad to do the repair but because of the circumstances the price will probably be a bit higher than usual and the job will take a little longer than normal." She was well aware of what had happened and confessed that her next door neighbor had tried to fix the set but ran into difficulties. She gave us the "go ahead."

We allocated an hour every afternoon to this "dog." In eight days it was working again but it had been a real struggle. The first thing we found was that the "B+" dropping resistor was heating up because it wasn't rated high enough. As it got hot its resistance decreased tremendously in negative temperature globar fashion. This threw better than three-hundred volts onto the third i.f. which was supposed to get only 135 volts, the r.f. amplifier which should have had but 155 volts, and the mixer-oscillator where 125 and 80 volts respectively were normal. These plates drew excessive cathode electrons and burned out. The heavy current flow would undoubtedly blow the .7 ampere fuse which was why the twenty ampere one was inserted.

We changed the resistor to its proper value and the fuse remained intact and a raster came on, but still no audio or video. In carefully checking wire by wire, component by component, six wrong connections were uncovered. A new 12AV7 video tube brought in the picture and a new 7C5 audio output tube returned the sound. However, the video was weak and negative.

After hours more of wire by wire scrutiny, an 1800-ohm video plate resistor was found to be missing. A "B+" line that had no business being there, was tied to that same video amplifier plate. This was evidently the neighbor novice's first big confusion that started the whole mess. Removal of the line and the addition of a new resistor did it. The picture and sound snapped back.

It's hard to describe the feeling of cloud sailing a TV service technician gets after licking a tough "dog." It's also hard to depict the stomach-turning despair that occurs when he is stuck on a stubborn television set and there seems to be no answer. To ask for help is also an admission of defeat. Yet eventually, every one of us, no matter how expert, is going to run into a "dog" that will successfully resist every effort hour after hour after hour.

Is it a sensible business move to keep banging your head against the bench? When a general practitioner MD runs into something that for the moment stumps him does he take chances and keep plugging at it? No! He calls for a specialist. Well, a TV technician who works on thousands of makes and models is in a sense a general practitioner. The boys in the distributor service shops who work on

only one make day-in, day-out are specialists on that particular make. Also they are very able and quite anxious to help you with your real bad "dogs." Our company makes liberal use of their skills.

A 21" G-E came into the shop a few weeks ago after the owner described these symptoms. As long as he had owned the set the sync was unstable. There was a slight pulling horizontally and the vertical sync was never as stable as it should be. Whenever the customer turned the contrast control complete sync loss would occur for a few seconds. Now, he said, it was impossible altogether.

When the set was first turned on the picture came in crisp and clear for about a minute. Then it started to pull sideways like a carnival mirror. The video overloaded, the picture went negative, the sound buzzed, it lost sync, then suddenly, miraculously cleaned up to perfection. It kept doing this.

There were three definite clues to the trouble. One, a.g.c. overloading; two, snow; and three, a seeming loss of frequency response. We looked for one likely part that would cause all that and sure enough found it, a peaking coil in the a.g.c. line, see Fig. 3. The theory underlying the video destruction fell into place. The coil was upsetting the sensitive bias of the r.f. amplifier thus giving snow. It was removing the a.g.c. bias on the i.f.'s, thus overloading the video. It was also hurting the frequency response of the picture which is its original function. A new coil stopped all that.

However, if the contrast control was turned either up or down, sync would be lost for a few seconds. We looked for another bad part. A week later we were still in the same fix. Then, we called the G-E distributor and got a benchman on the phone. We didn't think he could help but told him our troubles anyway. Without even hesitating to take a breath, he told us to

Fig. 1. The shorted capacitor indicated in this partial schematic diagram of a 21" CBS-Columbia TV receiver, allowed excessive "B+" to pass through this circuit, damaging the resistors and trap.

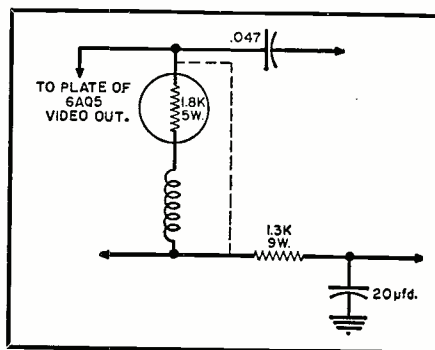
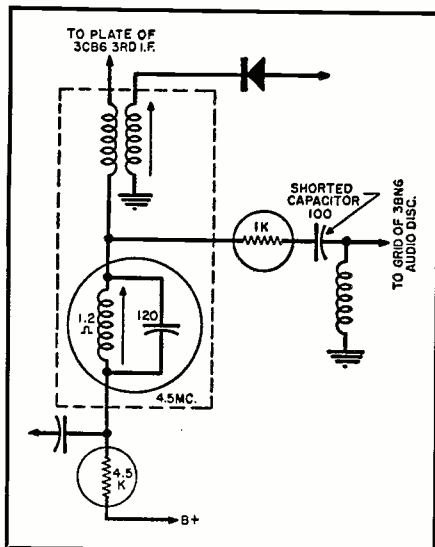

Fig. 2. The dotted line shows the wiring mistake which was made by a neighbor on a customer's 17" Philco TV receiver. This started a chain of rewiring and replacements that resulted in a "dog."

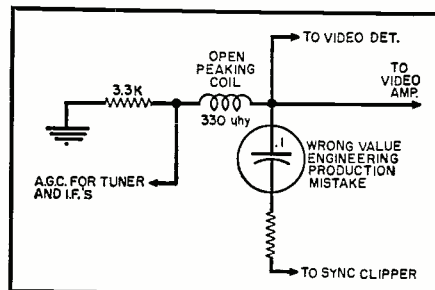

Fig. 3. Consultation with the local G-E distributor's service department helped service the set whose partial diagram is shown here. An incorrect capacitor inserted at the factory, caused the trouble.

change a .1  $\mu$ fd. capacitor that was next in series with the peaking coil to a .05  $\mu$ fd. He explained that the loss of sync was due to the .1  $\mu$ fd. capacitor making the time constant of the circuit too long so that the a.g.c. re-adjusted itself too slowly. The modification would speed it up. It did!

The unfortunate thing about "dogs" is, not only do we have such a conflict with them technically, but quite often we can't get the price the job is actually worth.

A 12" Emerson that we repaired not long ago was an example of this. The original symptoms looked innocent enough, one of the series heater strings did not light up. The 25W4 had a heater-to-cathode short and a 55-ohm heater resistor open (see Fig. 4). After they were replaced, only half of the defunct string came back on. Two of the tubes that did come on, a 25L6 and a 12BH7, lighted up like they were about to explode. The set was shut off. After much resistance checking, a 1500  $\mu$ fd. capacitor from the heater string to ground was found which measured 320 ohms. It was sending "B+" through the heaters of the tubes. After it was changed and the set turned on again the 25L6 and 12BH7 lighted up again.

Some more resistance checking showed the trouble to be only a heater-to-cathode short in the 12BH7. A new tube, and the string came on properly. However, there was no sound or video, only a 60-cycle hum bar. That was easy to fix, a 6AU6 i.f. tube which had

(Continued on page 94)



# A HOME MUSIC SYSTEM



Basic units used in hi-fi system—Garrard Model RC80 record changer, Heathkits: WA-P2 preamplifier, W-5M power amplifier, and FM-3 FM tuner.

*One of a thousand or more combinations that could be assembled to make up your hi-fi music system.*

THE scene depicted on this month's cover is fairly typical of what is taking place in hundreds of thousands of living rooms throughout the country. While the actual equipment may vary in complexity from home to home—this installation might be considered "representative" since the hi-fi fan has selected his components from the offerings of several manufacturers and has assembled his own "system."

Hi-fi fans can be roughly grouped into two classifications. The first type is the dyed-in-the-wool audiophile, like the man on the cover, whose pride and joy is in building some of his own equipment and assembling all the components into a unified "system." He makes a real effort to study the operation of each of his units so that he can speak with some authority on this interesting medium.

The other type of hi-fi fan, although no less eager in his pursuit of his hobby, lacks the technical "know-how" or the self-confidence to build his own equipment. He is the type of audiophile

who will buy a "packaged" unit consisting of one or two cabinets which will house the components selected and assembled for him.

His reasons for wanting a "complete deal" range all the way from a lighter touch on his pocketbook to a feeling of inadequacy when it comes to assembling such systems. Often his lack of confidence in his ability to interconnect the various components comprising a hi-fi system is misplaced since the job is relatively simple. Most units nowadays come complete with clear and explicit instructions for hooking them up. The awe with which "electronics" is viewed by many is still a deterrent to some people.

The fact that many such "packaged" systems are lower in price than the total cost of individually-assembled units indicates that the ultimate in sound reproduction is not obtained. For the most part, these are well-engineered jobs whose development "at a price" is a real tribute to the manufacturer's skill. Emphasis is placed on

mass production and the marketing of such units brings the equipment within the budgets of many who could not otherwise enjoy such luxury. For the most part, packaged systems selling for \$600 and up offer sound reproduction of highest quality.

This month's cover depicts what can be considered a typical setup for the average serious audiophile. Although the units are laid out in the corner of the room for photographic purposes, in an actual installation, the power amplifier, record changer, preamp, and tuner might be cabineted in some type of housing that would suit the home decor or meet the esthetic requirements of the owner. There is another, more current trend which dictates that tuners, preamps, and record changers were meant to be "seen as well as heard." In such instances the units are cabineted in attractive housings with handsome front panel escutcheons and matching enclosures. The power amplifier, on the other hand, continues to be housed in a cabinet, a closet, or some out-of-the-way place where it can do its work unobtrusively.

The units shown on the cover are, from left to right (clockwise), the Garrard Model RC80 record changer which sells for \$49.50 less cartridge (with a General Electric variable reluctance cartridge, sapphire needle, the price \$56.50), the Jensen "Tri-Plex" enclosure (TP200) and multiple speaker system, the Heath Model W-5M power amplifier which comes in kit form for \$59.75, the Heath WA-P2 preamplifier kit (at \$19.75), and the Heath Model FM-3 FM tuner which sells for \$24.50 as a kit. Thus a high-fidelity music system is available for a total investment of \$160.50, excluding the speaker or speakers and enclosure. In addition, if an over-all cabinet is required to house all of the equipment, it would mean an additional expenditure.

The cost of the speaker network and enclosure varies considerably. They can be obtained for as little as \$45.00 or as much as \$1000 or more. The audiophile has a wide choice and final decision will obviously depend on the amount of money available for investment in this component.

The setup shown on this month's cover is only one of literally hundreds of systems that could be assembled from the many components on the market—some ready to be installed or, like the Heath units shown, available only in kit form. If the job of building audio equipment, simple though it may be, strikes terror in the hearts of would-be system owners, there is always the helpful neighbor with a flare for things electronic or a local service shop which can whip the units together in jig time for a modest fee.

With all of the choices now available to the music lover—everyone can "get into the act" at his own level. —50—

RADIO & TELEVISION NEWS



# New Tube Tester Data

Bring your roll chart up to date for the new tube types. Future data will cover other service-type tube testers.

## JACKSON MODEL 715/115

TUBE TYPE	FILA-MENT	X	PLATE	YZ
3A2	3	23467	37	8 Q
3BA6	3	—	14	2 LMS
3BZ6	3	—	26	3 JKMKQ
3CF6	3	—	30	2 LMS
4BC8	4.2	—	17	2 LR
			17	4 NR
5B8	5	—	18	9 LR
			32	7 MOQ
5BF8	5	—	20	4 JNPS
			18	3 KR
6AS8	6.3	—	43	7 JKLR
			27	4 Q
6AU8	6.3	—	18	9 LR
			32	7 NOQ
6AX8	6.3	—	35	5 RS
			10	2 PS
6AZ8	6.3	—	30	2 JLQ
			20	6 PR
6BA8	6.3	—	23	7 JOR
			20	9 LR
6BC4	6.3	3567	35	4 RS
6BC8	6.3	—	17	2 LR
			17	4 NR
6CB5	6.3	235	8	8 JMP's
6CM7	6.3	—	11	2 OS
			28	4 NR
6CN7	6.3	7	30	6 NQ
			30	2 Q
			30	3 Q
6DE6	6.3	—	30	2 LMS
6DG6	6.3	—	8	2 JLMS
6DN6	6.3	—	15	8 MPR
6CS7	6.3	—	18	2 S
			18	4 NS
12AB5	12.6	46	18	7 JKS
12AV5	12.6	36	8	4 NPS
12BR7	12.6	7	25	2 LQ
			30	4 Q
			30	5 Q
12BV7	12.6	47	20	5 JOR
12C5	12.6	2	15	5 KMR
12CR6	12.6	—	22	2 JMN'R
			33	6 Q
12CS6	12.6	—	26	2 LMNS
25CA5	25	6	16	5 KMR
25DN6	25	—	15	8 MPR
6550	6.3	—	8	2 JLMS

## JACKSON MODEL 648

TUBE TYPE	FILA-MENT	D	E	PLATE TEST
3BZ6	3	AC1234	567	16 WY
4BC8	4.2	A123	A45	39 V
		A127	A89	39 V
5BF8	5	A1237	AC680	50 V
		A123	AC45	68 Z
6AZ8	6.3	A128	AC345	16 WY
		A129	AC67	34 WZ
6BA8	6.3	A128	679	32 WZ
		124	A35	25 WZ
6BC8	6.3	A123	A45	39 V
		A127	A89	39 V
6CM7	6.3	A123	A89	65 V
		126	A47	35 Z
6CN7	6.3	A128	A79	32 WX
		123	5	60 X
			4	60 X
6CS7	6.3	126	AC34	35 Z
		127	A89	70 Z
6DN6	6.3	124	AB369	18 V
12AB5	12.6	129	B346	35 W
12CR6	12.6	AC123	AC455	25 YZ
		C123	7	80 X
25DN6	25	124	AB369	18 V

**M**ANY service technicians and other users of tube testers cannot test many of the new tube types currently in use in TV receivers and other equipment because they have not replaced the old roll chart originally furnished with the instrument with a new one. Almost all tube tester manufacturers make up new roll charts for their instruments every year and these may be obtained simply by writing to the manufacturer and requesting the latest one for your model. They are nominally priced. In almost every case, a new roll chart can be inserted in the tube tester in a matter of minutes.

Between the time when the last roll chart was printed for a particular tube tester and the next one will be available, new tubes make their appearance. Since these are not covered by the last roll chart, the technician will not know where to set his tube tester switches for a proper test. The data published here and in succeeding issues will furnish this information for most of the commercially available tube testers.

In the table below for the *Knight* tube tester, the numbers in dark type indicate the necessary settings for the "short" test.

## KNIGHT MODEL 142

TUBE TYPE	A	B-FILAMENT	C-LOAD	LEVER POSITION UP	LEVER POSITION DOWN
2AF4 (Adapt BX)	2	2.5	21	<b>1267</b>	<b>45</b>
3BY6 (Adapt BX)	2	5	20	16	<b>24</b>
3BY6 Test 2	1	5	27	57	<b>24</b>
3BZ6 (Adapt BX)	2	5	20	1567	<b>24</b>
3CF6 (Adapt BX)	1	5	19	1567	<b>24</b>
(No open element test on pins 5 and 7)					
4BQ7A Tests 1-2 (Use BY adapter)	2-2	5	20-20	12-67	<b>34-48</b>
4BZ7 Tests 1-2 (Use BY adapter)	2-2	5	21-20	67-12	<b>48-34</b>
5AM8 Tests 1-2	2-1	5	20-19	2369-8	<b>15-57</b>
5AN8 Tests 1-2	2-2	5	21-20	12-678	<b>35-59</b>
5AQ5	3	5	20	<b>1567</b>	<b>24</b>
5AT8 Tests 1-2	2-2	5	21-20	12-6789	<b>35-35</b>
5AU4 Tests 1-2	3-3	5	25-25	4-6	<b>8-2</b>
5AV8 Tests 1-2	2-2	5	21-20	23-689	<b>15-57</b>
5B8 Tests 1-2 (No open element test on pin 9)	2-2	5	21-21	23-689	<b>15-12357</b>
5BK7A Tests 1-2	2-2	5	20-20	67-12	<b>58-35</b>
5J6 Tests 1-2	2-2	5	20-20	16-25	<b>47-47</b>
5U8 Tests 1-2 (No open element test on pin 6)	2-2	5	20-20	19-236	<b>58-57</b>
5V6	3	5	21	345	<b>178</b>
5X8 Tests 1-2	2-2	5	22-21	23-789	<b>56-156</b>
6AN6 Tests 1-2	1-1	6.3	23-23	2-3	<b>67-67</b>
6AN6 Tests 3-4	1-1	6.3	23-23	4-5	<b>67-67</b>
6AR8 (No open element test on pins 8 and 9)	2	6.3	20	3689	<b>1257</b>
6AUS Tests 1-2 (No open element test on pin 9)	2-2	6.3	21-21	23-789	<b>14-46</b>
6AX8 Tests 1-2 (No open element test on pin 6)	2-2	6.3	20-20	19-236	<b>58-57</b>
6CB5	2	6.3	22	<b>1458</b>	<b>236</b>
6CG7 Tests 1-2	2-2	6.3	23-23	12-67	<b>34-48</b>
6DA6	3	6.3	18	1567	<b>24</b>
12AV5-GA	3	12.5	18	158	<b>23</b>
12BK5	2	12.6	21	<b>1378</b>	<b>43</b>
19AU4	4	19.6	18	5	<b>38</b>
21A6 (No open element test on pin 0)	3	19.6	16	<b>1267890</b>	<b>35</b>
25BK5	2	25	21	<b>1378</b>	<b>46</b>
25CA5	3	25	17	<b>2567</b>	<b>14</b>
25CU6	3	25	17	450	<b>78</b>
5690 Tests 1-2	3-3	6.3	17-17	3-5	<b>24-78</b>
6463 Tests 1-2	2-2	6.3	21-21	13-68	<b>245-457</b>
6550	3	6.3	17	345	<b>78</b>



# An Improved

Top chassis view of the simplified "3D" converter. This improved version incorporates a self-contained power supply which will also operate a separate tuner or preamp to be used with this system.

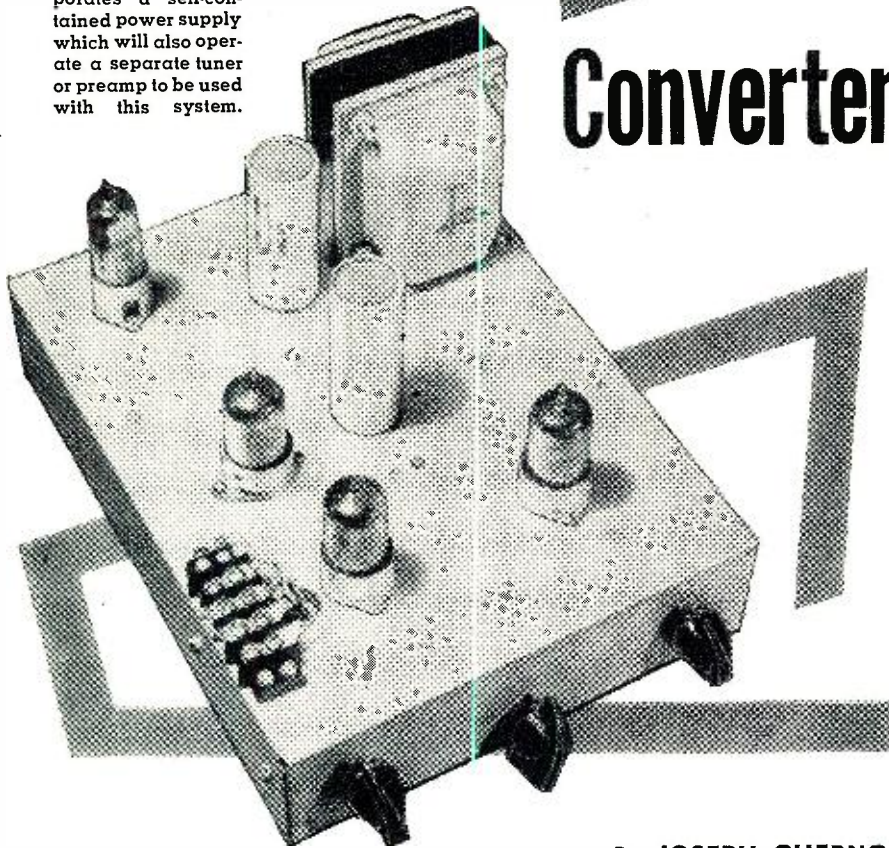

# "3D" Converter

By JOSEPH CHERNOF

*A simplified and improved version of a circuit originally described in the November 1954 issue.*

SINCE publication of the author's article, "The Poor Man's 3D Converter," in the November, 1954 issue of RADIO & TELEVISION NEWS, a number of interesting comments have been received from readers who have constructed and experimented with the unit.

On the basis of this material and other work, a new unit has been developed which has proved to be a considerable improvement over the original. An internal power supply has been added and provisions have been made for utilizing the unit to supply power to a separate preamp or tuner in a custom installation. Separate audio inputs are provided to accommodate both low- and high-level audio signals. The bass predominant channel gain has been reduced to bring it more in

line with that of the treble predominant channel. Feedback has been added to the input preamp stages to improve their frequency response

Fig. 1. Block diagram of the complete "3D" system. Although dual output amplifiers and speakers are required, ordinary units will work as well as high-fidelity equipment.

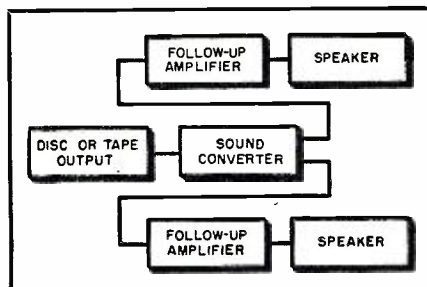

and linearity. Low-frequency performance of the unit has been improved by using larger coupling capacitors. Capacitor  $C_6$  has been made larger to provide a smoother crossover for the bass and treble channels.

The original "3D" converter was designed to provide the audio experimenter with a means of capturing the illusion of depth and liveness associated with true stereophonic or binaural sound at a fraction of the cost and complication involved in assembling either one of these two systems.

The "3D" converter attempts to convert ordinary monaural sound, as supplied from phono pickup or tape, to simulated stereophonic sound. This is accomplished by electronically separating the single sound input channel into two separate output channels, sufficiently different in phase and frequency structure from each other to simulate, say, the sound output of a symphonic orchestra as picked up by two separate microphones on a live recording stage.

The two sound output channels from the converter are followed by two separate external amplifiers and speaker systems so that recombination of the synthetic stereophonic sound takes place only at the ears of the listener as is the case with true binaural or stereophonic sound.

A block diagram of the complete "3D" system is shown in Fig. 1. While dual output amplifiers and speakers are required, very ordinary units used in this system will give results superior in most respects to a high quality monaural sound system. One possibility would be to use the audio section of a good console radio or TV set for the second sound channel.

The schematic diagram of the improved unit is shown in Fig. 2, with typical operating voltages indicated on it. The first two stages utilize both sections of a 12AX7 twin-triode in a conventional preamp circuit. Ample gain is available for a magnetic cartridge or other low-level signal source. No attempt is made to incorporate any specific means of equalization since a complete "3D" system will have a multitude of tone and volume controls on the various units to accomplish this.

The output of the preamp stages is fed through the master gain control,  $R_6$ . High level input signals from a crystal or ceramic cartridge or tuner are fed in at this point. In this connection, the jumper between terminals 2 and 3 of  $J_1$ , a 4-terminal Jones barrier strip, is removed. From the master gain control, the amplified input signal is coupled to the grids of triode sections  $V_{2A}$  and  $V_{2B}$  which comprise the bass and treble predominant channels respectively. Each channel has its own gain control.

The phase and frequency structure of the original signal are modified by means of selective feedback in each of the two channel amplifiers to provide the desired stereophonic effects. The separate outputs of  $V_{2A}$  and  $V_{2B}$  are coupled to individual cathode-fol-



lower triode sections,  $V_{8A}$  and  $V_{8B}$ , to provide isolation and also to permit the follow-up amplifiers to be located at some distance from the converter.

The power supply is conventional in design, using a 6X4 rectifier and a Triad R-7A power transformer. Very heavy filtering and decoupling networks are used. Since the total "B" current drain of the unit is very low, less than 6 ma., filter resistors are used rather than chokes.

As shown in the accompanying photos, a 15-pin male Winchester connector is mounted on the rear of the unit. The a.c. power is supplied through the associated female connector. This arrangement allows the unit to plug into a complete sound assembly, with a common "on-off" switch for several units. It also provides a handy outlet for "B" or filament power to be taken out of the unit to operate an external preamp or tuner as well as a very flexible means for connecting input signals into the unit for a custom installation where all wiring is to be concealed. Conventional parts and construction are used throughout except that disc ceramic capacitors are used instead of tubulars to conserve space.

Readers who have wondered whether or not stereophonic sound is for them

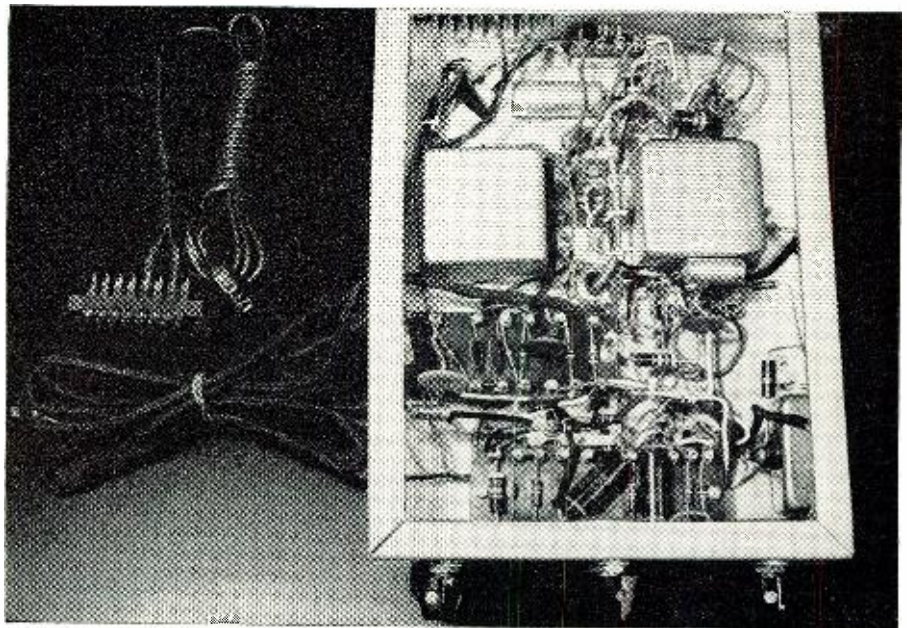

Under chassis view of unit. Construction is conventional and no problems should be encountered by the builder. Disc ceramic capacitors are used to conserve space.

can make the experiment with this equipment without investing a fortune in stereophonic head and pickups, dual amplifiers, and double speaker systems. While no claims are made that

this "3D" converter is anything but a simulated stereophonic system, it will provide a fairly good idea of the type of performance that you can expect from a true stereo setup.

-50-

Fig. 2. Schematic diagram and parts list covering an improved "3D" converter. Standard, easily obtainable parts are used throughout.

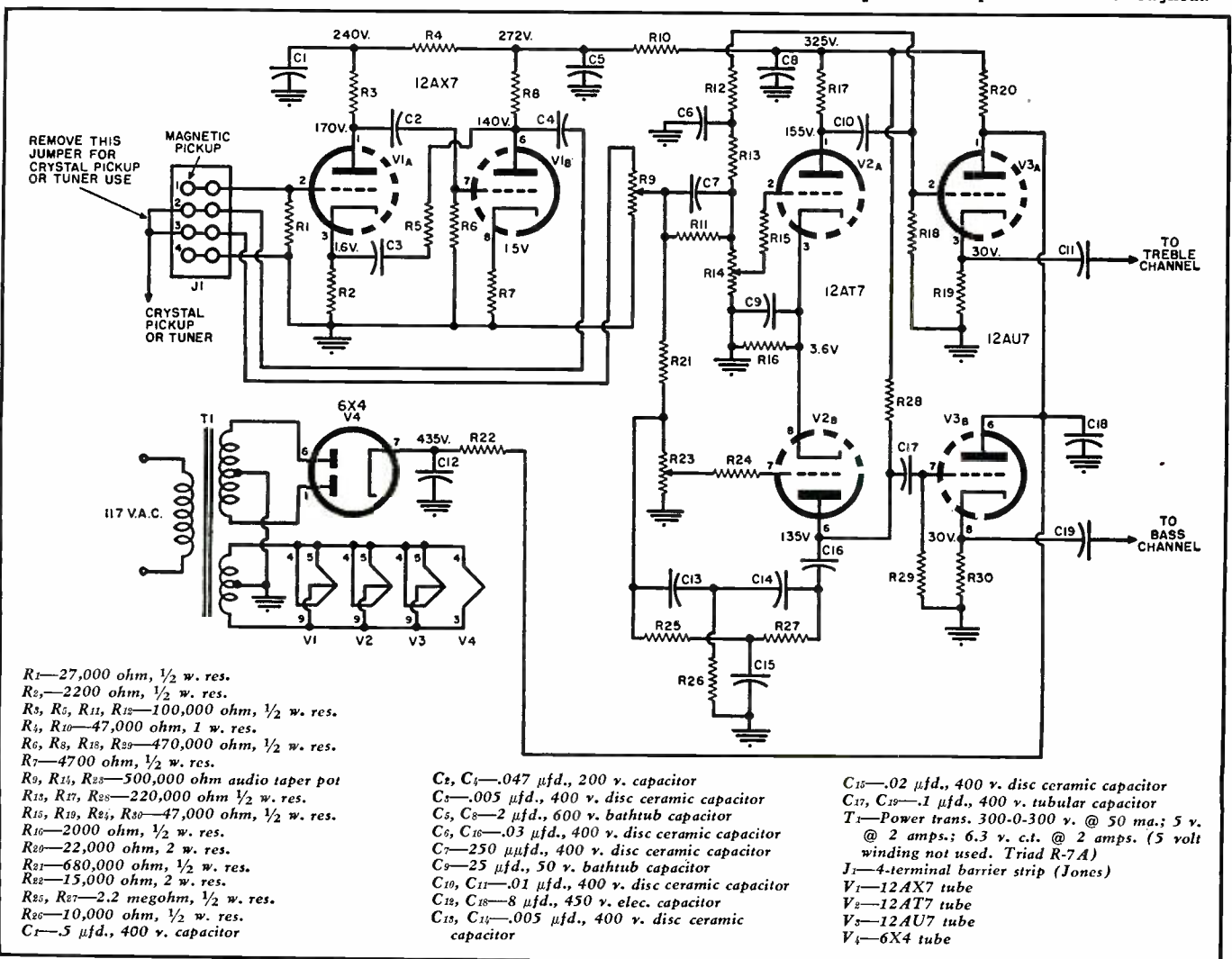



# EVOLUTION of the PHONOGRAPH

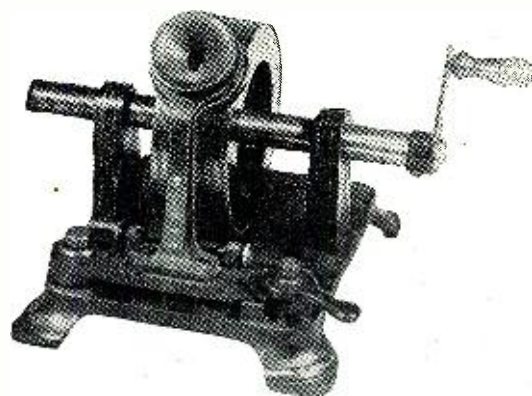

Fig. 3. A single diaphragm and stylus simplified the phono of 1878.

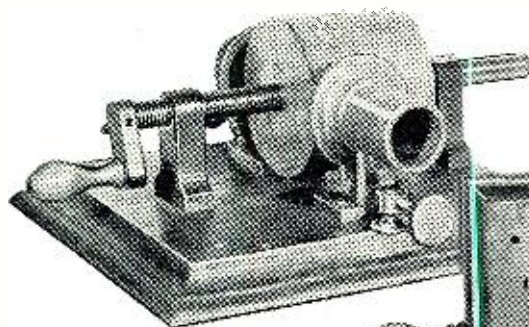
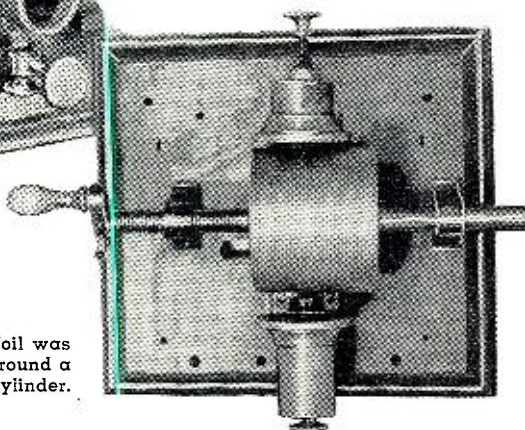

Fig. 1. The original phonograph of Thomas A. Edison. It was patented Feb. 19, 1878.

Fig. 2. A piece of tinfoil was wrapped completely around a threaded drum-type cylinder.



## Part 3. Earliest phonographs were hand-powered, electric-powered, foot-powered, and water-powered.

THE original tinfoil phonograph of Edison was first developed in the year 1877. A complete description of and operation applying to this discovery are revealed in Part 1 of this series. Edison's original machine, Fig. 1, employed a metal drum on which a thin sheet of tinfoil was wrapped. Sound was indented into the foil by means of a stylus actuated by a thin metal diaphragm.

The setscrew shown in Fig. 1 below the recorder permitted adjustments to be made in the stylus pressure. Attached to this recorder was a flexible tube which terminated in a rubber mouthpiece. A bird's-eye view of the tinfoil machine, Fig. 2, shows a similar arrangement of the reproducer used in the playing back of the sound previously recorded on the foil. Another setscrew was provided beneath the reproducer so that lateral adjustment could be made and accordingly to provide flexibility to the reproducing stylus. This was of steel and attached to the center of a thin diaphragm. This is the actual machine on which Edison recorded "Mary Had a Little Lamb" on August 15, 1877. The original model was loaned to the *South Kensington Museum* in London, and was returned to Edison many years later on October 20, 1928. It may be seen at the *Thomas*

*A. Edison Foundation Museum* in West Crange, New Jersey, where this and other early developments of Edison are on permanent display. Its curator, Mr. Norman Speiden, is a renowned authority on the inventions of Thomas A. Edison and will welcome our technically-minded readers who are interested in the inventions of the "Wizard of Menlo Park."

Edison produced a smaller model of his tinfoil phonograph the following year in 1878, Fig. 3, and this contained a few minor improvements over his original machine. It employed cast metal parts comprising a heavy base and the necessary supports for the driving screw. This particular model combined the functions of recording and reproducing with one diaphragm. Simplification resulted in greater economy and compactness, making this machine more popular with the purchaser. In operation, the metal assembly supporting the mouthpiece and reproducer could be swung away from the cylinder so that a sheet of tinfoil could be wrapped thereon. A locking device held the assembly firmly in place during use. Lateral adjusting screws were provided, so that the stylus could be accurately centered to the groove on the large cylinder drum. Only a very few of this model was produced.

In order to publicize the wonders of the phonograph, a quantity of demonstration machines was manufactured, Fig. 4, late in the year 1878. About six hundred of these were made to demonstrate the principle of the phonograph. It was indeed a cumbersome device. It employed a long shaft comprising the feedscrew, a drive wheel, and a weighted wheel required to stabilize the rotation. This model also employed a single diaphragm which was used as shown with a rubber mouthpiece for recording. During reproduction, the mouthpiece was either left in place for close listening, or could be removed and replaced with a flexible rubber hose and attachment to fit the ear. Note the old-fashioned grease cups mounted on top of the shaft supporting members. Under the feedscrew, on the left side of the shaft, looking at the illustration, may be seen a "half nut" which engaged the feedscrew to drive it laterally during operation. It was disengaged from the feedscrew by the small lever seen directly below the part supporting the "half nut." Many of these replicas are still to be found in this country, and we'd like to locate one for our own personal collection, from which we may draw vital historical information for the preparation of this series.

Edison's search for new things distracted his interest following the development of the tinfoil phonograph, and the great inventor went on to pursue other ideas. Accordingly, it was not until 1887 that his interest in the phonograph was again revived to the point where competition from Bell and Tainter, as well as Berliner, literally forced him back into the phonograph business. It was during the year 1887 that Ezra T. Gilliland manufactured small quantities of Edison machines, Fig. 5, in a small shop on Bloomfield Avenue, Bloomfield, New Jersey. This phonograph was designed for the wax cylinder records and was driven by a hand-made electric motor and powered



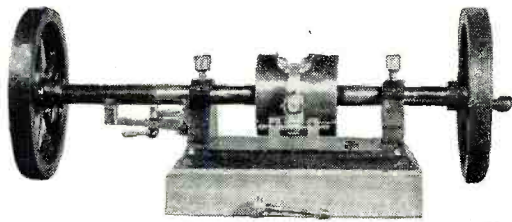

Fig. 4. About 600 of this model were made to demonstrate Edison's invention.

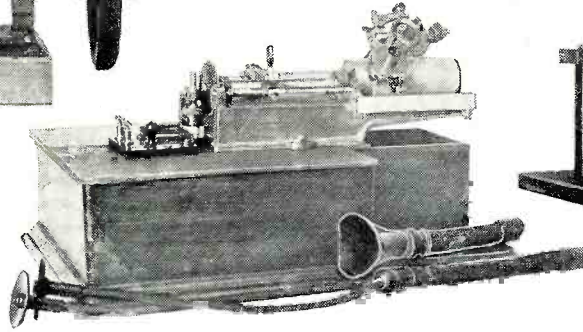

Fig. 5. A two-volt wet cell powered this early cylinder phonograph.

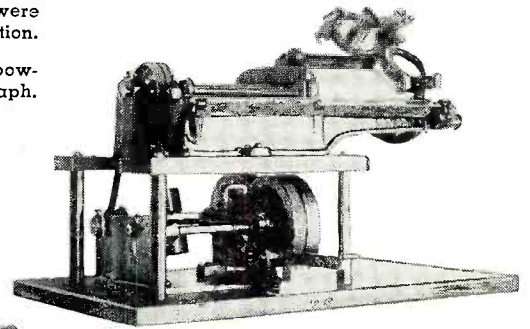

Fig. 6. The first "treadle phonograph" of Edison, Circa 1888.

By  
**OLIVER READ**

Editor  
RADIO & TELEVISION NEWS

and  
**JAMES RILEY**

by means of a wet cell. A tapered friction wheel was mounted directly to the shaft of the motor, resulting in a right-angle drive to a rubber-tired wheel on the shaft comprising the feedscrew and the mandrel upon which the wax cylinder was mounted. The feedscrew was a separate assembly and was coupled to the drive shaft by means of belt and pulley. This phonograph used Edison's "spectacle-type" recorder and reproducer. This device employed two separate diaphragm assemblies; one was used for recording, the other for reproduction. The box shown directly beneath the mandrel was to gather shavings of wax from the rotating cylinder when it was being scraped for further use. Note the small scale mounted in front of the cylinder. This was intended to be used for spot reference and as a guide to designate to the operator any particular sounds that appeared on the cylinder. Accessories included those shown on Fig. 5, comprising a speaking tube and a flexible hose which terminated to two rubber tubes and to special ear pieces. This model is now quite rare.

Next in order of development was the "Treadle Phonograph" of Edison, Fig. 6. This model was first produced in 1888. For the most part, this machine was quite similar to its predecessors, the main difference being in the mode of operation. Reference to the illustration shows a hard wood base of solid oak, upon which was mounted a support shelf for the phonograph mechanism. Mounted to the base was a simple treadle device comprising an operating lever which was pumped up and down by hand, which in turn rotated a shaft upon which was mounted two heavy flywheels. Its action was similar to that of a steam locomotive. A governor was coupled to the drive shaft and served to stabilize the rotation. A flat leather belt coupled the driving mechanism to the main shaft of the phonograph, as shown. This model also used Edison's "spectacle-type" recorder-reproducer. Only a few of this model were ever made.

The first foot-powered Edison model was produced in the fall of 1888, Fig. 7, whereby the phonograph is mounted to a foot-treadle stand resembling the old-fashioned sewing machine. As a

(Continued on page 141)

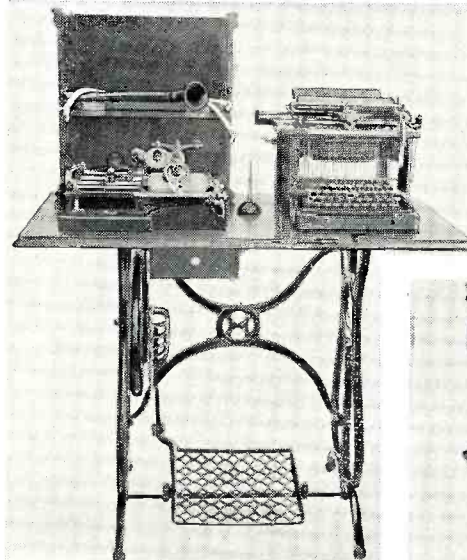

← Fig. 7. Foot-powered treadle phonograph and typewriter of the year 1888.

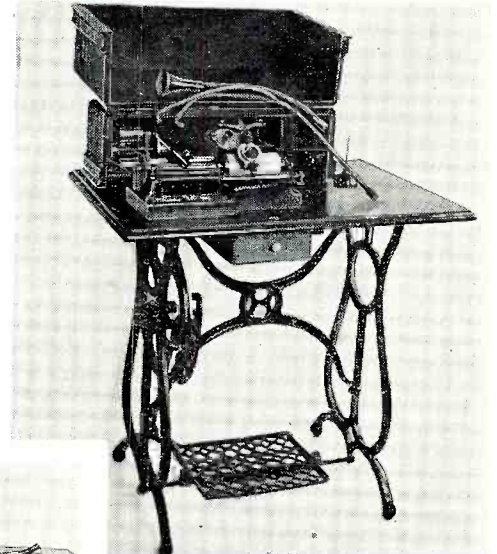

→ Fig. 8. The improved Edison "treadle phonograph" for office dictating.

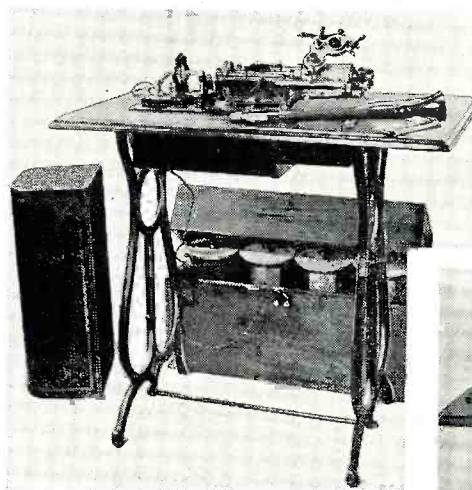

← Fig. 9. Model "Class M" Edison battery phono produced in 1889.

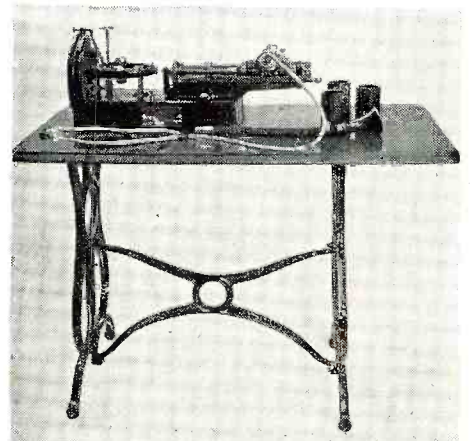

→ Fig. 10. This novel phonograph was operated by water pressure from the house faucet.



# TV Signal Tracing

By **WALTER H. BUCHSBAUM**

Television Consultant

**RADIO & TELEVISION NEWS**

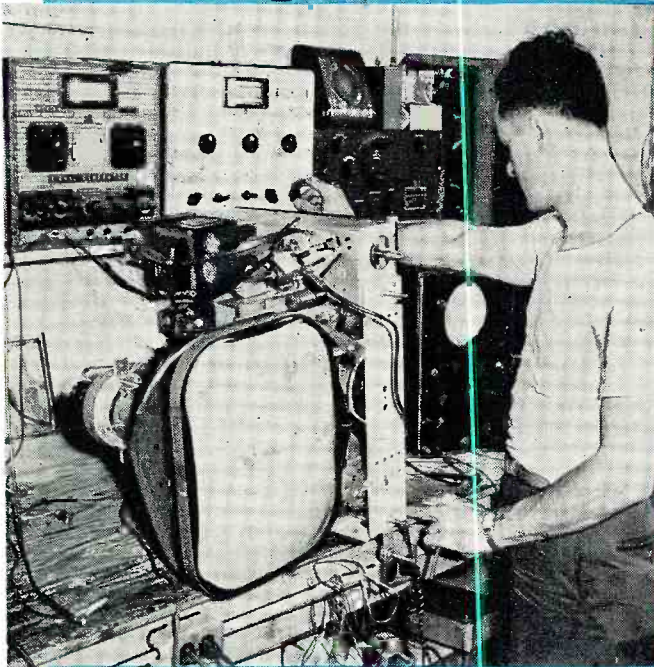

The oscilloscope, a sweep frequency generator, and a crystal diode probe are all the instruments required for signal tracing all circuits of a TV.

## with a Scope

*The oscilloscope is very valuable for TV servicing if properly used. Here is a key to its application.*

**T**HOSE of our readers who have done extensive radio servicing will remember the signal tracer and the technique of tracing a signal from the antenna through to the loudspeaker and so checking the performance of each stage. TV work rarely requires a complete signal tracing, but this same method is invaluable when a really difficult job comes along.

While in radio servicing, a good detector and audio amplifier were sufficient; for the TV signal tracing system, more complex equipment is needed. Most well equipped TV service shops have all the instruments necessary; a signal generator (preferably a sweep frequency generator), a crystal diode probe, a v.t.v.m., and a good oscilloscope. The latter should have good sensitivity. With this equipment and a knowledge of the receiver stage functions almost any defect can be located.

### Typical Defects

It is always helpful to localize a de-

fect to a particular receiver section and this is also true of the signal tracing method. For example, if the defect is found to be a loss of high voltage there is usually no need to consider any but the horizontal sweep section. Similarly, the presence of a stable raster on the picture tube excludes the horizontal and vertical sweep sections as trouble spots. Whenever possible, the defect should be localized by a few voltage checks and some logical reasoning.

The basic block diagram shown in Fig. 1 illustrates the major functions of the various sections. Note the arrows indicating how a defect in one section can affect the performance of another portion. The video amplifier, for example, can cause poor picture quality in conjunction with the i.f. section, but it can also cause poor synchronization together with the sync separator or any of the sweep sections. Hum in the audio section can be due to the power supply, the i.f. section, the video amplifier, or even the ver-

tical sweep section. The power supply can cause defects in any other section as indicated by the three arrows. Simple voltage measurements will usually show up incorrect operating voltages. Where hum seems due to the power supply it appears also in the receiver section which passes this trouble on to the picture.

From the preceding it appears that most troubles can be referred to at least a few receiver sections, which are subject to signal tracing first. There are, however, defects which are not limited to just a few sections and then an over-all signal tracing is indicated. Typical troubles of this type are slow fading in and out of the picture, and intermittent severe distortion of the entire picture. Such defects are hard to describe, but the service technician who has once encountered such a "pumping" or spastic condition is not likely to forget its appearance and the subsequent hard work needed to find the defective part. Rather than take "potshots" at the receiver by replacing first one part and then another, a systematic signal tracing method is the answer.

### Power Supply

Measuring voltages is routine, but often insufficient to show failures which are of the intermittent type. For this reason the power supply should be checked not only for correct voltages, but the scope should be connected to each "B+" bus in turn for a few minutes with the set operating on a station signal. This will show up any variations in voltage as well as excessive hum and modulation of the "B+" by vertical, horizontal, or video signals. Not only the output of the rectifiers, but also the "B+" points at the various filter and decoupling capacitors should be monitored in this manner.

A certain amount of 120 cps hum is inherent in every set and this will appear on the scope as shown in Fig. 3A. The amplitude of this hum is very important. Whenever it exceeds .5 volt peak-to-peak, poor filtering is indicated. If the oscilloscope does not contain a calibrating voltage, the 6.3 volts across the heater of a tube in the TV set can be used as reference, remembering that this appears as 18 volts peak-to-peak on the scope.

When some other signal is visible, in addition to the 120 cps hum, try to bypass some of the electrolytics with a .1  $\mu$ fd. paper capacitor. Occasionally, the output stage of the audio section is part of the "B+" voltage divider and

**RADIO & TELEVISION NEWS**



a defect in that circuit causes sound modulation of the "B+" voltage. Again, the oscilloscope picture will clearly show this defect and permit tracing it right to the defective component.

The scope picture in Fig. 3B shows a typical instance where the vertical sweep signal rides through to some extent on the "B+". In the receiver this causes an audible buzz as well as uneven shading of the picture. Such a buzz cannot be eliminated by alignment of the i.f. or sound discriminator, nor does the power supply filtering take care of it. The real culprit here was an open 10  $\mu$ fd. capacitor connected in the "B+" return of the vertical output transformer. By signal tracing the hum on the "B+" line it became apparent that it was most pronounced on that part of the "B+" distribution system which goes directly to the vertical output circuit.

It is difficult to illustrate the appearance of a "B+" "jumping" such as may be caused by intermittent breakdown in some component. Fig. 3C was obtained by taking multiple exposures of the oscilloscope picture indicating this effect. Here, the ripple on the "B+" line was about 1 volt. At times, the jump in "B+" level is on the order of several volts. This defect resulted in a variation in brightness as well as size of the TV picture, and would occur at about 1 second intervals during receiver warmup. After about 10 minutes operation, the picture became steady and no defect was apparent.

Signal tracing with the scope showed that "B+" points which had their own decoupling network were not affected by the "jumping." Connecting the scope to the cathode of the horizontal output tube showed that the current through that tube varied greatly in step with the "jumping." Next, the scope was connected to the screen grid of this tube. Here the "jumping" was extremely severe.

Removing the horizontal output tube from the chassis did not cure the variations in the "B+" line, and at the screen grid terminal of this tube socket the scope picture "jumped" as violently as before. Disconnecting the .25  $\mu$ fd. screen bypass capacitor cured the defect immediately. Although this capacitor measured correctly on a capacitor tester, the high screen voltage apparently caused internal arcing during warmup. Replacement with a new capacitor completed this repair job.

### Signal Circuits

Many service technicians feel that the scope cannot be used to troubleshoot the r.f. and i.f. sections. Actually, the oscilloscope is ideally suited for carefully checking each of these stages for gain, alignment, stability, and interference. A sweep frequency generator and a crystal diode probe are needed as well as the scope. The generator is used to supply a signal strong enough for the crystal probe to detect, since station signals may not have enough amplitude in the r.f. and first

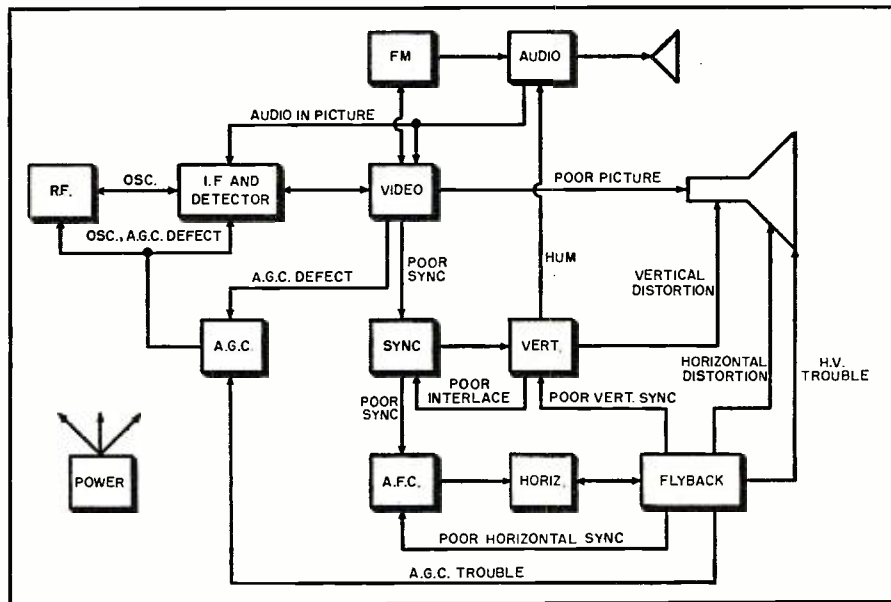

Fig. 1. Block diagram of the various sections of a TV receiver showing the way in which a defect in one section can affect the operation of one or more other sections.

i.f. stages to be visible on the scope. In most of the tests to be outlined the sweep generator is tuned to some unused channel and connected to the antenna terminals.

Signal tracing the r.f. and i.f. stages is indicated when either the picture or sound appear defective and no trouble has been found in the video or audio sections. In other words, in cases of poor picture resolution, smearing, weak picture, etc., the video amplifier is traced through first and then the r.f. and i.f. sections are checked.

The first test will not require the sweep generator. A station signal is observed on the picture tube and at the same time the scope is connected to the output of the video detector. This may show hum or other variations such as interference (which would also appear on the TV picture tube). Try replacing i.f. tubes, the r.f. amplifier tube in the tuner, and finally the oscillator tube. Temporarily connect a filter capacitor across the a.g.c. bus, but be sure that the positive terminal of the electrolytic goes to ground and the negative terminal to the a.g.c. bias point. Another quick check involves shunting a .01  $\mu$ fd. capacitor from each i.f. heater to ground to eliminate any regeneration in that circuit.

Next, check on the over-all r.f.-i.f. frequency response. Fig. 2 is a typical response curve which, while not too bad, is also not quite correct. The peak near the sound i.f. gives extra gain to the high-frequency portions of the picture and, in conjunction with excessive

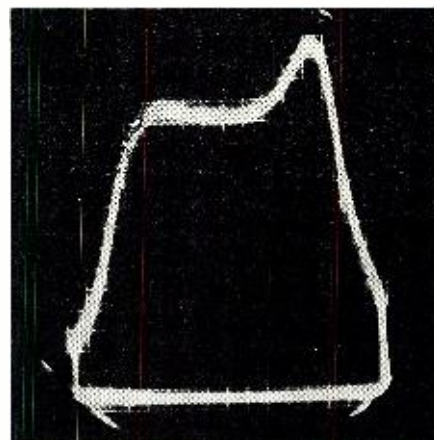
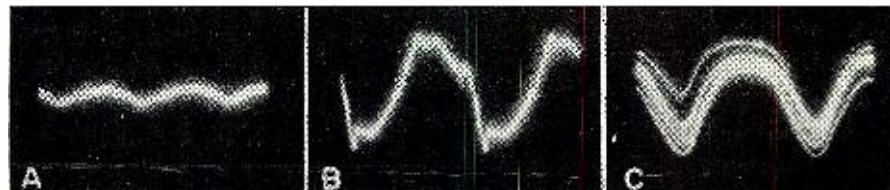

Fig. 2. Typical response curve of a TV i.f. strip. Note the peak on the right which can result in ringing.

peaking in the video stages this might appear as ringing or a sharply defined ghost image.

If the response curve appears particularly good, this may be due to overloading of some i.f. stage. Reduce the amplitude of the sweep generator output until the scope presentation appears almost submerged in noise. Then increase the sweep generator output gradually, observing the response curve and checking the a.g.c. bias with the v.t.v.m. If the receiver uses keyed a.g.c. the bias must be supplied by a battery. For about 3 volts of bias the response curve should be undistorted. When the bias voltage reaches 5 to 6 volts, no overloading should appear.

Fig. 3. (A) shows the trace on a scope for 120 cps hum; (B) shows a case of excessive "B+" ripple with superimposed vertical sweep signals; (C) shows "B+" jitter.





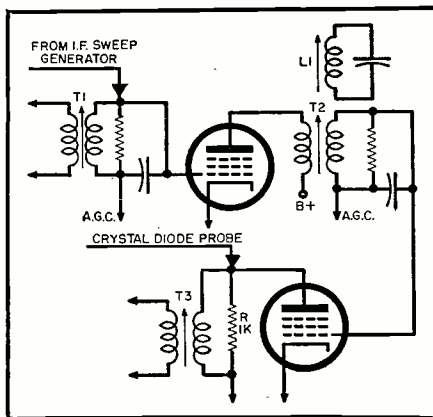

Fig. 4. To check the gain of an i.f. stage and its frequency response with an oscilloscope, connect the sweep generator and scope probe as shown.

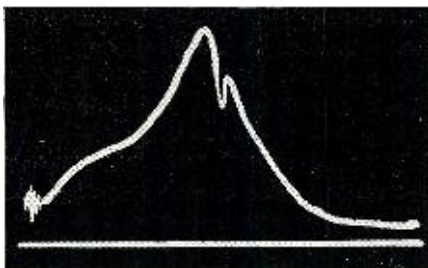

Fig. 5. Typical response of a single i.f. stage of the type shown in Fig. 4.

If the response curve appears to overload irrespective of bias, then one of the first i.f. stages or the r.f. amplifier and mixer are not getting proper bias on their control grids. A conclusive check of the a.g.c. efficiency can be made by comparing the bias voltage required from the battery to avoid overloading with that obtained on a station signal which shows the effects of overloading. When the set has an a.g.c. control, the setting of that potentiometer should be carefully checked to permit reception of the weakest signal and avoid overloading on the strongest signals. Regeneration, hum, or other defects due to the a.g.c. will also be localized by the substitution of battery bias and careful comparison with station signals.

In sets where the i.f. gain appears questionable or intermittent and tubes have been replaced, a stage-by-stage test is indicated. First check the over-

all frequency response. Then use a crystal diode probe and connect it to the output of the last i.f. stage and observe the scope pattern. Moving the probe to the grid of that i.f. stage should result in a lower amplitude and differently peaked scope trace.

If one particular stage is suspected, connect the sweep generator to the grid of that stage, switching its selector knob to the i.f. band. Fig. 4 shows where to connect the sweep generator to the grid of a typical i.f. stage and also how the crystal diode probe is connected across the load of the following i.f. stage. To reduce the effect of the second stage, a 1000-ohm resistor,  $R$ , is temporarily connected across the tuned output circuit of that stage, as shown in Fig. 4. By this method, the response curve of only one stage is observed and gain measurements as well as a check of the tuned network is possible.

A typical single stage response curve is shown in Fig. 5. The sharp dip in the curve is due to a tuned trap circuit similar to  $L_1$  shown in Fig. 4. The lower, secondary peak could be due to the output network ( $T_2$ ) across which the 1000-ohm resistor is connected. At the extreme left, the marker frequency signal is just visible.

### Sweep Circuits

Every active service technician is familiar with the adjustment of the "synchronizer" a.f.c. circuit by means of the scope. Similarly, the waveshapes encountered in the vertical sweep section are familiar because most circuit diagrams illustrate their correct form.

There are variations in these waveforms which indicate certain defects and are useful in troubleshooting. A good example is the two horizontal sweep signals shown in Figs. 6A and 6B. The waveform in Fig. 6A is the normal one at the grid of the horizontal output tube of a TV receiver using a conventional ferrite core flyback circuit. Fig. 6B shows the same waveform but with reduced amplitude and a little wiggle at the start of the sawtooth. The picture may appear fairly normal on strong signals, but on weaker stations there will be some vertical lines at the left of the screen. Changing tubes may not clear up this defect and tracing the signal through to the

plate and cathode of the damping diode may reveal that the ringing is strongest at the "hot" side of the deflection yoke. (In making these checks it is necessary to use a high-voltage probe with the scope since the pulse at the deflection yoke may go up to 5000 volts in some sets.) Usually, this type of defect is due to crosstalk, ringing, or poor damping in the deflection yoke. The 56  $\mu\text{fd.}$  (or thereabout) capacitor and any resistor in the yoke circuit should be replaced before the deflection yoke itself is replaced.

Another use for the scope is to check the effect of the vertical sweep on the horizontal and *vice versa*. Horizontal hum due to either the power supply or the vertical sweep can be simply detected by setting the scope for about 30 cps and checking the various points in the horizontal a.f.c. and sweep circuits for the presence of 60 cps signals.

Poor interlace of the vertical lines is often due to loss of the correct vertical pulse. This can be checked by connecting the scope to the vertical integrating network and observing two successive synchronizing pulses. They should differ slightly in spacing. Often this is not apparent because the vertical sweep signal rides through and obliterates the serrated timing pulses which make up the vertical sync pulse. Occasionally, radiation from the horizontal flyback supply or an open capacitor in the integrating network causes the horizontal signals to obliterate the serrated pulses and produce poor interlace. All these troublesome service jobs are best handled by using the scope for signal tracing.

The synchronizing pulses, video signal, and blanking pulses can all be traced with the scope, and most circuit diagrams show the correct waveshapes. "Jitter" or other forms of instability in the video section can easily be spotted with the scope by using the 60 or 30 cps sweep setting. To observe overloading or clipping of the video signal, the scope should be set for about 15 kc. to show the waveform corresponding to a single line. Noise interference and any noise clipping action, as well as the operation of the d.c. restorer circuit may also be observed in this manner.

In the audio section, to trace distortion, a sine wave or pulse from a signal generator is injected at the input and traced with a scope through to the audio output transformer secondary. Feedback, microphonics, and hum can be traced with the scope and localized by removing tubes and disconnecting parts until the defective one is identified.

The oscilloscope permits us to "look inside" the circuitry and follow each signal through every component and tube. Whether a sweep or video signal is traced through the receiver, the changes it undergoes become apparent on the scope. Thorough troubleshooting of a TV set for hidden defects is usually unnecessary, but when a difficult service job is encountered, the signal tracing method is invaluable.

Fig. 6. Horizontal waveforms at the input to horizontal output amplifier. (A) shows the correct waveform, (B) shows an attenuated sweep signal with incorrect shape.

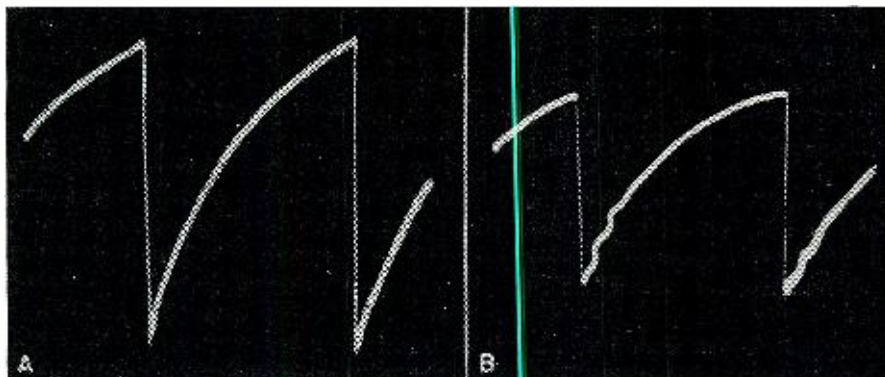



# Tubeless Scope Calibrator

By EDWIN BOHR

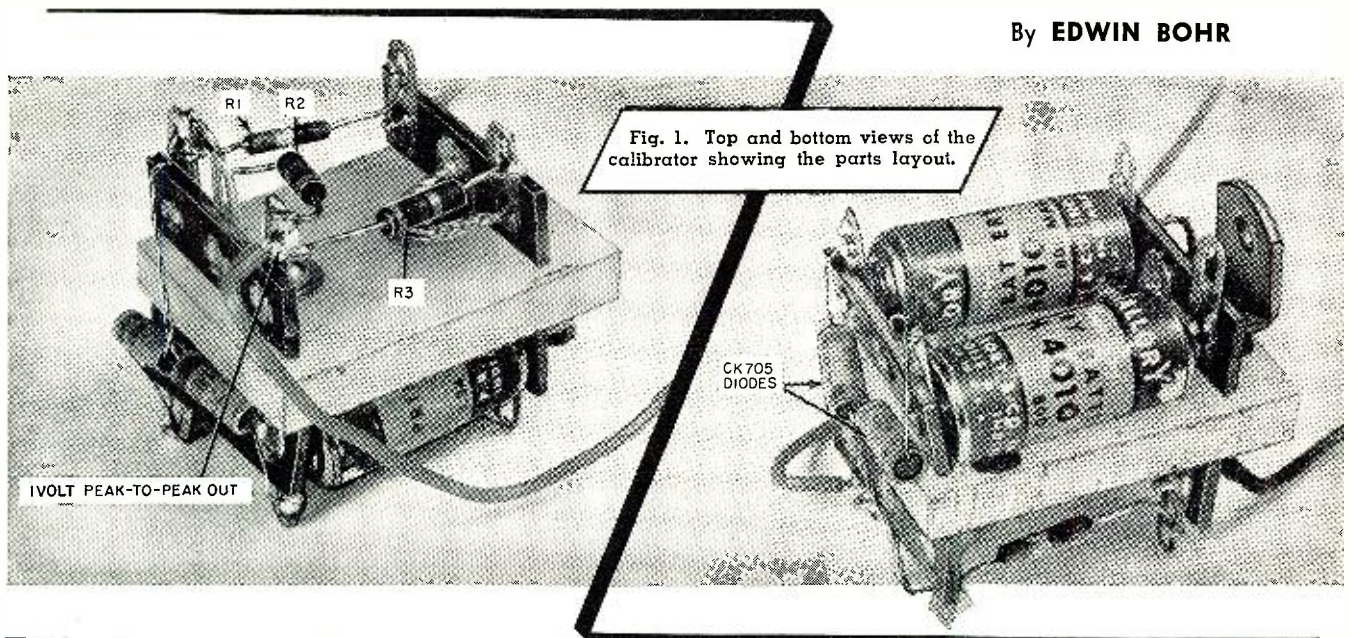

Fig. 1. Top and bottom views of the calibrator showing the parts layout.

TWO dollars and seventy-five cents will buy all the parts to build the oscilloscope voltage calibrator shown in Fig. 1. The calibrator can be added to kit-built or other scopes that do not feature some sort of built-in calibration source.

The unit described in this article furnishes a clipped sine wave of accurate peak-to-peak amplitude. This clipped sine wave, when fed into the oscilloscope, provides a means for calibrating the grid on the face of the scope.

Since the calibrator uses no vacuum tubes, essentially no extra power drain is placed on the scope. There is enough extra room inside almost any scope housing for the calibrator which measures only  $1\frac{3}{4} \times 1\frac{1}{4} \times 1\frac{1}{2}$  inches.

Mercury cells establish the clipping level of two germanium diodes biased in their reverse directions, see Fig. 2. A six-volt r.m.s. signal from the heater winding of the scope power transformer is fed through  $R_1$  to the diodes. The two diodes can not conduct until the a.c. signal exceeds the backward bias from the mercury cells. When the a.c. signal from the heater winding reaches the bias level of the diodes, the diodes begin to conduct and clamp the output voltage to this level.

The mercury cell, unlike ordinary dry cells, maintains a constant potential, varying only a few millivolts, over a wide range of age and temperature conditions. As a voltage reference, the mercury cell is infinitely superior to the gaseous regulator tube—such as the 0A2, for example—ordinarily used in calibrators.

Germanium diodes make the low-working-voltage calibrator circuit possible. Vacuum tube diodes, because they produce an e.m.f. of their own (contact potential), are not suitable

for this circuit. This contact potential reaches a volt in high impedance circuits and its value is very unstable. Calibrator circuits using vacuum tubes must operate at a hundred volts or more. This way the contact potential is reduced to a very small percentage of the total signal. Fortunately, germanium diodes do not display these particular deleterious effects. This permits the design of low voltage circuits.

Basically, the calibrator circuit of Fig. 2 is very accurate. The diodes introduce the greatest error in the peak-to-peak output, since the diodes are not perfect rectifiers, nor perfectly uniform in characteristics. Lest the magnitude of this error be misunderstood, it can be kept within .1 volt.

The e.m.f. of the mercury cell is 1.345 volts. So, the clipper peak-to-peak output is twice this value or 2.7 volts. A divider,  $R_3$  and  $R_2$ , attenuates the clipped wave to one volt peak-to-peak at point "B." The ratio of these resistors should be  $R_3 : R_2 = 1 : 1.7$ . The values in the parts list are not exactly in this ratio because the closest commercial five per-cent resistor values

were used in construction. If one per-cent resistors are chosen, for greater accuracy, they should follow this ratio.

## Construction

A small piece of plastic, one-quarter inch thick, is the chassis for the calibrator. An angle bracket grounds and mounts the unit to the scope chassis or front panel. Two terminal strips act as clamps for the mercury cells. The terminal strips are spaced slightly closer than the length of the mercury cells, providing a friction fit. The outside case of the mercury cell is *positive* and the *center button is negative*. Two small dots of red lacquer on the plastic indicate which way the mercury cells should be mounted.

The CK705 is a general purpose diode very similar to and replaceable with the 1N34. The CK705 is smaller than the 1N34 and hermetically sealed. Also, its leads do not conduct heat into the diode as fast as some other types. But, it is still advisable when soldering these into the circuit to carry away excess heat by grasping the diode lead

(Continued on page 110)

Fig. 2. Schematic diagram and parts list for the complete scope calibrator. The output at point "A" is 2.7 volts; at point "B", it is 1 volt.

- $R_1$ —100,000 ohm,  $\frac{1}{2}$  w. res.
- $R_2$ —200,000 ohm,  $\frac{1}{2}$  w. res.  $\pm 5\%$  (see text)
- $R_3$ —120,000 ohm,  $\frac{1}{2}$  w. res.  $\pm 5\%$  (see text)
- $B_1, B_2$ —Mercury cell (Mallory RM4010)
- $CR_1, CR_2$ —Germanium diode (Raytheon CK705 or equiv.)

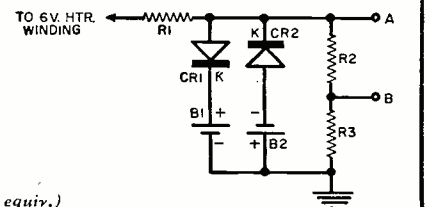



# A TRANSISTORIZED PULSE GENERATOR

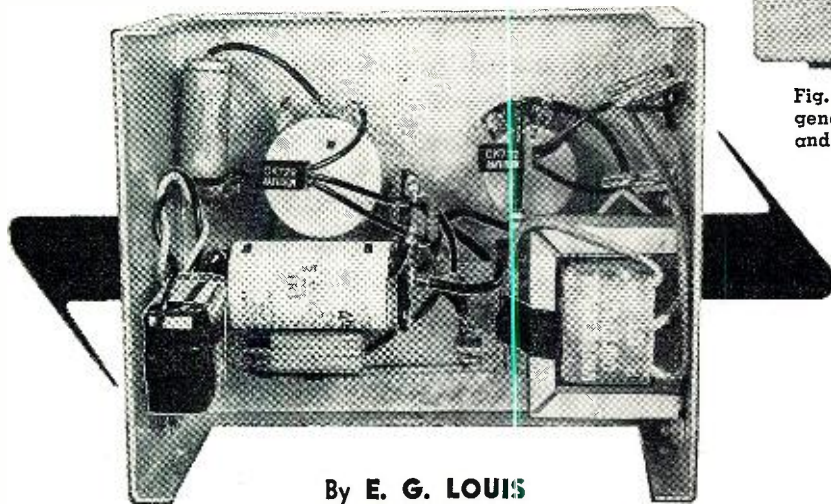

By E. G. LOUIS

*Build this pocket-sized test instrument which is useful in a wide variety of lab and service tasks.*

**A**S NEW laboratory techniques are worked out and new circuits developed, the need for specialized test equipment rapidly changes so that "special" equipment often becomes "standard." For example, pulse generators, once found only in the larger laboratories, are gradually coming to be considered as "standard" pieces of test equipment for all labs. In some cases, pulse generators are used as much as oscilloscopes and v.t.v.m.'s, "standard" equipment items of long standing.

Most pulse generators are characterized by their large physical size and their voracious appetite for electrical power.

Not so the instrument shown in Fig. 1. Although delivering either positive- or negative-going pulses over a wide frequency range (100 to 6000 pulses-per-second . . . other ranges are easily obtained), and with good output amplitude (12-15 volts peak across a 10,000 ohm load), the over-all case size is only 3"x4"x5" and the power requirements are so small that it is practical to power it with a self-contained hearing-aid type battery!

In addition to its small size and low power requirements, the instrument shown has many other advantages. Highly efficient, it doesn't generate large quantities of surplus heat to in-

crease the discomfort in a crowded lab or work shop. Light in weight and quite rugged, the instrument is ideally suited for portable and field work. It may, literally, be "slipped in an overcoat pocket."

The instrument shown also has the advantage of requiring neither "warm-up" time nor "stand-by" power. It is ready to use as soon as the power switch is thrown "on."

All these features have been made possible by designing the unit around the highly efficient Raytheon type CK-722 (*p-n-p*) junction transistors.

Standard, commercially available components are used throughout and the circuit is sufficiently simple so that the average technician should have little or no difficulty in building a similar or duplicate unit in one or two days.

## Circuit Description

Basically, this transistorized pulse generator consists of one transistor connected as a blocking oscillator followed by a second transistor serving both as a clipper and as a buffer-amplifier.

Referring to the schematic diagram of Fig. 2, the first CK722 transistor is connected in a *grounded emitter* blocking oscillator circuit, with transformer  $T_1$  providing the necessary energy feedback to start and sustain oscillation.

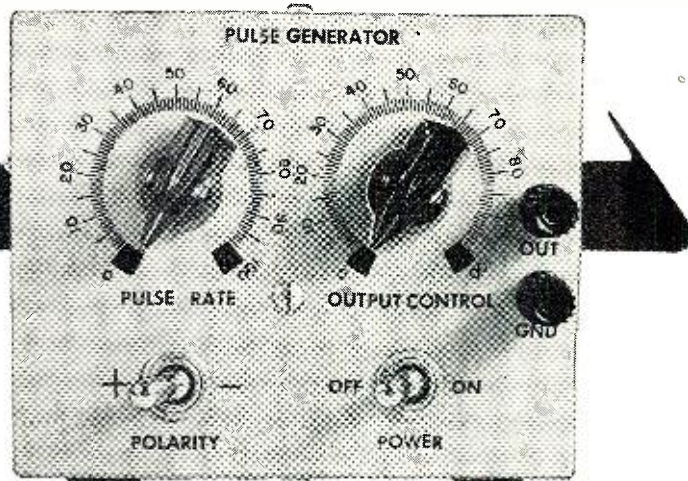

Fig. 1. Two views of the author's home-built pulse generator. It is built into a 3"x4"x5" case and is powered by one hearing-aid type battery.

A stepdown turns ratio is provided to match the high collector circuit impedance to the low input impedance of the base-emitter circuit.

In operation, the "blocking" action occurs through the rapid charge of  $C_1$  through the base-emitter circuit of the transistor and the secondary of  $T_1$ , and the gradual discharge of this capacitor through  $R_1$  and  $R_2$ . The blocking rate is determined essentially by the *RC* time constant of the circuit made up of  $C_1$ ,  $R_1$ , and  $R_2$ .

By making  $R_1$  adjustable, the circuit time constant and, hence, the blocking rate, can be changed.  $R_1$  thus serves as the "Pulse Rate" control.

$R_2$  is provided to limit the maximum blocking frequency and to protect the transistor from overload.

A signal is obtained from the blocking oscillator stage by means of a tap on  $T_1$  and is applied, through coupling capacitor  $C_2$ , to the base of the second transistor, which serves to shape and amplify it.

A s.p.d.t. toggle switch ( $S_1$ ) is provided to change the bias current of the second CK722 stage, and thus its mode of operation. When this switch is "open," the stage operates with "zero bias," since the base resistor,  $R_4$ , is returned directly to the emitter of the transistor.

Under these conditions, the stage acts to limit or "clip" the positive-going and to amplify and shape the negative-going portions of the applied signal. The amplified signal appears across load resistor  $R_5$ , but with positive polarity, due to the phase reversal of the stage.

By using a potentiometer for  $R_5$ , this resistor serves not only as the load resistor for the output clipper-amplifier, but also as the "Output" level control. The output signal is obtained through blocking capacitor  $C_3$ , with its amplitude dependent on the setting of  $R_5$ .

When  $S_1$  is thrown to its "closed" position,  $R_3$  is connected between the base of the transistor and the negative side of the power source, thus permitting a heavy base "bias" current to flow. This radical shift in "bias," in turn, modifies the operating character-



istics of the stage so that the negative-going portions of the applied signal are clipped and the positive-going portions are shaped and amplified.

This results in pulses of negative polarity appearing across load resistor  $R_5$ .  $S_1$  thus serves as the pulse "Polarity" switch.

Power is supplied by a hearing-aid type battery,  $B_1$ , controlled by a s.p.s.t. toggle switch,  $S_2$ , serving as the "Power" switch. Capacitor  $C_4$  is provided to insure a low impedance across the power source.

**Output Signal Waveforms:** The waveform of the output pulses obtained from the author's model are given in Fig. 3. The signals obtained from another unit should appear similar to these, but may not be exact duplicates.

A low-frequency (approximately 200 pulses-per-second) positive-going pulse is shown in Fig. 3A, and a high frequency (about 6000 pulses-per-second) positive-going pulse in Fig. 3B.

As can be readily observed by comparing these two illustrations, the pulse-width remains relatively constant (it appears narrower in Fig. 3A because of the lower repetition rate). The pulse width depends primarily on the characteristics of the transformer ( $T_1$ ) in the blocking oscillator stage.

When the "Polarity" switch,  $S_1$ , is thrown so that negative-going output pulses are obtained, the shaping action of the output CK722 stage is not quite as good, so that the negative-going pulses are not quite as sharp as the positive-going pulses. Nonetheless, they are quite satisfactory for most practical work.

Typical high-frequency negative-going pulses (about 6000 pulses-per-second) are illustrated in Fig. 3C.

The maximum amplitude of the output pulses is approximately equal to the voltage of the power supply battery ( $B_1$ ) because the output CK722 stage is driven over such extremely wide limits. On one peak the collector current is reduced to virtually zero, while on the other peak, the collector current reaches the maximum possible with the supply voltage and load resistor ( $R_5$ ) used.

### Construction Hints

The exterior and interior views (see Fig. 1) of the author's model are sufficient to indicate the general layout and parts placement. This layout need not be followed exactly, however, although standard, good wiring practice should be used.

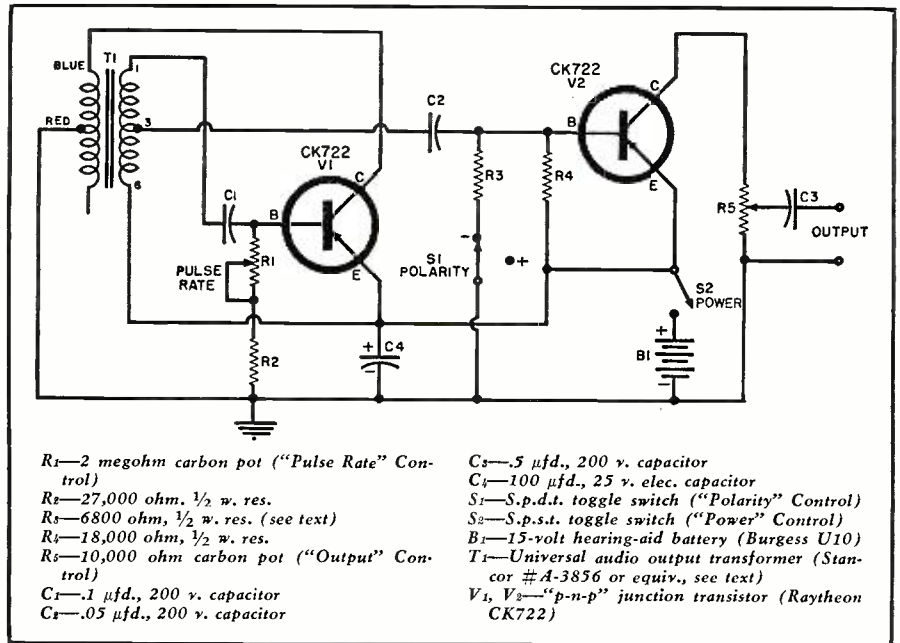

Fig. 2. Complete schematic of pulse generator. It uses standard junction transistors.

Although the model was assembled in a standard 3"x4"x5" metal box, either a larger or smaller case may be used. If a smaller case is employed, the wiring will require somewhat greater care.

All controls and switches in the model were labeled using commercially available black decals protected, after application, by three coats of clear plastic. The plastic coating is easily applied with a standard "spray can."

The battery is held in place by a small "Z" bracket, with its connections made simply by soldering leads to its brass end terminals. A certain amount of care must be exercised when doing this to avoid overheating and shortening the life of the battery.

Scotch electrical tape was used to insulate the exposed battery terminals after the connecting leads were soldered in place.

Another builder might prefer to devise and construct a small "clip" or "socket" for the battery, so that it would not be necessary to use a soldering iron to remove or replace the unit.

As is readily observed in Fig. 1, the author installed the transistors in the model by simply soldering them in place. Should the prospective builder decide to follow a similar course, he should exercise special care to avoid accidentally overheating and damaging these components.

Transistors are especially sensitive

to heat damage. Where they are to be soldered in place, the leads should not be cut too short, and the actual soldering should be done as quickly as possible, using a well-tinned and quite hot iron.

An alternative is to provide sockets for the transistors. Commercially available 5-pin subminiature tube sockets may be used for the CK722. Only three of the pins are required.

The primary connections of transformer  $T_1$  are identified by color coded leads, while the secondary connections are identified by numbered terminals. The proper connections for the Stancor transformer used by the author are indicated in Fig. 2.

**Parts Substitutions:** A number of parts substitutions is permissible in order to change the operating characteristics of the transistorized pulse generator. We will discuss these later under "Circuit Modifications." However, in addition to these component changes, a number of other parts may be changed without modifying the basic circuit.

As mentioned earlier, either a larger or a slightly smaller case may be used without difficulty. In some instances, the builder may wish to wire the pulse generator into an existing piece of equipment.

Slide or rotary switches may be substituted for the toggle switches used as

(Continued on page 124)

Fig. 3. Waveform of output pulses obtained from the author's model. (A) Low-frequency (200 pps) positive-going pulse. (B) high-frequency (6000 pps) positive-going pulse, and (C) high-frequency, negative-going pulse (6000 pps).

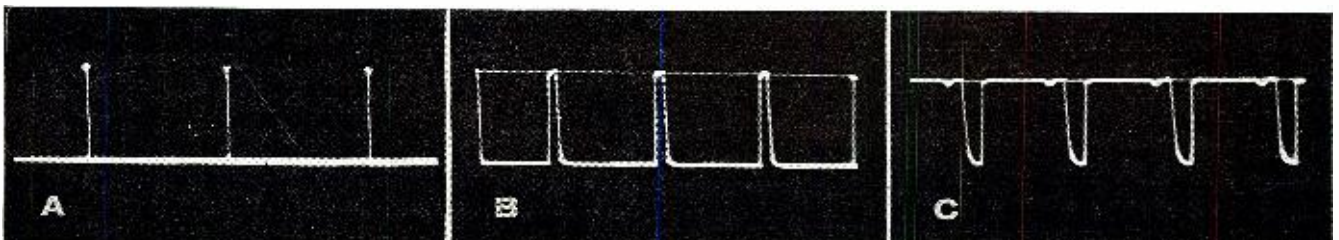





# TAPE RECORDING

By HERMAN BURSTEIN

## Part 5. Equalizing circuits play an important role in providing high signal-to-noise ratio and low distortion.

**T**HUS far in this series, we have discussed the various elements of a tape recorder, record and playback losses, and the effects of bias current. We will now take up the all-important problem of equalization.

The record-playback response of a combination head or of a pair of heads, as illustrated in Fig. 1, may be equalized for essentially flat reproduction over most or all of the audio range by relatively simple circuits in the record and playback preamplifiers. But these circuits can take many forms with respect to location and frequency characteristics. In order to achieve a high signal-to-noise ratio and low distortion, which are just as important as wide frequency range, equalizing circuits must be determined with care, for there are many factors to be considered.

To make clear the factors and problems involved in equalization, this and the final article deal with:

1. Conflict among performance requirements
2. Optimum location of equalization circuits
3. Basic pattern of equalization
4. Example of equalization in an actual recorder
5. Maximum permissible record boost
6. Optimum recorded induction
7. The need for standard equalization

1. *Conflict Among Performance Requirements:* The requirements of wide frequency response, low distortion, and high signal-to-noise ratio are in conflict with each other, so that each can be obtained only at the expense of the others. Therefore the design of a tape recorder represents a balance among the three rather than a maximization

of any one. The nature of the conflict can be illustrated as follows.

Assume it is desired to extend treble response. One way is to reduce bias current. But this results in greater distortion, unless the maximum permissible recording level, as indicated by the vu meter or tuning eye, is reduced, which means, in turn, a lower signal-to-noise ratio.

Assume it is desired to reduce distortion. This can be done by increasing bias current, but only at the cost of attenuated treble response. Or lower distortion can be had by reducing maximum permissible recording level, which means a lower signal-to-noise ratio.

Assume it is desired to increase the signal-to-noise ratio. Maximum permissible recording level can be raised, but this entails more distortion. To avoid increased distortion, bias current can be increased, but this impairs treble response.

The higher the tape speed, the more satisfactory and simple is the resolution of the conflict among performance requirements. As previously indicated; treble losses are largely related to wavelength, diminishing as wavelength increases. Higher tape speed means longer wavelength for any given frequency, so that treble losses become smaller. Therefore it is possible to use greater values of bias current at high speed, resulting in less distortion and/or permitting a higher level of signal to be recorded. Also, the frequency range can be expanded, if desired, because less treble equalization is needed.

2. *Location of Equalization Circuits:* Whether equalization circuits are placed in the record preamplifier or in

the playback preamplifier makes a substantial difference with respect to signal-to-noise ratio and distortion. Circuit location is governed by the following general considerations.

A. *Bass Boost:* At a speed of 7.5 ips, roughly 30 db of bass boost is required, as indicated in Fig. 1.

Putting this much bass in the record preamplifier, considering the amount of audio energy present at low frequencies, would produce a tape with tremendous distortion, unless the signal level is reduced to a point at which the signal-to-noise ratio becomes unacceptably low. Therefore bass equalization must take place primarily in the playback preamplifier.

However, there is a drawback to this principle, its severity depending upon the quality of protection against hum afforded by the tape recorder. In playback, hum pickup by the playback head and hum in the first stage of the preamplifier can be a serious limitation on the signal-to-noise ratio. Consequently in some recorders (along the lines of the NARTB standard for 15 ips recorders, discussed later) the bass boost characteristic levels out at the very low end instead of continuing upward at the rate of 6 db-per-octave throughout the bass range. Correspondingly, if it is desired to maintain flat response all the way down, these machines provide a slight amount of bass boost in the record preamplifier. Such bass boost in record does not raise a serious threat of distortion because, as studies of the distribution of music and speech energy have shown, peak energies at the very low bass end are in most cases appreciably less than peak energies around 400 cps, where they reach a maximum.

B. *Treble Boost:* Treble boost should take place primarily in the record preamplifier because in playback it emphasizes tape hiss and noise in the first playback stage. Inasmuch as peak audio energies in the treble range are substantially lower than peak energies around 400 cps, considerable boost is permissible in record. Also, for a given percentage of distortion, the amount of record current that can be applied to the record head rises somewhat with frequency. However, as previously discussed, treble losses in record are of large magnitude, and there is consequently



a limit to the extent to which these losses can be compensated by treble boost in the record preamplifier. This limit occurs when treble boost begins to overload the tape and cause marked distortion.

**3. Basic Pattern of Equalization:** Fig. 3 shows, in generalized form, how equalization is achieved in a tape recorder.

Line *AB* represents the range over which essentially flat response is achieved.  $F_1$  is the lowest frequency in this range,  $F_3$  is the highest frequency, and  $F_2$  is the "turnover" frequency, namely the point at which the 6 db-per-octave bass boost curve has attained a rise of 3 db.

Line *CD* represents the ideal response of a playback head, either one without any losses or else with such losses compensated in the playback preamplifier. This response assumes that magnetic induction on the tape is the same at all frequencies.

Line *CD* may be viewed as either bass droop or treble rise, depending where turnover point  $F_2$  occurs. In other words, the constant velocity characteristic of the playback head may be used to supply part of the needed treble boost. In the case of recorders operating at 30 ips, this is often unnecessary. But for virtually all recorders operating at lower speeds, the constant velocity characteristic, *CD*, is used to supply a portion of the needed treble boost.

Curve *AE* defines the optimum induction that can be recorded on the tape without exceeding a specified amount of harmonic distortion, usually 1 or 2 per-cent in high grade recorders. Determination of optimum induction will be discussed next month. As the result of the record characteristic *AE* and the playback characteristic *CD*, the playback response without playback equalization is *CB*

Fig. 1. The unequalized record-playback characteristic of a high quality record-playback tape head.

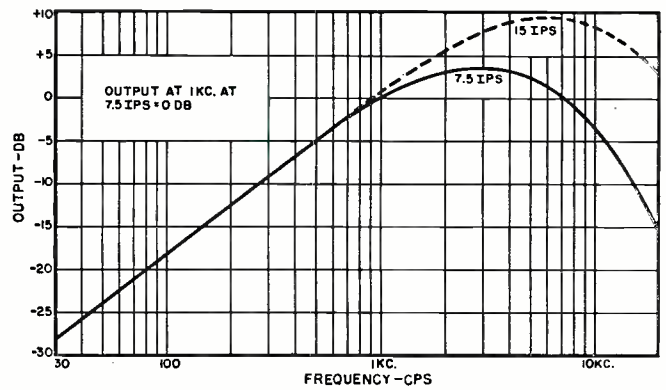

In order to compensate curve *CB* so as to achieve flat response, the complementary curve *FB* is required. In other words, *FB* is the required playback boost.

Since *FB* is determined by *CB*, and since *CB* in turn is determined by *AE*, it can be seen that curve *FB* is determined by curve *AE*. Thus the equalization of a tape recorder can be stated either in terms of the recorded magnetic induction or in terms of the playback bass boost characteristic. The latter is used to define the NARTB equalization standard, as discussed in the following section.

In sum, above the turnover point  $F_2$ , the playback head supplies the portion of treble boost which, for reasons given elsewhere, cannot be provided in the record preamplifier. The playback preamplifier supplies the bass boost which is needed below  $F_2$  because of the playback head's constant velocity characteristic.

**4. Example of Equalization in an Actual Recorder:** The basic pattern of equalization shown in Fig. 3 is of help in clarifying the curves in Fig. 2, which describe the characteristics of a 15 ips tape recorder employing NARTB equalization.

First it is necessary to briefly de-

scribe the NARTB standard, which applies to 15 ips recorders as far as equalization and frequency range are concerned. It provides a specific bass boost curve for the playback preamplifier, indicates that losses in the playback head due to gap length or other factors should be compensated in the playback preamplifier, and then requires that the record preamplifier be equalized for flat response. As explained in the preceding section, the specification of a bass boost curve, in effect, defines how recorded induction should vary with frequency (see curves *FB* and *AE* of Fig. 3).

The NARTB bass boost characteristic is as follows. Using *RC* circuits, the playback preamplifier should develop a curve that has a first turnover point (3 db rise) at 3180 cps, continues to rise at a rate approaching 6 db-per-octave as frequency declines, and levels off at very low frequencies so that at 50 cps (second turnover point) bass boost is 3 db below the maximum amount achieved. The NARTB playback characteristic appears as Curve 4 in Fig. 2. This curve, as mentioned previously, applies to 15 ips recording.

Curve 1 in Fig. 2 shows the record (Continued on page 140)

Fig. 2. Characteristics of a 15 ips recorder with NARTB equalization and flat from 30 to 15,000 cycles/second.

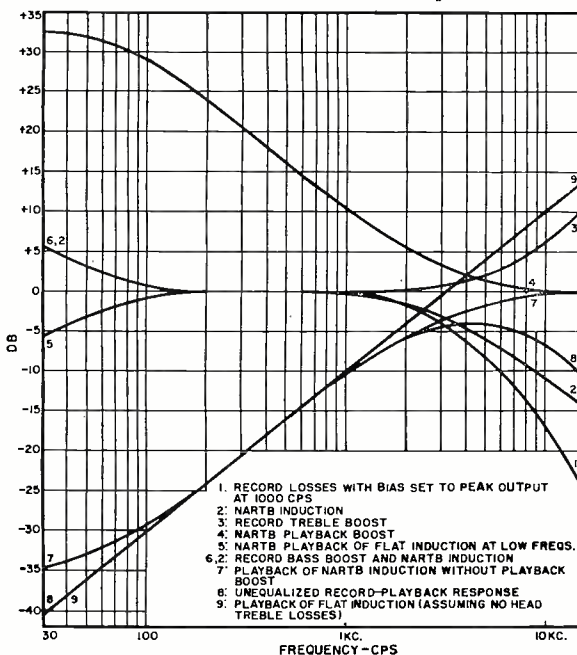
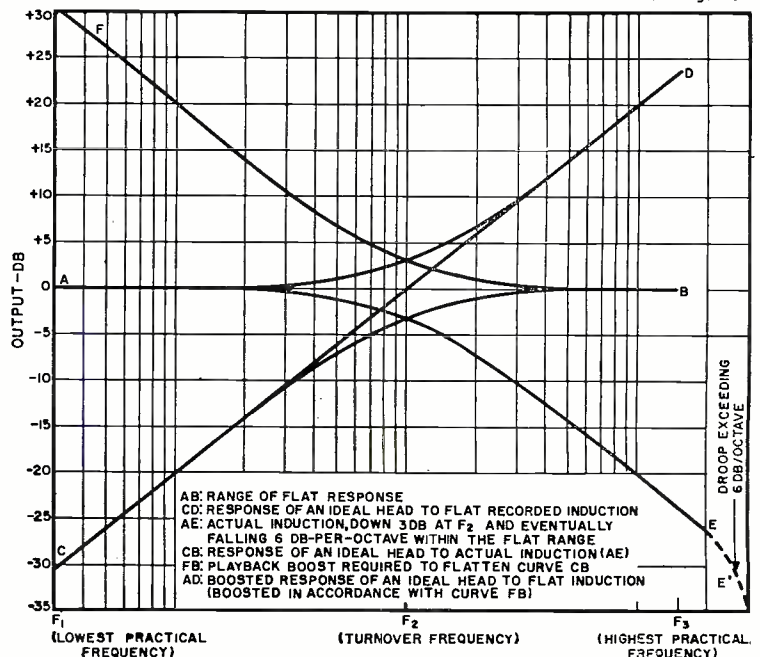

Fig. 3. The basic pattern of equalization for a tape recorder. This graph should be used in conjunction with the characteristic curves of Fig. 2.





# A Transistor R.F. Frequency

Details on a fairly sensitive unit in which one transistor is both the detector and amplifier.

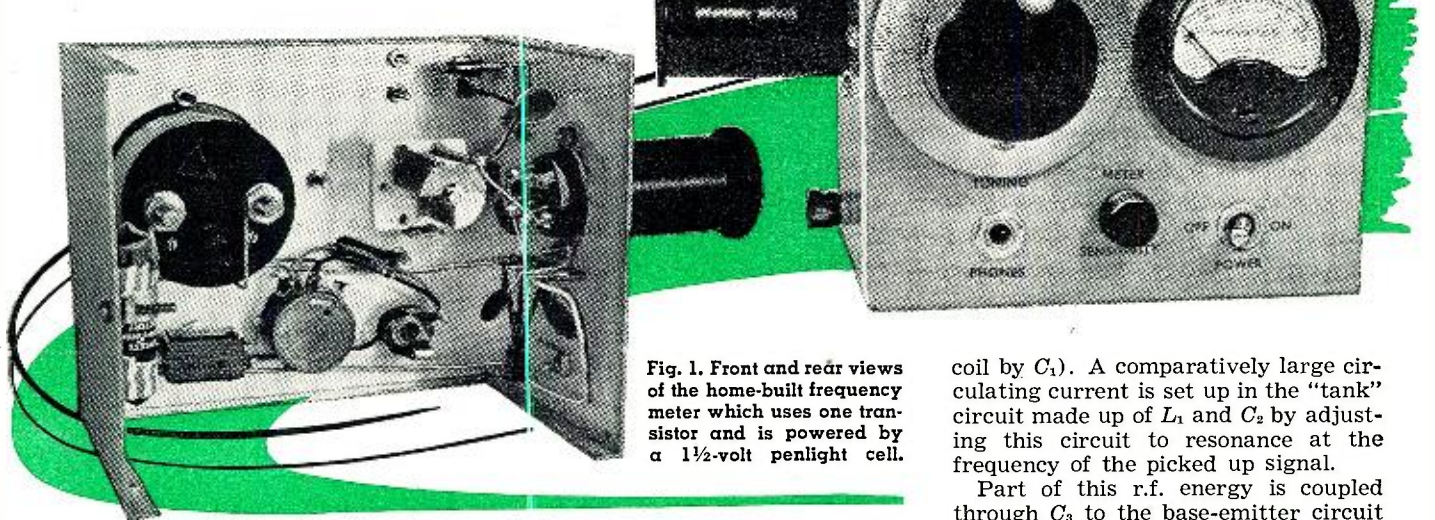

Fig. 1. Front and rear views of the home-built frequency meter which uses one transistor and is powered by a 1½-volt penlight cell.

PROBABLY one of the most popular pieces of test equipment found in the ham shack is the absorption wavemeter or frequency meter. These are generally of two types: the "simple" type consisting of little more than a tuned circuit and a small flashlight bulb, and the "deluxe" type, incorporating a tapped coil, a crystal diode, and a reasonably sensitive meter, together with provision for plugging in a pair of earphones for monitoring purposes.

Of the two types, the first is adequate for many tests around the transmitter and in reasonably close proximity to the various tank coils. However, it lacks the sensitivity needed for many types of measurements.

The second type, while considerably more sensitive, also has disadvantages, in most cases the sensitivity is controlled only by positioning the instrument with respect to the transmitter coils. When used around a reasonably powerful transmitter, needless "banging" of the meter pointer may result. In addition, the meter sensitivity is likely to drop appreciably when phones are plugged into the monitor jack.

Many of these disadvantages have been overcome in the frequency meter illustrated in Fig. 1. This unit has good sensitivity, but its sensitivity is easily adjusted to meet the specific measuring problem encountered. And, quite important, *the meter sensitivity does not change when a pair of earphones is plugged into the phones jack for monitoring.*

This last feature has been made possible by using a Raytheon junction transistor as a combination r.f. detec-

tor and d.c. amplifier. The use of the transistor has also made possible increased sensitivity.

Yet with all these features, the resulting instrument is still light in weight, simple in construction, and compact in size. In fact, the size of the case is determined primarily by the control panel requirements rather than by the internal space requirements of the circuit used.

## Circuit Description

The complete schematic diagram of the transistorized r.f. frequency meter is given in Fig. 2. Referring to this diagram, the "heart" of the instrument is a tuned circuit made up of a tapped plug-in inductance coil,  $L_1$ , and tuning capacitor  $C_2$ .

$C_1$  is a coupling capacitor to the jack for an external "whip" antenna.  $C_3$  is the coupling capacitor to the transistor detector-amplifier circuit. Capacitors  $C_4$  and  $C_5$  serve as r.f. bypasses, while  $C_6$  serves as an audio bypass, bypassing the audio component of the detected and amplified signal around the meter circuit to ground (or to the earphones, when plugged in).

Resistor  $R_1$  is the "base return" resistor for the transistor.  $R_2$ , a potentiometer, is shunted across the meter  $M_1$  and serves as the "meter sensitivity" control. The last resistor used in the circuit,  $R_3$ , serves as a current limiting resistor, to prevent damaging overload of the meter and transistor.

Power is supplied by a penlight cell,  $B_1$ , controlled by toggle switch  $S_1$ .

In operation, r.f. energy is picked up either through inductive coupling to  $L_1$  or through the antenna (coupled to the

coil by  $C_1$ ). A comparatively large circulating current is set up in the "tank" circuit made up of  $L_1$  and  $C_2$  by adjusting this circuit to resonance at the frequency of the picked up signal.

Part of this r.f. energy is coupled through  $C_3$  to the base-emitter circuit of the Raytheon CK722 junction transistor. Rectification occurs here due to the diode action of the base and emitter, setting up a small d.c. base current. If there is any modulation present on the r.f. signal, the transistor base current will contain an a.c. component proportional to this modulation.

The flow of the base current permits a corresponding flow of collector current, although of much greater amplitude. This flow of current takes place over the path including  $S_1$  (now closed),  $J_1$  (and through the phones, if inserted in this jack),  $R_3$ ,  $R_2$ , and the meter (connected in parallel), the collector-emitter circuit of the transistor, and the voltage source  $B_1$ .

Again, if modulation is present on the picked up r.f. signal, this current will also contain an a.c. component proportional to this modulation. The a.c. component is bypassed around  $R_3$ ,  $R_2$ , and  $M_1$  by means of  $C_6$ .

Meter sensitivity is adjusted by means of the shunt rheostat  $R_2$ . As this resistance is reduced in value, more of the collector current is bypassed around the meter and the meter sensitivity is *reduced*. As  $R_2$  is increased in value, less of the collector current flows over this path and more flows through the meter, giving *increased* sensitivity as far as the meter reading is concerned.

Since the impedance of the collector current path is small compared to the internal impedance between the collector and emitter of the transistor, moderate increases in the external impedance have little or no effect on the amount of collector current flow. Therefore, inserting earphones into jack  $J_1$  has virtually no effect on the



# Meter

By **LOUIS E. GARNER, JR.**

meter reading or on circuit sensitivity, even though as much as 2000 ohms is added to the circuit impedance.

Both the antenna connection and the transistor "take-off" point are tapped down on coil  $L_1$  to avoid reducing the "Q" of the tuned circuit and to minimize changes in tuning when the whip antenna is inserted in its jack. The transistor "take-off" point is tapped farther down on the coil than the antenna because of the low input impedance of the transistor. If this tap is made too far towards the "hot" end of the coil, circuit "Q" and sensitivity are reduced.

Since the maximum current drain from the penlight cell seldom exceeds one milliamperere, battery life is virtually equal to the normal "shelf life" of the cell.

## Construction Hints

Construction of the frequency meter shown is reasonably straightforward and no particular difficulties should be experienced by the skilled technician. However, it is essential that good wiring technique be followed.

Although leads in the collector-emitter circuit of the transistor may be made just about as long as desired, lead lengths in the r.f. circuit proper should be kept short and direct. In order to keep the lead to the transistor base short, the author mounted the transistor on a terminal strip right next to the coil socket. Refer to the interior view given in Fig. 1.

The transistor itself may be either wired directly into the circuit by means of its leads, or else a special transistor socket may be provided (use a standard 5-pin subminiature tube socket). If the transistor leads are soldered directly into the circuit, take special pains that these leads are not overheated during the wiring procedure. If possible, do not cut these leads shorter than one inch.

The layout and parts arrangement used by the author are apparent from the interior view given in Fig. 1, but this layout need not be followed exactly. Considerable modification of the circuit arrangement is possible at the discretion of the individual builder. For example, if it is desired to wire the assembly in a smaller case, the large vernier dial used by the author could be omitted and a smaller dial plate and knob used in its place. A smaller meter might be employed.

For the maximum in compactness, while still retaining the basic operating features and controls of the model, the power switch,  $S_1$ , could be combined with the "meter sensitivity" control  $R_2$ ,

and both this control and the phone jack mounted on the side of the case (rather than on the front panel). All of these steps, taken together, would permit assembling the basic circuit into a much smaller case size.

A large cable clamp was used to hold the penlight cell in place in the model, but any one of several alternative methods could be followed by the builder. A large fuse clip, for example, could well be used to hold the battery in place.

## Parts Substitutions

Virtually none of the parts used in constructing the frequency meter is critical and the prospective builder can exercise a wide choice in building his own unit. Let us discuss the individual parts in order.

Coupling capacitor  $C_1$  is not at all critical and any value from 100  $\mu\text{fd.}$  to .01  $\mu\text{fd.}$  should work well here.

The coil,  $L_1$ , and tuning capacitor  $C_2$ , are somewhat critical in that the choice of these components should permit the user to cover the desired range of frequencies. Where more extensive frequency coverage is desired, a number of plug-in coils may be provided. (We will discuss the coil a little later.)

Coupling capacitor  $C_3$  is not critical and good results can be obtained with almost any value from 50  $\mu\text{fd.}$  to 250  $\mu\text{fd.}$  Either a mica or ceramic capacitor may be used here.

Capacitors  $C_4$  and  $C_5$  are also not critical and values from .001  $\mu\text{fd.}$  to .05  $\mu\text{fd.}$  may be used here. Paper, mica, or ceramic types are all suitable.

Audio bypass capacitor  $C_6$  may have any value from 0.1  $\mu\text{fd.}$  up. Although the author used a "metallized" paper type, molded capacitors or conventional waxed tubulars might well be used here.

The resistors required are non-critical.  $R_1$  may have any value from 6800 ohms to 18,000 ohms, although 10,000 to 12,000 ohms seems to be "optimum."  $R_2$  may have a total resistance of from 1500 ohms to 10,000 ohms, and any taper may be used.  $R_3$  may have any value from 470 ohms to 2200 ohms.

Even the battery voltage is not critical, and either a 1.2-volt mercury cell, a 1.5-volt penlight cell (or flashlight battery), a 3-volt dry cell (such as the Burgess type 422), or a 6-volt dry cell might be employed (such as the RCA type VS068 "A" battery).

Other meters may be substituted for the 0-200 microammeter used by the author. The only difference in opera-

tion will be a change in the over-all sensitivity of the instrument. An 0-50 or 0-100 microammeter will permit increased sensitivity, while an 0-500 microammeter or 0-1 milliammeter will give a unit with less sensitivity.

## Coil Winding Data

The coil is wound using standard design procedure as described in the "Radio Amateur's Handbook" or in other standard reference sources. Choose a coil form and wire size suitable for the frequency range to be covered and for the tuning capacitor used.

The exact positions of the two taps are not too critical. However, the tap for the transistor (to which coupling capacitor  $C_3$  is connected) should not be more than one-fifth the total number of turns from the "cold" end of the coil. Actually, a little less than this is preferred. For example, if a total of 100 turns is used, the lower tap should not be more than 20 turns from the grounded end of the coil, and 12 to 15 turns would be preferred.

The antenna tap (to which  $C_1$  is connected) may be from one-quarter to one-third the total number of turns, although the higher the tap is made on the coil, the greater the de-tuning effect when the "whip" antenna is used. However, as the antenna tap is moved "up" on the coil, the pick-up sensitivity of the "whip" is improved. For maximum pick-up, the antenna tap may be omitted entirely and  $C_1$  connected to the "hot" end of the coil. In this case, the de-tuning (when the "whip" antenna is inserted in its jack) is quite severe.

The coil used by the author consists of 72 turns of No. 26 enameled wire on a standard 1 1/4" 4-prong form. Taps are at 13 and 23 turns. Frequency coverage, with the capacitor used, is from 1.2 to 4.0 mc.

## Operation and Calibration

Before the completed instrument can be used properly as a frequency meter, it should be accurately calibrated. Calibration is most easily accomplished using a grid dip meter or a signal generator with good output.

First, check the output signal of the grid dip meter (or signal generator) by coupling it to a communications receiver and "zero-beating" against known broadcast stations, short-wave stations, or WWV. Once the accuracy of the grid dip meter is known, it can be coupled to the transistorized r.f. fre-

(Continued on page 103)

Fig. 2. Schematic of r.f. frequency meter. See text for possible parts substitutions.

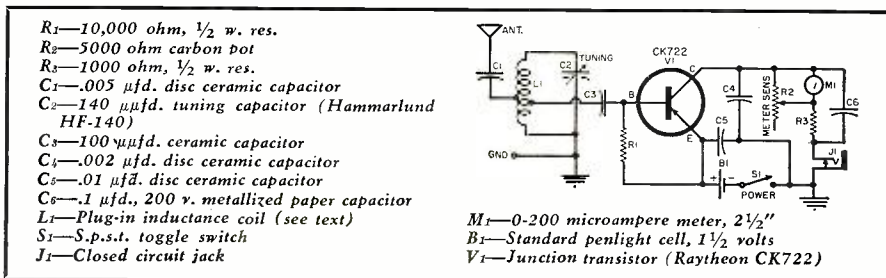



# Certified RECORD REVUE

By BERT WHYTE

**T**HE New York Audio Fair, that ear-splitting clambake, has come and gone and it is time once again to report on the hi-fi goodies the manufacturers have whipped up for your aural delectation.

But first, a few general observations might be in order. As with all past Fairs, this one was characterized by excessively loud demonstrations. The level in some rooms was very close to the threshold of pain, especially in certain rooms where the equipment was hardly of the calibre necessary to support the level with low distortion. As I admitted last year, a part of these stentorian levels is purely self defense . . . but in many cases this passion for excessive volume levels was carried far past the point of any reason. With interest in hi-fi sound increasing at a fantastic rate, thanks to a good press, one would imagine that attendance at a show like the Audio Fair would virtually guarantee a good sound demonstration. Even the most callow novice has a right to expect that when he attends an Audio Fair he hears purportedly the ne plus ultra, the cat's whiskers, the absolute last gasp in super hi-fi sound. I am very much afraid that the quality of sound that issued from a good many exhibit rooms could have done nothing but alienate a large segment of those people who were attending their first Fair. Durned if I didn't stand in a number of rooms where the distortion and imbalance were so bad you could almost taste it.

The remarks I made some years back about the indiscriminate labeling of almost any junky phonograph as "hi-fi," bear repeating now. In all truth, and sadly so, hi-fi has become a meaningless term as applied to a piece of equipment. Now, more than ever, let the buyer beware. If there was a remnant of conscience in the advertising of a few years ago, it is most certainly gone in today's blarbs. This caution may not apply to the "hep" readers of *RADIO & TELEVISION NEWS*, but the only way I can suggest to avoid the pitfalls of hi-fi buying is to deal with a reputable dealer whose business is principally hi-fi—not with the Johnny-come-lately outfit where, if bona-fide hi-fi equipment exists at all, it is subsidiary to his washing machines and refrigerators. In that kind of establishment, when the washing machine salesman can sandwich you in between his usual customers, he becomes a self-appointed audio expert and opens up his vast fund of hi-fi knowledge to you. In this whole business of buying hi-fi, most of what you do must be decided by trust. I sincerely believe that if you take the time and trouble to find out who in your area is a dealer of good reputation, you will usually find a knowledgeable audio consultant on hand to help you. Yes, use your own ears as a guide to what kind of sound you like, but don't be an ornery cuss. Listen to what the salesman has to say most carefully and you can usually

draw some pretty accurate conclusions as to his expertness. If you like what you hear, and you are getting a good conscientious demonstration, the best thing then is to TRUST this person. His knowledge and reputation were not acquired overnight. It takes time to master audio and the very worst thing you can do is to ignore this fact. DO NOT listen to your friends, no matter how well-meaning they may seem. The bitter truth is that on acquiring some hi-fi equipment and reading a few hi-fi mags and books, your friends have become "self-appointed audio experts" and paying them heed most usually results in all sorts of agonizing indecision on your part. Above all else, DON'T bring your "expert" to the store where in his noble desire to "protect" you, he can only succeed in lousing up the whole deal and in rousing the ire of the salesman. The ultimate loser is you—you'll be up in the air, more confused than ever—and most important of all, you still won't be enjoying the fruits of hi-fi in your home. I have digressed slightly, but with the growth of hi-fi the "expert" problem becomes ever greater and I thought you might like to have my views on the matter.

To return to the show—in addition to less than satisfactory sound from a technical viewpoint, one of the things I found particularly distressing was the musical aspect. If in former years the show was noisy, at least the material being demonstrated was half-way towards being decent music. This show was notable for the addiction of most of the exhibitors for certain "gimmick" records. Now, Gadirey, I'm not a hide-bound music snob—I can get as big a charge out of a well recorded gimmick as anyone—but once is about enough. In a day when there are fabulously good recordings of practically any kind of repertoire, the affront to good taste at the Fair was astounding. Over and over, the ear was subjected to the same thing. These "gimmick" records are all phonied-up with equalization to emphasize certain frequencies and any relation of these records to normal musical balance is strictly accidental. In all fairness, I must point out that most of the manufacturers of the better quality equipment used these records with discretion and, in a number of cases, not at all. It is the very nature of these "gimmick" records that they found their principal champions among the manufacturers whose products are deficient in the frequencies which are abnormally emphasized on the record. The discerning people who attended the show know what I mean, and I'll say no more. Surely, in our quest for audio perfection, we must not lose sight of the ultimate goal of all hi-fi—the better reproduction of the *music*

The opinions expressed in this column are those of the reviewer and do not necessarily reflect the views or opinions of the editors or the publishers of this magazine.

that people enjoy. It is to be hoped that the next Fair will see the "gimmick" record give way to more substantial musical fare.

From an equipment standpoint, the Fair was both disappointing and interesting. Disappointing in that a number of significant new developments did not make their promised appearance, and interesting in some unexpected equipment from unexpected sources. No product exhibited was so new and world-shaking that it dominated the Fair. Rather, it was the fruition of several products previously in the experimental stage and the refining of existing products which found major interest with the serious audiophile. For years now, binaural or stereophonic sound has been the room-filling attractions at the Fair, but for the most part people could only "ooh and ah" at the magnificent sound. The prohibitively high price of the necessary equipment, plus the dearth of pre-recorded material, deterred all but the brave and the wealthy. Last year, the situation was more or less the same and the discerning observer could see that binaural was assuming somewhat of an Olympian and, for the most part, an unobtainable ideal. Because of this, there was the beginning of a decline in interest and had the situation continued to this year, binaural sound would have been in sad shape indeed.

Happily, *Ampex* has come to the rescue with its Model 612 tape playback unit, on which I reported to you a few months ago. At \$379.00, this unit will furnish the greatest impetus to those people who have longed for a reasonably priced stereo unit. Sure, as I said before, \$379 isn't exactly beer money, but it does bring stereophonic sound within the reach of many. This is a fairly safe prediction after observing the reception the *Ampex* demonstration was given at the Fair. People flocked to the room and the demonstration was very well done, with a minimum of gimmickry and a maximum of thrilling music. The knowledge of this comparatively inexpensive stereo machine, coupled with the release of *RCA Victor* pre-recorded stereo tapes and the announced release of other material by *Westminster*, *Haydn Society*, *Urania* and others, has changed the buying viewpoint of quite a number of people I spoke to. Some went so far as to say they would not now purchase any disc playback equipment; others figured in the tape as a purchase to be made earlier than anticipated. A word of caution to those who would delete discs from their plans—the time is not yet. It will be a long time before there are sufficient tapes available to make even a sizable dent in the various repertoire. Use tape as an adjunct, yes, but don't deprive yourself of the vast musical treasury that has been built up in the LP records. I think all of you who are long time readers of this column know that I am one of the most ardent of tape enthusiasts, so when I caution about the tapes, it isn't sour grapes.

Electrostatic speakers are something else which has been kicking around the show for the past few years. The reception afforded them has been, up to now, lukewarm. The principal reason for this is that the units available have been tiny tweeters, no bigger generally than 4 inches, which crossed over at the high point of 5000 cycles. Their efficiency was very low, a characteristic of most electrostatic speakers, and no balance controls were provided, so that to the average person the addition of one of these units seemed to make very little difference. What was needed was a unit with a crossover point at least as low as a thousand cycles, and preferably even lower, so that the all-important mid-range . . . the so-called "presence" frequencies, could be produced electrostatically.

(Continued on page 132)

RADIO & TELEVISION NEWS



## Ham Special! Famous BC-645 XMITTER-RECEIVER



With DIAGRAM for Easy Conversion to CITIZENS' BAND! Makes wonderful mobile rig for 420-500 Mc. Easy to convert for phone or CW 2-way communication. CONVERSION DIAGRAM INCLUDED. This swell rig originally cost over \$1000—yours for practically a song! You get it all, in original factory carton, BRAND NEW, complete with 17 tubes, less power supply. Conversion Instructions Included. **\$29.50** Shpg. wt. 25 lbs.

**PE-101C DYNAMOTOR** for BC-645, has 12-24V input (easy to convert for 6V Battery operation) ..... only **\$7.95**  
**UHF ANTENNA ASSEMBLY**, for BC-645 ..... **\$2.45**  
**Complete set of 10 Plugs** for BC-645 ..... **\$5.50**  
**CONTROL BOX** for above ..... **\$2.25**  
**SHOCK MOUNT** for above ..... **1.25**

### HEADPHONES

Model	Description	Excellent Used	BRAND NEW
HS-23	High Impedance	\$2.25	\$4.35
HS-33	Low Impedance	1.79	4.65
HS-30	Low Imp. (featherwt.)	1.49	1.85
H-16/U	High Imp. (2 units)	2.75	7.95
CD-307A	Cords, with PL55 plug and JK26 Jack.		.88

### MICROPHONES

Model	Description	Excellent Used	BRAND NEW
T-17	Carbon Hand Mike	\$5.45	\$7.95
T-30	Carbon Throat Mike	.33	.69
T-45	Navy Lip Mike		.99
RS-39	Navy Type	2.25	4.95
T-24	Carbon Mike		3.95

## FAMOUS B-29 BOMB SIGHT

ASSEMBLED BY SPERRY GYROSCOPE CO.

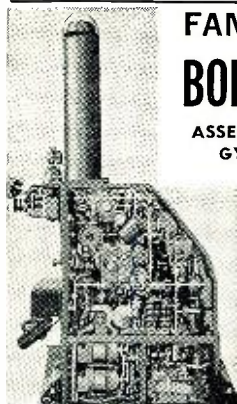

- Experimenters
- Physicists
- Schools
- Research Men
- Mechanics
- Opticians
- Laboratories
- Tech Institutes
- Engineers
- Repairmen
- Manufacturers
- Electricians

Comes in three units—the main body and two attachable periscopes, 22 and 68 inches high, alternate parts of an intricate optical system made by Eastman-Kodak Co. Main body is 35x25x14 inches. Contains at least 8 27 VDC motors, electric heater and temp. control, precision sextant, dozens of switches and controls, hundreds of fine gears and driving rods all types. Shipping wt. 250 lbs. **Cost to U. S. Govt. \$21,000. \$159.50** Your Cost BRAND NEW

### NAVY BM-2 TRANSCIEVER

**TERRIFIC BUY** for Hams, experimenters! Comprises CKP-46ADN Radio Receiver; CKP-50AEH Modulation Monitor; and CKP-35ABF Power Oscillator. Has more than 40 tubes! Complete with calibration charts, in metal cabinet 30" high, 20" wide, 20" deep. BRAND NEW, export packed, including tubes, all yours for only **\$89.50**

### BENDIX DIRECTION FINDER

MN-26-C, 12-tube remote control Navigation Direction Finder and communications receiver. 150 to 1500 Kc in 3 bands. 28 V; DC Input. Ideal for commercial navigation on boats and planes. Complete installation comprises:  
 MN-26-C Receiver complete with 12 tubes... **\$16.50**  
 MN-26-E Rotatable Loop ..... \$4.25  
 MN-22 Azimuth Control Box ..... 2.95

### MN26J DIRECTION FINDER

150 to 7 Mc. Complete with tubes, motor; original manuals. **BRAND NEW** ... **\$21.95**



### AGFA ANSCO BUBBLE SEXTANT

Made for U. S. Armed Forces. Actually worth \$150 or more! Has illuminated averaging disc for nighttime use. Complete with carrying case, recording discs, flashlight with rheostat for using sextant at night. 2X telescope for faint stars, and Allen wrench. Only **\$9.95** Complete

### BC1206-C BEACON RECEIVER

195 to 420 Kc. made by Setchel-Carlson. Works on 24-28 volts DC. 135 Kc IF. Complete with 5 tubes. Size 4" x 4" x 6". Wt. 4 lbs. **BRAND NEW** ..... **\$8.88** Used, with tubes ..... \$5.95



## TS-100/AP OSCILLOSCOPE BRAND NEW (worth \$750)

OUR LOW PRICE **\$34.50**

Can be used with linear sweep or general purpose test scope. Cables included. Also used with circular sweep as precision range calibrator. PRF rate 300-1500 per sec. Trigger input 15V @ 100V per microsec. rise. Trigger output 120V (+20V). Can be used to detect "jitter" in trigger divider circuits and modulator trigger pulse, also determining and adjusting division rate. Self-contained in metal case 8" x 12 1/2" x 16" deep. For 110V 50 to 1200 cycles AC. Demilitarized, NEW, with all tubes including crystals and C, R, Tube.

**TS-126/AP RANGE CALIBRATOR** complete with 10 tubes, **BRAND NEW**, includes scope, test leads demilitarized **\$15.45**

**TS-10A/APN & TS-10B/APN RANGE CALIBRATOR**, and measure of sensitivity of radio sets. Brand New. Complete, packed in original carrying cases. Actual value \$350. **\$19.95**

**VERY SPECIAL** ..... **\$11.95**

**BC-1151-B INDICATOR** complete with all tubes, NEW, demilitarized. **\$11.95**  
**ID-60/APA-10 SIGNAL INDICATOR**, for 115 V AC, complete with all tubes including scope tube—NEW, demilitarized. **\$16.95**  
**BC-929 INDICATOR** With tubes, excellent. **\$14.75**

### BRAND NEW 6-METER TRANSMITTER 50 WATTS

53.3 to 95 Mc. OUR PRICE **\$12.95**



A Real Hot Buy for HAMS! This complete RF Amplifier section can be easily converted for 2, 10, 15 meter, or used as exciter for higher power RF Amplifier. 3 type 815 tubes included: Xtal Oscillator and Buffer; Tripler; Final. Tubes alone worth more than our low price for entire unit! BRAND NEW, in original sealed carton. Shpg. wt. 10 lbs.

### AIRCRAFT SIGNAL TRANSMITTER-RECEIVER RADIO SET SCR-AR-283

Consists of: RECEIVER, 20 to 398 Kc and 2500 to 7850 Kc. TRANSMITTER, 2500 to 7700 Kc, for unmodulated, tone-modulated, or voice. Here's what you get, at this fantastically low price: Receiver complete with 6 tubes; transmitter complete with 4 tubes, Dyna-motor for 24 V DC operation, 5 coil sets, 2 control boxes, antenna switching relay, operating manual. ALL BRAND NEW—and All Yours, for only **\$15.95** Hurry—Limited Quantity!



## DYNAMOTORS

Type	Input	Output	Excellent Used	BRAND NEW
DM-64A	12V 5.1A	275V .150A		\$7.95
DM-40	14V 3.4A	172V .138A	1.95	3.95
DM-42A	14V 46A	515/1030/2/8 MA 215/260	8.95	12.95

DM-43A ... 28V 23A ..... 515/1030/2/8 22.50 ..... MA 215/260

DM-32A ... 28V 1.1A ..... 250V .05A ..... 2.95 5.95

DM-34D ... 12V 2.8A ..... 220V .080A ..... 4.25 5.50

DM-35D ... 12.5V 18.7A ..... 625V .225A ..... 8.95 10.95

DM-37 ..... 25.5V 9.2A ..... 625V .225A ..... 6.95 9.95

DM-28 ..... 28V ..... 224V .07A ..... 1.95 4.95

DM-53A ... 28V 1.4A ..... 220V .080A ..... 2.95 5.95

DM-33A ... 28V 5A ..... 575V .16A 28V 7A ..... 540V .25A ..... 1.95 3.95

PE-101C ... 13V 12.5A ..... 400V .135A 26V 6.3A ..... 9VAC 1.12A ..... 7.95

PE-103 ..... 6V ..... 500V .160A 12V ..... 500V .160A ..... 19.50 34.50

PE-86 ..... 28V 1.25A ..... 250V .060A ..... 2.95 5.24

### 2-VOLT "PACKAGE"

1-2V, 20 Amp. Hr. Willard Storage Battery ..... \$1.95  
 1-2V, 7 prong Synchronous Plug-in Vibrator ..... 1.45  
 1-Quart Bottle Electrolyte (for 2 cells) ..... 1.45  
**ALL BRAND NEW! Combination Price. ... \$3.99**  
**Willard 6-Volt Midget Storage Battery** 3 Amp. Hour. **BRAND NEW**. 3 5/8" x 1-13/16" x 2 3/8". Uses Standard Electrolyte. .... Only **\$1.85**  
 Please include 25¢ deposit with order—Balance C.O.D. **MINIMUM ORDER \$3.00**. All Shipments F.O.B. Our Warehouse N.Y.C.



## BC-946-B BROADCAST RECEIVER

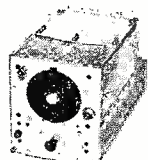

520 to 1500 Kc broadcast band. 6 tubes: 3-12SK7, 12SR7, 12A6, 12KS. For dynamotor operation. Easily converted to 110 volt or 32 volt use. Two IF stages, 3-gang tuning cond. In sealed carton, with all tubes. **BRAND NEW** ..... **\$19.95**

### SCR-274 COMMAND EQUIPMENT

All Complete With Tubes	Description	Used	Excellent Used	BRAND NEW
BC-453	Receiver 190-550 Kc	\$9.95	\$11.95	\$14.95
BC-454	Receiver 3-6 Mc	7.19	8.29	11.95
BD-455	Receiver 6-9 Mc	5.25	7.95	9.95
BC-457	Modulator 1-2.3 Mc	2.24	2.75	4.24
BC-458	Transmitter 1-2.3 Mc	7.95	11.95	12.95
BC-458	Transmitter 5.3-7 Mc	5.95	7.95	8.95
BC-459	Transmitter 7-9.1 Mc	7.95	8.95	11.95
BC-450	3-Receiver Control Box		1.49	1.95
BC-451	Transmitter Control Box		1.25	1.49
BC-696	Transmitter 3-4 Mc		14.75	19.50

### ARC-5 MARINE RECEIVER-TRANSMITTER

Navy Type Comm. Receiver 1.5 to 3 Mc BRAND NEW with 6 tubes. .... \$16.95  
 Navy Type Comm. Transmitter 2.1-3 Mc BRAND NEW with 4 tubes and Xtal. .... \$12.45



### LORAN APN-4

FINE QUALITY NAVIGATIONAL EQUIPMENT

Determine exact geographic position of your boat or plane! Complete, BRAND NEW installation consists of: ID-6B/APN-4 Indicator; R-9B/APN-4 Receiver; PE-206 Inverter; Set of Plugs; Visor for Indicator; Operation manual; Brand New, Export packed. **COMPLETE**. **\$129.50**

### R-65/APN-9 LORAN Receiver-Indicator

Furnishes position data at greater distances from transmitting stations than is possible by any other methods. Accurate to within 1% of distance from ground transmitters. Operates entirely by radio. Complete in one case. BRAND NEW export packed. **\$295.00**

### ARC-5/R-28 RECEIVER

2 Meter superhet, 100 to 156 Mc in 4 xtal channels. Louvred alum, cabinet 7 3/4 x 4 7/8 x 14". Complete with 10 tubes and 4 xtals. Excel. Cond. .... **\$14.95**

### ARC-5/T-23 TRANSMITTER

Companion for above, incl. 2-832A, 2-1625 tubes and 4 xtals. .... **\$22.50**

### BC-221 FREQ. METER CASE

Aluminum case for BC-221 or TS-164 Freq. Meters. With volt. reg. supply using VR105. 2 ballast tubes, relay, cable, etc. Inside front: 9 3/4 x 7 1/2 x 7 3/4". Inside rear: 2" deep. Shock-mounted. BRAND NEW, (Add 50c for packing) **\$3.45**

Original Crystal for BC-221, NEW. .... \$8.45

### NEW COMPLETE I.F.F.

**Equipment RC-188-A**  
 Originally cost about \$20,000 now buy it for a tiny fraction of cost! Easily converted for Television. Complete assembly consists of Control unit with 6 C.R. Tube, transmitter and receiver assembly (157 to 185 Mc), Indicator unit, and Power Supply (450 watts), operating on 110 volts, 60 cycles AC. All assembled, ready to operate. 62 Tubes included: 8-6V6GT, 9-6SL7GT, 14-6SN7GT, 1-5CP1, 2-9006, 1-6Y6G, 2-6E5, 1-100TH, 2-6J5, 2-2C26, 1-3E29, 1-6H6, 7-6AG5, 3-6AK5, 1-6C4, 3-2X2, 1-6X5GT, 35U4GT. Overall size 55" high, 28" wide, 20 1/2" deep. Shpg. weight 855 lbs. Your cost, complete, BRAND NEW, in original packing **\$169.50**



### SCR-522 FINEST 2-METER RIG!

Terrific buy! VHF Transmitter-Receiver, complete with all components. 100-156 Mc. 4 channels. Xtal-controlled, Amplitude modulated voice. They're going fast! Excellent condition. **SCR-522 Transmitter-Receiver**, complete with all 18 tubes. **\$39.50**  
**COMBINATION** ..... Special **\$21.25**  
 Receiver only, with all tubes ..... **\$24.50**  
 Transmitter only, with all tubes ..... **\$24.50**



# Pilot

brings to  
**HIGH  
FIDELITY**  
the  
**'All-On-One'**

## HF-56

**FM-AM TUNER  
PHONO PREAMP  
TONE CONTROLS  
35-WATT AMPLIFIER**

**All components on  
One chassis  
for easy  
Hi-Fi Installation**

**HF-56 \$20950**

**CABINET OPTIONAL**

Mahogany ..... \$18.95  
Blond ..... 19.95  
prices slightly higher west of Rockies

At PILOT dealers, or send for complete details:

**PILOT RADIO CORP.** Dept. LA-4  
37-06 36th St., L. I. C. 1, New York

Please send complete description of the new HF-56. I am also interested in the following literature.

- Pilot AM-FM Tuners
- Pilot Amplifiers
- Pilot Component-Console Systems

Name.....

Address.....

City.....Zone.....State.....

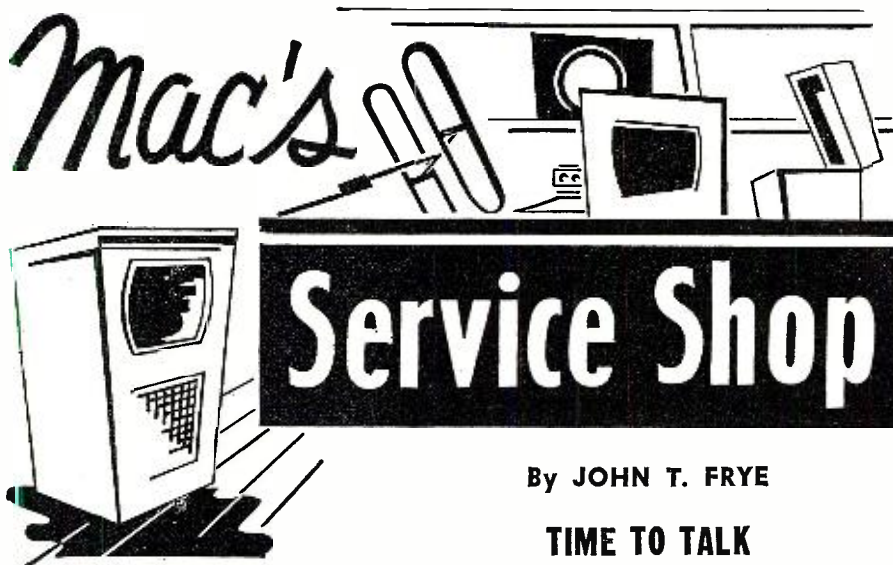

By JOHN T. FRYE

### TIME TO TALK

**B**USINESS was a little slow in Mac's Service Shop. People were still recovering from their Christmas spending, and it would take a payday or so to make them "well" again.

Barney was working away on a portable set, while Mac, his employer, was busy at the other end of the bench doing some testing with the oscilloscope purchased a couple of months back. A probe connected to the horizontal input terminals of the scope went to the output terminals of the square-wave generator. Mac carefully studied a book spread out in front of him on the bench and then inserted an insulated screwdriver into the rear one of two small holes in the probe body and turned the screw inside first one way and then the other. As he did so, the square wave displayed on the face of the tube grew taller and shorter and the top portion tilted first one way and then the other. When he was satisfied with this adjustment, Mac shifted his screwdriver to the other opening and started turning the screw inside. This time the leading corner of the square wave rounded off or developed a sharp spike in accordance with the setting of the adjustment.

"Hey!" Barney exclaimed, "what are you doing reading a book? I thought you knew all the answers. What are you trying to do, anyway?"

"You never heard me claim I knew all the answers," Mac said emphatically as his face wrinkled in a tolerant grin. "That's about the last thing I should be likely to say as long as I'm working in this ego-humbling racket. This book is called simply 'Probes,' and it is written by Bruno Zucconi and Martin Clifford. It contains about all there is to say on probes that are used with v.t.v.m.'s, oscilloscopes, or other instruments to increase their range and usefulness. Every kind of probe from the simple direct type to the chromatic probe used in color TV work is discussed. The circuits of various probes, how they are constructed, how and where each is used, how they are adjusted, the limitations of each type, how you can make your own—

these are some of the subjects covered. While many of these subjects have been written up over the years in various magazine articles, it is mighty handy to have everything you are likely to want to know about probes all in one book so you can refer to it as the need arises—as I have just been doing."

"What were you doing?"

"This new scope has a much lower input capacity and higher impedance than did our old job for which the 10-to-1 low-capacity probe and the 100-to-1 high-voltage probe were adjusted. It was necessary to adjust both probes so that their voltage-dividing function would be accurately matched to the impedance of the new scope and provide the proper specified attenuation. In addition, the low-capacity probe had to have its frequency-compensating adjustment matched to the new horizontal input impedance so that it would pass all frequencies without discrimination."

"Well, while you have been playing around with that interesting but non-productive stuff, I've been paying the rent," Barney announced importantly. "The last set in the shop is now ready to go."

"What was wrong with it?" Mac asked casually.

"Strictly routine," Barney said with a yawn. "It was a three-way portable in which the oscillator cut out when the line voltage fell below 110 volts. I put in a new 1R5, and now the oscillator holds in right down to 100 volts. And oh yes, just as I was tagging it with the bill, I noticed the dial lamp was out and I replaced it. It's very unusual to find a dial lamp on these jobs; so that's why I didn't spot it before. The lamp is one of those 50 ma. jobs, a #49 if I recall correctly."

"It seemed to me the set played a lot louder after you put in that lamp," Mac observed, still with great casualness.

"Yeah," Barney admitted, "how about that? That's the first time I ever remember that a new pilot lamp helped the volume."

"Just for kicks, suppose you put the

**RADIO & TELEVISION NEWS**



old 1R5 back in and use the isolation transformer to run the line voltage down again until the oscillator cuts out," Mac suggested as he went over to the steel cabinets holding the service data.

"Well, all right, if you say so; but I don't see the sense of it," Barney grumbled. "I told you I did that the very first thing."

With the old 1R5 in the socket, the line voltage had to be dropped below 90 volts before the oscillator quit.

"Well, how do you like that!" Barney marvelled. "Now the old tube works at a lower voltage than the new one did. What's going on here?"

Mac heaved a great sigh of sorely tried patience before he answered.

"If I have told you once, I've told you two dozen times: whenever you notice any deviation at all from normal operation, find out *why* this strange behavior is going on. When you noticed that the new pilot lamp increased the volume, you should have headed for those data file cabinets at once to study the diagram of the set and see if you could find a reason for this phenomenon. Now take a look at the diagram: the dial lamp is shunted across a 270-ohm resistor that is right in the high-voltage lead coming out of the selenium rectifier. Both the 'B-plus' current and the filament current for the tubes must flow through the pilot lamp and the resistor in parallel. When the pilot lamp is burned out, the resistor must carry the whole load; and the voltage drop across this portion of the circuit increases while the current passed through it decreases. The voltage drop, as far as the plate voltage on the tubes is concerned is of little consequence; but the decrease in the current that flows through the series filament string is sufficient to drop those filaments below their proper temperature, even at 117 line volts. When the line voltage drops a little, there is not enough emission from the 1R5 filament to keep it oscillating."

"How come a new 1R5 worked down to 100 volts?"

"A new tube always has a little 'extra' emission that soon disappears. If you had let this set go out, it would have been back in a few days with the same complaint as the initial surplus emission of the new 1R5 disappeared."

"When I replaced the pilot lamp, I brought the current of the whole filament string back to normal, and that accounted for the increase in volume; right?"

"Right. Low emission produces more spectacular results in an oscillator tube than it does in an amplifying tube; but all the tubes in the string were running with below-normal current through their filaments when the pilot lamp was out."

Barney tore up the bill on the set and started to make out a new one.

"Write out a little note to the effect that it is highly important to replace the pilot lamp in this receiver as soon as it burns out and pin that to the

(Continued on page 90)

... another  
**MALLORY**  
service-engineered  
product

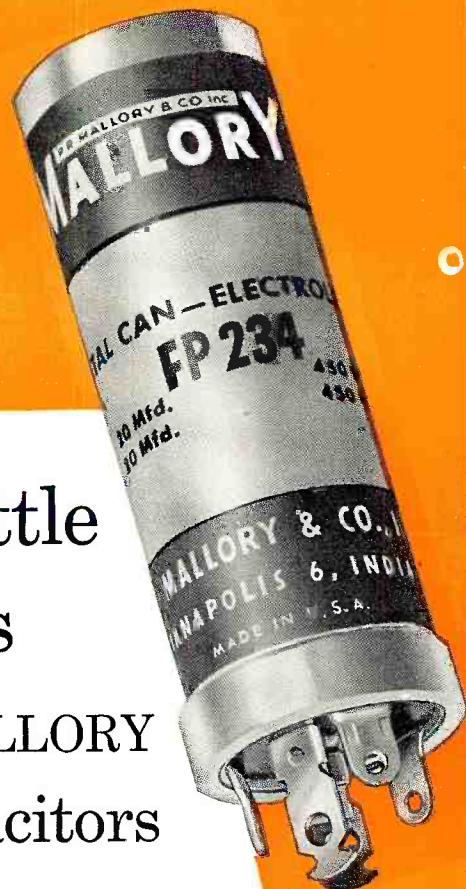

## Don't Settle For Less than MALLORY FP Capacitors

Only Mallory makes genuine FP Electrolytic Capacitors. Don't accept substitutes or imitations—for only FP Capacitors give you *all* these exclusive features, pioneered by Mallory and available without premium cost:

- Designed for 85° C—no de-rating
- Genuine fabricated plate anode
- High ripple current rating
- Unequalled shelf and service life
- Fast, easy twist-prong mounting

Always ask for Mallory FP's *by name*—and you'll be sure of getting the best replacement capacitors on the market.

P. R. MALLORY & CO. Inc.  
**MALLORY**

P. R. MALLORY & CO. Inc., INDIANAPOLIS 6, INDIANA

- Capacitors
- Vibrators
- Resistors
- Power Supplies
- Controls
- Switches
- Rectifiers
- Filters
- Mercury Batteries



**JACKSON  
INSTRUMENTS**

make more  
\$ profits \$

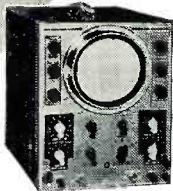

**Model CRO-2  
Wide Band  
Oscilloscope**  
\$22500 Dealer  
Net.

Flat within 1 db, 20 cycles thru 4.5 mc.\* Maximum deflection sensitivity .018 r.m.s. volt-per-inch. Incorporates Horizontal Sweep Expansion, Sweep Polarity Reversal, big 5-inch CR tube, Linear Sweep Oscillator 20 cycles thru 50 kc.

\*NOTE: Scopes down 3 db at 4.5 mc. are actually down 30%!

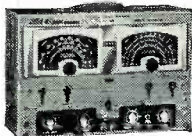

**Model TVG-2  
Television  
Generator**  
\$25995 Dealer  
Net.

Complete television Signal Generator for VHF, IF, color. Sweep Oscillator 20 kc. thru 216 mc. all on fundamentals. Sweep width 0 thru 18 mc. Marker Oscillator 4 mc. thru 216 mc. all on fundamentals. Separate Crystal Oscillator.

**NEW!** Model 49  
Tube Tester

with Plug-In Accessories

\$4995

Dealer  
Net.



Accessory Testers  
as low as \$6.95.

Brand new, fully flexible tube tester with plug-in accessories for making other tests. Lever action and big 4½" meter, plus speed chart for rapid testing. Accessories for measuring Heater Current, High Resistance Shorts to 2 megohms, and checking selenium rectifiers now available, others soon.

Available from Leading Distributors

**JACKSON**

"Service Engineered" Test Equipment

16-18 S. Patterson Boulevard Dayton 2, Ohio  
In Canada: The Canadian Marconi Co.

# BETTER RECORDS — A RESULT OF BETTER PROCESS

*A rather simple method—yet it will produce  
better records at less cost to the consumer.*

**A** NEW process for commercial production of high quality phonograph records was recently announced by Custom Records, Inc., 41 E. 42nd St., New York 17, N. Y. The equipment required in this new process is rather simple, consisting of two machines; a processing machine weighing less than 80 lbs. used for both heating and cooling cycles, and a very simple edge trimmer. Pressure required is approximately 500 lbs. per square inch (it may even go as low as 165 psi) as compared to 2000 psi in present day processes.

The actual operation takes about 10 to 15 seconds for heating at a temperature of 300 degrees F. and a similar period of time for cooling. Up to four records can be produced per minute.

The key to this new technique is in the use of Vinylite in its earliest stage of processing. The raw material is in near powdered form—just heated to the point of cohering. In this state it is more malleable and therefore requires less effort on the part of the machine to process.

This is considerably different than present techniques. The process prac-

ticed today uses the same Vinylite, but after it has been formed into a homogeneous mass. This makes of it a relatively hard substance requiring high pressures and heat for pressing the record. During the pressing process, there is considerable pressure from the center of the disc toward its outer diameter. This results in a granular "flow" of the Vinylite from the center towards the outer area. The results are eventual wear and tear on the record master and all in all a poorer quality reproduction. Since the new method uses Vinylite in a powdery form, these pitfalls are not confronted.

The advantages of this new system are of considerable interest to all individuals who enjoy better quality reproductions. As pointed out by R. I. Mendels, newly-elected president of the company, the advantages are a recording that is superior to any produced today—has less background noise and better high-frequency response. In addition, the cost of processing is considerably lower which eventually will be passed along to the consumer. —50—

K. R. Smith (left) and James A. Miller, who developed the new process, demonstrate the recording process. Shown at the right is the small, compact electrically heated hydraulic press. After automatic heating and cooling in the press, the record is punched and trimmed in a separate operation.





# Heathkits

FOR THE ENTIRE ELECTRONICS INDUSTRY

more than 65 top-quality models to choose from, including such outstanding kit designs as . . .

THE  
WORLD'S LEADING  
MANUFACTURER  
OF ELECTRONIC  
KITS . . .

AMATEUR  
RADIO



RADIO & TV  
SERVICEMEN



INDUSTRIAL  
LABORATORIES



TRAINING  
SCHOOLS

HI-FI  
ENTHUSIASTS



**V-7A VACUUM TUBE VOLTMETER:** Easily the world's largest selling VTVM. Features peak-to-peak scales—etched metal circuit board—1% precision resistors—full wave rectifier and AC input circuit—reads rms and peak-to-peak AC, DC, and ohms.

**O-10 LABORATORY TYPE OSCILLOSCOPE:** The world's largest selling oscilloscope kit, and the most successful oscilloscope in history. Designed especially for color and black-and-white TV service work. Its 5 megacycle bandwidth and new 500 Kc sweep generator readily qualify it for laboratory applications. Features easy-to-assemble etched metal circuit board construction.

**WA-P2 HIGH FIDELITY PREAMPLIFIER:** This is the world's largest selling hi fi preamplifier kit. Features complete equalization, 5 separate switch-selected inputs with individual pre-set level controls, beautiful modern appearance, high-quality components.

**HIGH FIDELITY AMPLIFIERS:** Five Heathkit Models to choose from at prices ranging from \$16.95 to \$59.75. Power output range from 7 to 25 watts.

**DX-100 TRANSMITTER:** A 100 watt phone and CW ham transmitter, offering the greatest dollar value available in the ham radio field today.

*Greatest Dollar Value Through Factory-To-You Selling!*

**ONLY** Heathkits **CAN GIVE YOU ALL**  
**OF THESE DISTINCTIVE ADVANTAGES!**

- *The Most Complete Construction Manuals for Easy Assembly.*
- *Originality of Design—Developed Through Pioneering in the Kit Instrument Field.*
- *Greatest Dollar Value—Finest Quality with Real Economy.*
- *Direct Contact with Manufacturer—Lower Price, Guaranteed Performance.*
- *Etched Metal, Prewired Circuit Boards—Save Construction Time, Improve Performance.*
- *High Quality Standard Components for Long-Life Service.*

**HEATH COMPANY**

*A Subsidiary  
of Daystrom, Inc.*

**BENTON HARBOR 15, MICHIGAN**



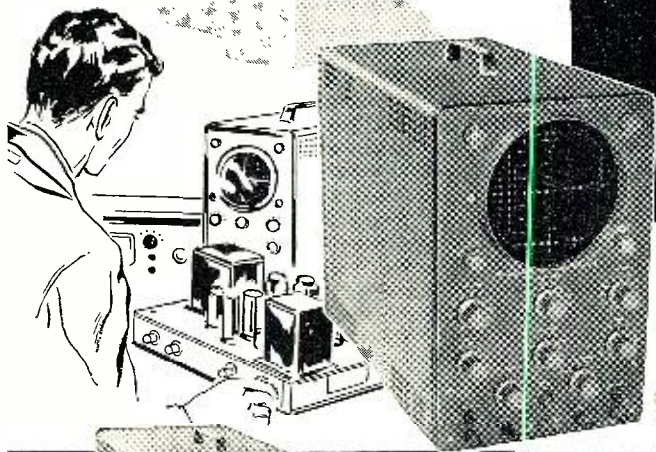

there is no substitute for  
**HEATHKIT QUALITY**

YOU GET MORE: All first-run, top quality parts—the latest in electronic design—complete and comprehensive step-by-step assembly instructions with large pictorial diagrams and assembly drawings. Proven performance through the production of thousands of kits.

MODEL O-10

1

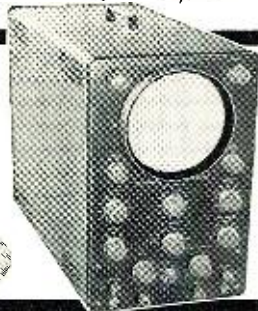

2

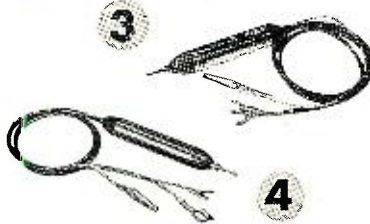

3

4

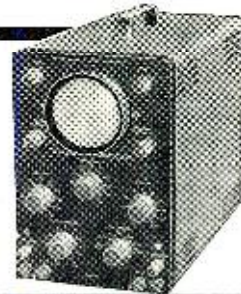

5

**1** Heathkit ETCHED CIRCUIT  
COLOR-TV  
**5" OSCILLOSCOPE KIT**

This deluxe quality oscilloscope has proven itself through thousands of operating hours in service shops and laboratories. Features the best in components—and the best in circuit design.

Features amplifier response to 5 Mc for color TV work, and employs the radically new sweep circuit to provide stable operation up to 500,000 cps. In addition, etched metal, pre-wired circuit boards cut assembly time almost in half, and permit a level of circuit stability never before achieved in an oscilloscope of this type.

Vertical amplifiers flat within +2 db -5 db from 2 cps to 5 Mc, down only 1½ db at 3.58 Mc. Vertical sensitivity is 0.025 volts, (rms) per inch at 1 Kc. 11 tube circuit employs a 5UP1 CRT.

Plastic molded capacitors used for coupling and bypass—preformed and cabled wiring harness provided.

Features built-in peak-to-peak calibrating source—retrace blanking amplifier—push-pull amplifiers and step-attenuated input.

MODEL O-10

**\$6950**

Shpg. Wt. 21 Lbs.

**3** Heathkit LOW CAPACITY  
**PROBE KIT**

Scope investigation of circuits encountered in TV requires the use of special low capacity probe to prevent loss of gain, circuit loading, or distortion. This probe features a variable capacitor to provide correct instrument impedance matching. Also the ratio of attenuation can be controlled.

NO. 342

**\$350**

Shpg. Wt. 1 Lb.

**4** Heathkit ETCHED CIRCUIT  
**SCOPE DEMODULATOR PROBE KIT**

Extend the usefulness of your Oscilloscope by observing modulation envelope of R.F. or I.F. carriers found in TV and radio receivers. Functions like AM detector to pass only modulation of signal and not signal itself. Applied voltage limits are 30 V. RMS and 500 V. DC.

NO. 337-C

**\$350**

Shpg. Wt. 1 Lb.

**2** Heathkit ETCHED CIRCUIT  
**5" OSCILLOSCOPE KIT**

This is a general purpose oscilloscope for the more usual applications in the service shop or lab, yet is comparable to scopes costing many dollars more.

Features full size 5" CRT (5BP1), built-in peak-to-peak voltage calibration—3 step input attenuator—phasing control—push-pull deflection amplifiers—and etched metal pre-wired circuit boards.

Vertical channel flat within ±3 db from 2 cps to 200 Kc, with 0.09 V. rms/inch, peak-to-peak sensitivity at 1 Kc. Sweep circuit from 20 cps to 100,000 cps. A scope you will be proud to own and use.

MODEL OM-1

**\$4950**

Shpg. Wt. 21 Lbs.

**5** Heathkit ETCHED CIRCUIT  
**3" OSCILLOSCOPE KIT**

This compact little oscilloscope measures only 9½" H. x 6½" W. x 11¼" D., and weighs only 11 lbs! Easily employed for home service calls, for work in the field or is just the ticket for use in the ham shack or home workshop. Incorporates many of the features of the Model OM-1, but yet is smaller in physical size for portability.

Employing etched circuit boards, the Model OL-1 features vertical response within ±3 db from 2 cps to 200 Kc. Vertical sensitivity is 0.25 V. RMS/inch peak-to-peak, and sweep generator operates from 20.cps to 100,000 cps. Provision for r.f. connection to deflection plates for modulation monitoring, and incorporates many features not expected at this price level. 8-tube circuit features a type 3GP1 Cathode Ray Tube.

MODEL OL-1

**\$2950**

Shpg. Wt. 14 Lbs.

**HEATH COMPANY**

A Subsidiary  
of Daystrom, Inc.

**BENTON HARBOR 15, MICHIGAN**



# fill your test requirements WITH HEATHKITS

DESIGNED FOR YOU: Heath Company test equipment is designed for the maximum in convenience. Besides being functional, Heathkits represent the very latest in modern physical appearance, and incorporate all the latest circuit design features for comprehensive test coverage.

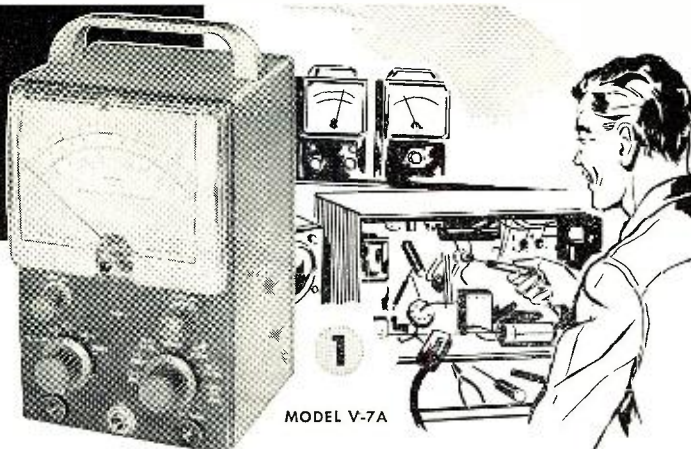

MODEL V-7A

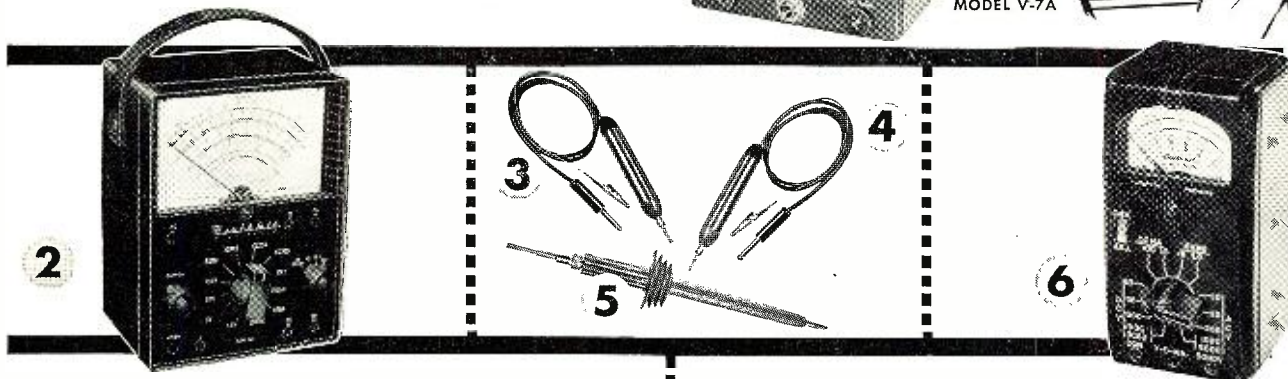

## 1 Heathkit ETCHED CIRCUIT VACUUM TUBE VOLTMETER KIT

Besides measuring AC (rms), DC and resistance, the modern-design V-7A incorporates peak-to-peak measurement for FM and television servicing.

AC (rms) and DC voltage ranges are 1.5, 5, 15, 50, 150, 500, and 1500. Peak-to-peak AC voltage ranges are 4, 14, 40, 140, 400, 1400, and 4000. Ohmmeter ranges are X1, X10, X100, X1000, X10K, X100K, and X1 megohm. Also a db scale is provided. A polarity reversing switch provided for DC measurements, and zero center operation within range of front panel controls. Employs a 200  $\mu$ a meter for indication. Input impedance is 11 megohms.

Etched metal, pre-wired circuit board for fast, easy assembly and reliable operation is 50% thicker for more rugged physical construction. 1% precision resistors for utmost accuracy.

MODEL V-7A

**\$2450**

Shpg. Wt. 7 Lbs.

## 2 Heathkit 20,000 OHMS/VOLT MULTIMETER KIT

The MM-1 is a portable instrument for outside servicing, for field testing, or for quick portability in the service shop. Combines attractive physical appearance with functional design. 20,000 ohms/v. DC, and 5000 ohms/v. AC. AC and DC voltage ranges are 0-1.5, 5, 50, 150, 500, 1500 and 5000 volts. Direct current ranges are 0-150  $\mu$ a., 15 ma., 150 ma., 500 ma., and 15 amperes. Resistance ranges are X1, X100, X10,000 providing center scale readings of 15, 1500 and 150,000 ohms. DB ranges cover -10 db to +65 db.

Features a  $4\frac{1}{2}$ " 50  $\mu$ a. meter. Provides polarity reversal on DC measurements. 1% precision resistors used in multiplier circuits. Not affected by RF fields.

MODEL MM-1

**\$2950**

Shpg. Wt. 6 Lbs.

## 3 Heathkit ETCHED CIRCUIT RF PROBE KIT

The Heathkit RF Probe used in conjunction with any 11 megohm VTVM will permit RF measurements up to 250 Mc with  $\pm 10\%$  accuracy. Uses etched circuits for increased circuit stability and ease of assembly.

NO. 309-C  
**\$350**

Shpg. Wt. 1 Lb.

## 4 Heathkit ETCHED CIRCUIT PEAK-TO-PEAK PROBE KIT

Now read peak-to-peak voltages on the DC scale of any 11 megohm VTVM with this new probe, employing etched circuit for stability and low loss. Readings made directly from VTVM scales, from 5 Kc to 5 Mc. Not required for Heathkit Model V-7A VTVM.

NO. 338-C  
**\$550**

Shpg. Wt. 2 Lbs.

## 5 Heathkit 30,000 VOLT D.C. HIGH VOLTAGE PROBE KIT

For TV service work or similar application for measurement of high DC voltage. Precision multiplier resistor mounted inside plastic probe. Multiplication factor of 100 on the ranges of Heathkit 11 megohm VTVM.

NO. 336  
**\$450**

Shpg. Wt. 2 Lbs.

## 6 Heathkit HANDITESTER KIT

The Model M-1 measures AC or DC voltage at 0-10, 30, 300, 1000, and 5000 volts. Measures direct current at 0-10 ma. and 0-100 ma. Provides ohmmeter ranges of 0-3000 (30 ohm center scale) and 0-300,000 ohms (3000 ohms center scale). Features a 400  $\mu$ a. meter for sensitivity of 1000 ohms/volt. Because of its size, the M-1 is a very handy portable instrument that will fit in your coat pocket, tool box, glove compartment, or desk drawer. Makes a fine standby unit in the service shop when the main instruments are in use, or is ideal for the hobbyist or beginner. An unusual dollar value.

MODEL M-1  
**\$1450**

Shpg. Wt. 3 Lbs.

**HEATH COMPANY** A Subsidiary of Daystrom, Inc. **BENTON HARBOR 15, MICHIGAN**



# Heathkit TV ALIGNMENT GENERATOR KIT



1



2



3



4

**HEATH  
COMPANY**  
A SUBSIDIARY OF DAYSTROM INC.

The Model TS-4 features a controllable inductor for all-electronic sweep, improved oscillator and automatic gain circuitry, high RF output, center sweep operation, and improved linearity. It sets a new high standard for sweep generator operation, and is absolutely essential for the up-to-date service shop doing FM, black-and-white TV, and color TV work.

Voltage regulation and effective AGC action insure flat output over a wide frequency range. Electronic sweep insures complete absence of mechanical vibration. Sweep deviation controllable from 0 up to 40 Mc, depending upon base frequency.

Effective two-way blanking.  
Fundamental output from 3.6 Mc to 220 Mc in 4 bands. Crystal marker provides markers at 4.5 Mc and multiples thereof. Crystal included with kit. Variable marker covers from 19 Mc to 60 Mc on fundamentals, and up to 180 Mc on harmonics. Provision for external marker.



MODEL TS-4  
**\$4950**  
Shpg. Wt. 16 Lbs.

1

## Heathkit LINEARITY PATTERN GENERATOR KIT

The new-design Model LP-1 produces vertical or horizontal bar patterns, a cross-hatch pattern, or white dots on the screen of the TV set under test. No internal connections required. Special clip is attached to the TV antenna terminals. Instant selection of the pattern desired for adjustment of vertical and horizontal linearity, picture size, aspect ratio, and focus. Dot pattern presentation is a *must* for color convergence adjustments on color TV sets.

Extended operating range covers all television channels from 2 to 13. Produces 6 to 12 vertical bars or 4 to 7 horizontal bars.

MODEL LP-1  
**\$2250**  
Shpg. Wt. 7 Lbs.

2

## Heathkit LABORATORY GENERATOR KIT

The Heathkit Model LG-1 Laboratory Generator is a high-accuracy signal source for applications where metered performance is essential. It covers from 100 Kc to 30 Mc on fundamentals in 5 bands. Modulation is at 400 cycles, and modulation is variable from 0-50%. RF output from 100,000  $\mu$ v. to 1  $\mu$ v. 200  $\mu$ a. meter reads the RF output in microvolts, or percentage of modulation. Fixed step and variable output attenuation provided.

Features voltage regulation, and double copper plated shielding for stability. Provision for external modulation. Coaxial output cable (50 ohms).

MODEL LG-1  
**\$3950**  
Shpg. Wt. 16 Lbs.

3

## Heathkit CATHODE RAY TUBE CHECKER KIT

This new-design instrument holds the key to rapid and complete picture tube testing, either in the set, on the work-bench, or in the carton. Tests for shorts, leakage, and emission. Features Shadow-graph test (a spot of light on the screen) to indicate whether the tube is capable of functioning.

The Model CC-1 tests all electromagnetic deflection picture tubes normally encountered in television servicing. Supplies all operating voltages to the tube under test, and indicates the condition of the tube on a large "GOOD-BAD" scale. Features spring loaded test switches for operator protection.

The CC-1 is housed in an attractive portable case and is light in weight - ideal for outside service calls.

MODEL CC-1  
**\$2250**  
Shpg. Wt. 10 Lbs.

4

## Heathkit DIRECT READING CAPACITY METER KIT

Not only is this instrument popular in the service shop, but it has found extensive application in industrial situations. Ideal for quality control work, production line checking, or for matching pairs.

Features direct reading linear scales from 100 mmf to .1 mfd full scale. Necessary only to connect a capacitor of unknown value to the insulated binding posts, select the correct range, and read the meter. The CM-1 is not susceptible to hand capacity, and has a residual capacity of less than 1 mmf.

MODEL CM-1  
**\$2950**  
Shpg. Wt. 7 Lbs.





MODEL SG-8 \$1950  
Shpg. Wt. 8 Lbs.

This is one of the biggest signal generator bargains available today. The tried and proven Model SG-8 offers all of the outstanding features required for a basic service instrument. High quality components and outstanding performance.

The SG-8 covers 160 Kc to 110 Mc on fundamentals in 5 bands, and calibrated harmonics extend its usefulness up to 220 Mc. The output signal is modulated at 400 cps, and the RF output is in excess of 100,000 uv. Output controlled by both a continuously variable and a fixed step attenuator. Also, audio output may be obtained for amplifier testing. Don't let the

low price deceive you. This is a professional type service instrument to fulfill the signal source requirements in the service lab.

# Heathkit SIGNAL GENERATOR KIT

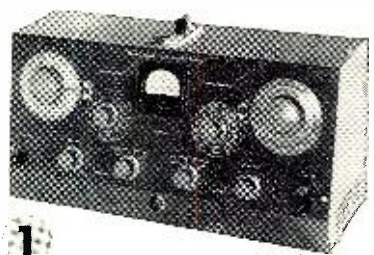

1

## 1 Heathkit . . . IMPEDANCE BRIDGE KIT

The IB-2 features built-in adjustable phase shift oscillator and amplifier, and has panel provisions for external generator. Measures resistance, capacitance, inductance, dissipation factors of condensers, and storage factor of inductance.

D, Q, and DQ functions combined in one control. 1/2% resistors and 1/2% silver-mica capacitors especially selected for this instrument. A 100-0-100 microammeter provides null indications. Two-section CRL dial provides 10 separate "units" with an accuracy of .5%. Fractions of units read on variable control.

MODEL IB-2  
\$5950  
Shpg. Wt. 12 Lbs.

## 2 Heathkit "Q" METER KIT

The Heathkit Model QM-1 will measure the Q of inductances and the RF resistance and distributed capacity of coils. Employs a 4 1/2" 50 microampere meter for direct indication. Will test at frequencies of 150 Kc to 18 Mc in 4 ranges. Measures capacity from 40 mmf to 450 mmf within ± 3 mmf. Indispensable for coil winding and determining unknown condenser values. A worthwhile addition to your laboratory at an outstandingly low price. Useful for checking wave traps, chokes, peaking coils, etc. Laboratory facilities are now available to the service shop and home lab.

MODEL QM-1  
\$4450  
Shpg. Wt. 14 Lbs.

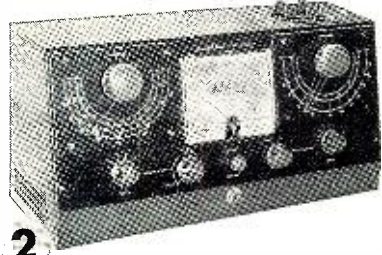

2

## 3 Heathkit 6-12 VOLT BATTERY ELIMINATOR KIT

This modern battery eliminator will supply 6 or 12 volt output for ordinary automobile radios as well as 12 volts for the new models in the latest model cars. Output voltage is variable from 0-8 volts DC, or 0-16 volts DC. Will deliver up to 15 amperes at 6 volts, or up to 7 amperes at 12 volts. Two 10,000 microfarad filter capacitors insure smooth DC output. Two panel meters monitor output voltage and current. Will double as a battery charger. Definitely required for automobile radio service work.

MODEL BE-4  
\$3150  
Shpg. Wt. 17 Lbs.

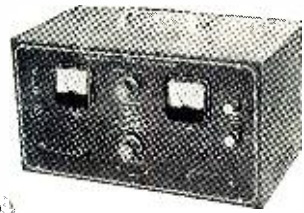

3

## 4 Heathkit DECADE RESISTANCE KIT

Twenty 1% precision resistors provide resistance from 1 to 99,999 ohms in 1 ohm steps. Indispensable around service shop laboratory, ham shack, or home workshop. Well worth the extremely low Heathkit price.

MODEL DR-1  
\$1950  
Shpg. Wt. 4 Lbs.



4

## 5 Heathkit VIBRATOR TESTER KIT

Tests vibrators for proper starting and indicates the quality of the output on a large "GOOD-BAD" scale. Checks both interrupter and self-rectifier types in 5 different sockets. Operates from any battery eliminator delivering variable voltage from 4 to 6 volts DC at 4 amps. Ideal companion to the Model BE-4.

MODEL VT-1  
\$1450  
Shpg. Wt. 6 Lbs.

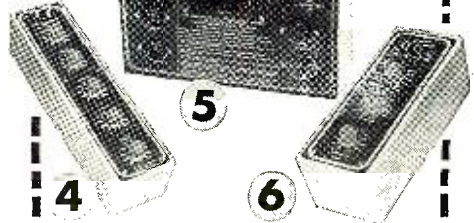

5

## 6 Heathkit DECADE CONDENSER KIT

Provides capacity values from 100 mmf to 0.111 mfd in steps of 100 mmf. ± 1% precision silver-mica condensers used. High quality ceramic switches for reduced leakage. Polished birch cabinet. Extremely valuable in all electronic activity.

MODEL DC-1  
\$1650  
Shpg. Wt. 3 Lbs.

6

# HEATH COMPANY

A SUBSIDIARY OF DAYSTROM INC.

BENTO HARBOR 15, MICHIGAN



# Heathkit TUBE CHECKER KIT

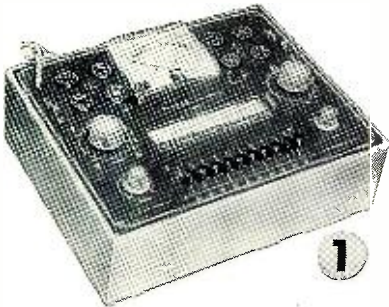

**1** The Heathkit Model TC-2 is an emission type tube tester that represents a tremendous saving over the price of a comparable unit from any other source. At only \$29.50, you can have a tube tester of your own, even if you are an experimenter, or only do part time service work. Extremely popular with radio servicemen, it uses a 4½" meter with 3-color meter face for simple "GOOD-BAD" indications that the customer can understand. Will test all tubes commonly encountered in radio and TV service work.

Ten 3-position lever switches for "open" or "short" tests on each tube element. Neon bulb indicates filament continuity or short between tube elements. Line adjust control provided. The roll chart is illuminated.

Sockets provided for 4, 5, 6, and 7-pin, octal, and loctal tubes, 7 and 9 pin miniature tubes, and the 5 pin Hytron tubes. Blank space provided for future socket addition. Tests tubes for opens, and shorts, and for quality on the basis of total emission. 14 different filament voltage values provided.

MODEL TC-2  
**\$29.50**  
Shpg. Wt. 12 Lbs.

## **2** Heathkit PORTABLE TUBE CHECKER KIT

The Model TC-2P is identical to the Model TC-2 except that it is housed in a rugged carrying case. This strikingly attractive and practical two-tone case is finished in proxylin impregnated fabric. The cover is detachable, and the hardware is brass plated. This case imparts a real professional appearance to the instrument. Ideal for home service calls, or any portable application.

MODEL TC-2P  
**\$34.50**  
Shpg. Wt. 15 Lbs.



## **3** Heathkit TV PICTURE TUBE TEST ADAPTER

The Heathkit TV picture tube test adapter is designed for use with the Model TC-2 Tube Checker. Test picture tubes for emission, shorts, and thereby determine tube quality. Consists of 12-pin TV tube socket, 4 ft. cable, octal connector, and necessary technical data. (Not a kit.)

MODEL 355  
**\$4.50**  
Shpg. Wt. 1 Lb.

## **4** Heathkit . . . CONDENSER CHECKER KIT

Use this Condenser Checker to quickly and accurately measure those unknown condenser and resistor values. All readings taken directly from the calibrated panel scales without any involved calculation. Capacity measurements in four ranges from .00001 to 1000 mfd. Checks paper, mica, ceramic and electrolytic condensers. A power factor control is available for accurate indication of electrolytic condenser efficiency. Leakage test switch—selection of five polarizing voltages, 25 volts to 450 volts DC to indicate condenser operating quality under actual load conditions. Spring-return test switch automatically discharges condenser under test and eliminates shock hazard to the operator.

Resistance measurements can be made in the range from 100 ohms to 5 meg-ohms. Here again, all values are read directly on the calibrated scales. Increased sensitivity coupled with an electron beam null indicator increases overall instrument usefulness.

For safety of operation, the circuit is entirely transformer operated. An outstanding low kit price for this surprisingly accurate instrument.

MODEL C-3  
**\$19.50**  
Shpg. Wt. 7 Lbs.



## **5** Heathkit VISUAL-AURAL SIGNAL TRACER KIT

This signal tracer is extremely valuable in servicing AM, FM, and TV receivers, especially when it comes to isolating trouble to a particular stage of the circuit under test.

This visual-aural tracer features a high gain RF input channel to permit signal tracing from the receiver antenna input clear through all RF, IF, detector, and audio stages to the speaker. Separate low-gain channel provided for audio circuit exploration. Both visual and aural indication by means of a speaker or headphone, and electron beam "eye" tube as a level indicator. Also incorporates a noise locator circuit for DC noise checks, and a built-in calibrated wattmeter (30-500 watts). Panel terminals provided for "patching" output transformer or speaker into external circuit for test purposes. Designed especially for the radio and TV serviceman. Cabinet size: 9½" wide x 6½" high x 5" deep. A real test equipment bargain.

MODEL T-3  
**\$23.50**  
Shpg. Wt. 9 Lbs.

**HEATH  
COMPANY**  
A SUBSIDIARY OF DAYSTROM INC.

**BENTON HARBOR 15, MICHIGAN**

**RADIO & TELEVISION NEWS**





MODEL HD-1

Shpg. Wt. 13 Lbs. **\$4950**

Used with a sine wave generator, the Model HD-1 will check the harmonic distortion output of audio amplifiers under a variety of conditions. Reads distortion directly on the meter as a percentage of the input signal. Operates between 20 and 20,000 cps. High impedance VTVM circuit for initial reference settings and final distortion readings. Ranges are 0-1, 3, 10, and 30 volts full scale. 1% precision resistors. Distortion scales are 0-1, 3, 10, 30 and 100% full scale. Requires only .3 volt input for distortion test.

## 1 Heathkit AUDIO ANALYZER KIT

This instrument consists of an audio wattmeter, an AC VTVM, and a complete IM analyzer, all in one compact unit.

Use the VTVM to measure noise, frequency response, output gain, power supply ripple, etc. Use the wattmeter for measurement of power output. Internal loads provided for 4, 8, 16, or 600 ohms. VTVM also calibrated for DBM units. High or low impedance IM measurements made with built-in 6KC and 60 cps generators. VTVM ranges are .01, to 300 volts in 10 steps. Wattmeter ranges are .15 mw. to 150 w. in 7 steps. IM scales are 1% to 100% in 5 steps.

MODEL AA-1

**\$5950**

Shpg. Wt. 13 Lbs.

## 2 Heathkit AUDIO GENERATOR KIT

This new Heathkit Model features step-tuning from 10 cps to 100 Kc with three rotary switches that provide two significant figures and multiplier. Less than .1% distortion. Frequency accurate to within  $\pm 5\%$ .

Output monitored on a large  $4\frac{1}{2}$ " meter that reads voltage or db. Both variable and step-type attenuation provided. Meter reads zero-to-maximum at each attenuator position. Output ranges (and therefore meter ranges) are 0-.003, .01, .03, .1, .3, 1, 3, 10 volts. Step-tuning provides rapid positive selection of the desired frequency, and allows accurate return to any given frequency.

MODEL AG-9

**\$3450**

Shpg. Wt. 8 Lbs.

## 3 Heathkit AUDIO OSCILLATOR KIT

(SINE WAVE — SQUARE WAVE)

The Model AO-1 features sine wave or square wave coverage from 20-20,000 cps in 3 ranges. It is an instrument specifically designed to completely fulfill the needs of the serviceman and high fidelity enthusiast. Offers high level output across the entire frequency range, low distortion and low impedance output. Features a thermistor in the second amplifier stage to maintain essentially flat output through the entire frequency range. Produces an excellent sine wave for audio testing, or will produce good, clean, square waves with a rise time of only 2 microseconds.

MODEL AO-1

**\$2450**

Shpg. Wt. 10 Lbs.

## 4 Heathkit RESISTANCE SUBSTITUTION BOX KIT...

Provides switch selection of 36 RTMA 1 watt standard 1% resistors ranging from 15 ohms to 10 megohms. Numerous applications in radio and TV work, and essential in the developmental laboratory.

MODEL RS-1

**\$550**

Shpg. Wt. 2 Lbs.

## 5 Heathkit AC VACUUM TUBE VOLTMETER KIT...

The Heathkit AC VTVM features high impedance, wide frequency range, very high sensitivity, and extremely wide voltage range. Will accurately measure a voltage as small as 1 mv. at high impedance. Excellent for sensitive AC measurements required by laboratories, audio enthusiasts and experimenters. Frequency response is substantially flat from 10 cps to 50 Kc. Ranges are .01, .03, .1, .3, 1, 3, 10, 30, 100, and 300 v. RMS. Total db range -52 to + 52 db. Input impedance 1 megohm at 1 Kc.

MODEL AV-2

**\$2950**

Shpg. Wt. 5 Lbs.

## 6 Heathkit CONDENSER SUBSTITUTION BOX KIT...

Very popular companion to Heathkit RS-1. Individual selection of 18 RTMA standard condenser values from .0001 mfd to .22 mfd. Includes 18" flexible leads with alligator clips.

MODEL CS-1

**\$550**

Shpg. Wt. 2 Lbs.

# Heathkit HARMONIC DISTORTION METER KIT

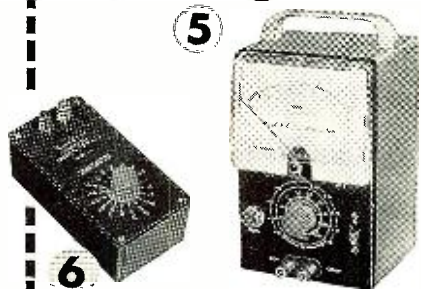
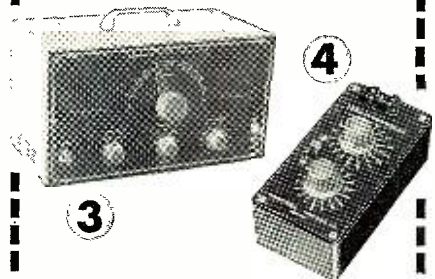
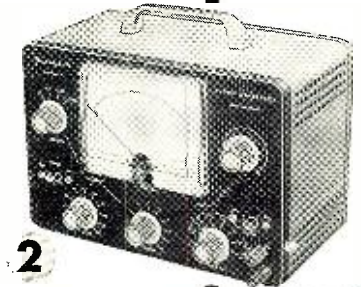
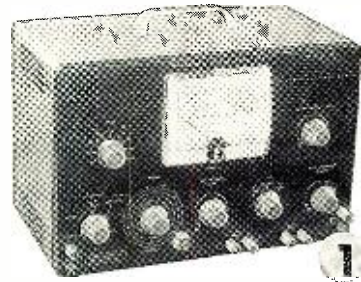

# HEATH COMPANY

A SUBSIDIARY OF DAYSTROM INC.

BENTON HARBOR 15, MICHIGAN



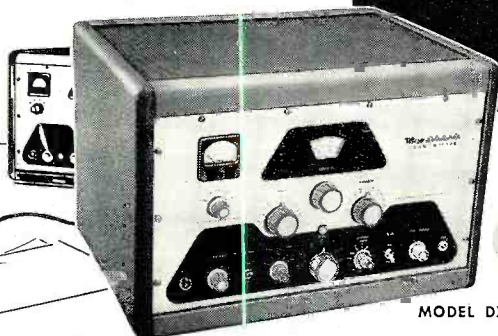

MODEL DX-100

# HEATHKIT HAM GEAR

for high quality at moderate cost

**DOLLAR VALUE:** You get more for your Heathkit dollar because your labor is used to build the kit instead of paying for someone else's. Also, the middleman's margin of profit is eliminated when you deal directly with the manufacturer.

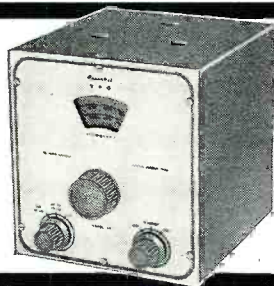

2

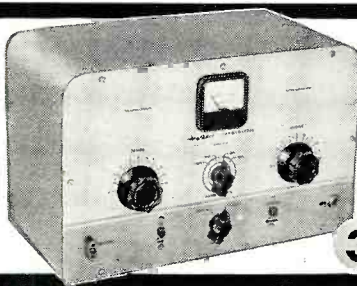

3



4

## 1 Heathkit DX-100 PHONE & CW TRANSMITTER KIT

The reception given this amateur transmitter has been tremendous. Reports from radio amateurs using the DX-100 are enthusiastic in praising its performance and the high quality of the components used in its assembly. Actual "on the air" results reflect the careful design that went into its development.

The DX-100 features a built-in VFO, modulator, and power supplies, and is completely bandswitching for phone or CW operation on 160, 80, 40, 20, 15, 11, and 10 meters. All parts necessary for construction are supplied in the kit, including tubes, cabinet, and detailed step-by-step instructions. Easy to build, and a genuine pleasure to operate.

Employs push-pull 1625's modulating parallel 6146's for RF output in excess of 100 watts on phone and 120 watts on CW. May be excited from the built-in VFO or from crystals (crystals not included with kit). Features five-point TVI suppression: (1) pi network interstage coupling to reduce harmonic transfer to the final stage; (2) pi network output coupling; (3) extensive shielding; (4) all incoming and outgoing circuits filtered; (5) inter-locking cabinet seams to eliminate radiation except through the coaxial output connector. Pi network output coupling will match 50 to 600 ohm non-reactive load. Illuminated VFO dial and meter face. Remote control socket provided.

The chassis is made of extra-strong #16 gauge copper-plated steel. It employs potted transformers, ceramic switch and variable capacitor insulation, solid silver loading switch terminals, and high-grade well-rated components throughout. Features a pre-formed wiring harness, and all coils are pre-wound.

High-gain speech amplifier for dynamic or crystal microphones, and restricted speech range for increased intelligence. Plenty of audio power reserve. Measures 20 $\frac{7}{8}$ " W. x 13 $\frac{3}{4}$ " H. x 16" D. Schematic diagram and complete technical specifications on request.

MODEL DX-100  
**\$189<sup>50</sup>**  
Shpg. Wt. 120 Lbs.

Shipped Motor Freight Unless Otherwise Specified  
\$50.00 Deposit Required on C.O.D. Orders

## 2 Heathkit VFO KIT

The Model VF-1 covers 160-80-40-20-15-11 and 10 meters with three basic oscillator frequencies. Better than 10-volt average RF output on fundamentals. Features illuminated and pre-calibrated dial scale. Cable and plug provided to fit crystal socket of any modern transmitter.

Enjoy the convenience and flexibility of VFO operation at no more than the price of crystals. May be powered from plug on the Heathkit Model AT-1 transmitter, or supplied with power from most transmitters. Measures: 7" H. x 6 $\frac{1}{2}$ " W. x 7" D.

MODEL VF-1  
**\$19<sup>50</sup>**  
Shpg. Wt. 7 Lbs.

## 3 Heathkit CW AMATEUR TRANSMITTER KIT

The Model AT-1 is an ideal novice transmitter, and may be used to excite a higher power rig later on.

This CW transmitter is complete with its own power supply, and covers 80, 40, 20, 15, 11, and 10 meters. Features single-knob bandswitching, and panel meter indicates grid or plate current for the final amplifier. Designed for crystal operation or external VFO. Crystal not included in kit. Incorporates such features as key click filter, line filter, copper-plated chassis, pre-wound coils, 52 ohm coaxial output, and high quality components throughout. Instruction book simplifies assembly. Employs a 6AG7 oscillator, 6L6 final amplifier. Operates up to 35 watts plate power input.

MODEL AT-1  
**\$29<sup>50</sup>**  
Shpg. Wt. 15 Lbs.

## 4 Heathkit ... ANTENNA COUPLER KIT

The Model AC-1 will properly match your low power transmitter to an end-fed long wire antenna. Also attenuates signals above 36 Mc, reducing TVI. 52 ohm coax. input-power up to 75 watts—10 through 80 meters—tapped inductor and variable condenser—neon RF indicator—copper plated chassis and high quality components. Ideal for use with Heathkit AT-1 Transmitter.

MODEL AC-1  
**\$14<sup>50</sup>**  
Shpg. Wt. 4 Lbs.

**HEATH COMPANY**

A Subsidiary  
of Daystrom, Inc.

**BENTON HARBOR 15, MICHIGAN**



# "AMATEUR-ENGINEERED"

## Equipment For The Ham

MODERN DESIGN: You can be sure of getting all the latest and most desirable design features when you buy Heathkits. Advanced-design is a minimum standard for new Heathkit models.

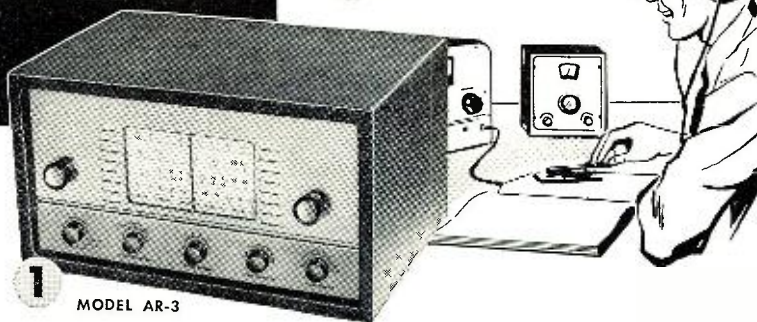

1 MODEL AR-3

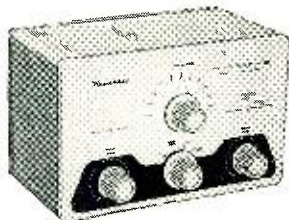

2

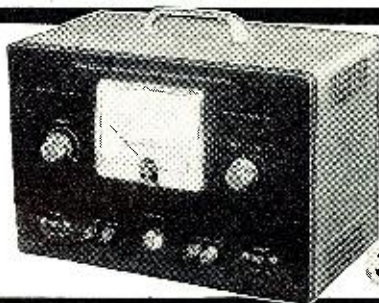

3



4



5

### 1 Heathkit COMMUNICATIONS-TYPE ALL BAND RECEIVER KIT

The new Model AR-3 features improved IF and RF performance, along with better image rejection on all bands. Completely new chassis layout for easier assembly, even for the beginner.

Covers 550 Kc to 30 Mc in four bands. Provides sharp tuning and good sensitivity over the entire range. Features a transformer-type power supply—electrical bandspread—separate RF and AF gain controls—antenna trimmer—noise limiter—AGC—BFO—headphone jacks—5½" PM speaker and illuminated tuning dial.

CABINET: Fabric covered cabinet with aluminum panel as shown. Part No. 91—shipping weight 5 lbs. \$4.50.

MODEL AR-3  
**\$27<sup>95</sup>**

Shpg. Wt. 12 Lbs.  
(Less Cabinet)

### 2 Heathkit "Q" MULTIPLIER KIT

Here is the Heathkit Q Multiplier you hams have been asking for. A tremendous help on the phone and CW bands when the QRM is heavy. Provides an effective Q of approximately 4,000 for extremely sharp "peak" or "null." Use it to "peak" the desired signal or to "null" an undesired signal, or heterodyne. Tunes to any signal within the IF band-pass of your receiver. Also provides "broad peak" for conditions where extreme selectivity is not required.

Operates with any receiver having an IF frequency between 450 and 460 Kc. Will not function with AC-DC type receivers. Requires 6.3 volts AC at 300 ma. and 150 to 250 VDC at 2 ma. Derives operating power from your receiver. Uses a 12AX7 tube, and special High-Q shielded coils. Simple to connect with the cable and plugs supplied. Measures only 4-11/16" H. x 7 7/8" W. x 4 1/8" D. A really valuable addition to the receiving equipment in your ham shack.

MODEL QF-1  
**\$9<sup>95</sup>**

Shpg. Wt. 3 Lbs.

### 3 Heathkit VARIABLE VOLTAGE REGULATED POWER SUPPLY KIT

Provides well filtered DC output, variable from zero to 500 volts at no load and regulated for stability. Will supply up to 10 ma. at 450 VDC, and up to 130 ma. at 200 VDC. Voltage or current monitored on front panel meter. Also provides 6.3 VAC at 4A. for filament. Filament voltage isolated from B+, and both isolated from ground. Invaluable around the ham shack for supplying operating potentials to experimental circuits. Use in all types of research and development laboratories as a temporary power supply, and to determine design requirements for ultimate power supply.

MODEL PS-3  
**\$35<sup>50</sup>**

Shpg. Wt. 17 lbs.

### 4 Heathkit ANTENNA IMPEDANCE METER KIT

Use in conjunction with a signal source for measuring antenna impedance, line matching, adjustment of beam and mobile antennas, etc. Will double as a phone monitor or relative field strength indicator. 100 µa. meter employed. Covers the range from 0-600 ohms. An instrument of many uses for the amateur.

MODEL AM-1  
**\$14<sup>50</sup>**

Shpg. Wt. 2 lb.

### 5 Heathkit GRID DIP METER KIT

This is an extremely valuable tool for accomplishing literally hundreds of jobs on all types of equipment. Covering from 2 Mc to 250 Mc, the GD-1B is compact and can be operated with one hand. Uses a 500 µa. meter for indication, with a sensitivity control and headphone jack. Includes prewound coils and rack. Indispensable instrument for hams, engineers, or servicemen.

MODEL GD-1B  
**\$19<sup>50</sup>**

Shpg. Wt. 4 lbs.

**HEATH COMPANY** A Subsidiary of Daystrom, Inc. **BENTON HARBOR 15, MICHIGAN**



*Heathkits*  
 PROVIDE THE  
 "CONSTRUCTIVE"  
 APPROACH TO  
**HIGH-FIDELITY**



**EASY TO BUILD:** *The assembly instructions supplied with Heathkits are so complete and detailed that anyone can assemble the kits without difficulty. Plenty of pictorial diagrams and step-by-step instructions. Information on resistor color codes, soldering, use of tools, etc. Build-it-yourself with confidence!*

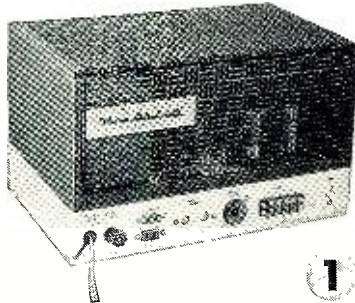

1

**1** *Heathkit* **ADVANCED-DESIGN**  
**HIGH FIDELITY** **AMPLIFIER KIT**

The 25 Watt Model W-5 is one of the most outstanding high fidelity amplifiers available today—at any price. Incorporates the very latest design features to achieve true "presence" for the super-critical listener.

Features a new-design Peerless output transformer, and KT66 output tubes handle power peaks up to 42 watts. The unique "tweeter-saver" suppresses high frequency oscillation. A new type balancing circuit results in closer "dynamic" balance between output tubes. Features improved phase shift characteristics and frequency response, with reduced IM and harmonic distortion. Color styling harmonizes with the Heathkit WA-P2 Preamplifier and the FM-3 Tuner.

Frequency response—within  $\pm 1$  db from 5 cps to 160 Kc at 1 watt. Harmonic distortion only 1% at 25 watts, 20-20,000 cps. IM distortion only 1% at 20 watts, using 60 and 3,000 cps. Output impedance 4, 8, or 16 ohms. Hum and noise—99 db below rated output. Uses two 12AU7's, two KT66's and a 5R4GY.

**KIT COMBINATIONS:**

W-5M Amplifier Kit: Consists of main amplifier and power supply, all on one chassis. Complete with all necessary parts, tubes, and comprehensive manual. Shpg. Wt. 31 lbs. Express only.

**\$59<sup>75</sup>**

W-5 Combination Amplifier Kit: Consists of W-5M Amplifier Kit listed above plus Heathkit Model WA-P2 Preamplifier Kit. Complete with all necessary parts, tubes, and construction manuals. Shpg. Wt. 38 lbs. Express only.

**\$79<sup>50</sup>**



2

**2** *Heathkit* **DUAL-CHASSIS WILLIAMSON TYPE**  
**HIGH FIDELITY** **AMPLIFIER KIT**

This is a very popular high fidelity amplifier kit that features dual-chassis type construction. The resulting physical dimensions offer an additional margin of flexibility in installation. It features the famous Acrosound TO-300 "ultra-linear" output transformer, and has a frequency response within  $\pm 1$  db from 6 cps to 150 Kc at 1 watt. Harmonic distortion only 1% at 21 watts. IM distortion at 20 watts only 1.3% at 60 and 3,000 cps. Rated power output is 20 watts. Output impedance 4, 8, or 16 ohms. Hum and noise—88 db below 20 watts. Uses two 6SN7's, and a 5V4G.

**KIT COMBINATIONS:**

W-3M: Consists of main amplifier and power supply for separate chassis construction. Includes all tubes and components necessary for assembly. Shpg. Wt. 29 lbs., Express only.

**\$49<sup>75</sup>**

W-3: Consists of W-3M Kit listed above plus Heathkit Model WA-P2 Preamplifier described on opposite page. Shpg. Wt. 37 lbs., Express only.

**\$69<sup>50</sup>**

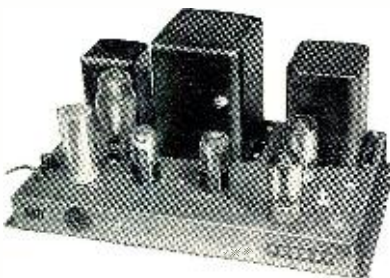

3

**3** *Heathkit* **SINGLE-CHASSIS WILLIAMSON TYPE**  
**HIGH FIDELITY** **AMPLIFIER KIT**

This is the lowest priced Williamson type amplifier ever offered in kit form, and yet it retains all the usual features of the Williamson type circuit. Main amplifier and power supply combined on one chassis, and uses a new-design Chicago output transformer. Frequency response—within  $\pm 1$  db from 10 cps to 100 Kc at 1 watt. Harmonic distortion only 1.5% at 20 watts. IM distortion at rated output, 2.7% at 60 and 3,000 cps. Rated power output is 20 watts. Output impedance 4, 8, or 16 ohms. Hum and noise—95 db below 20 watts. Uses two 6SN7's, two 5881's, and one 5V4G.

Instructions are so complete that the kit may be assembled successfully even by a beginner in electronics.

**KIT COMBINATIONS:**

W-4AM: Consists of main amplifier and power supply for single chassis construction. Includes all tubes and components necessary for assembly. Shpg. Wt. 28 lbs. Express only.

**\$39<sup>75</sup>**

W-4A: Consists of W-4AM Kit listed above plus Heathkit Model WA-P2 Preamplifier described on opposite page. Shpg. Wt. 35 lbs. Express only.

**\$59<sup>50</sup>**

**HEATH**  
**COMPANY**

A SUBSIDIARY OF DAYSTROM INC.

**BENTON HARBOR 15, MICHIGAN**

**RADIO & TELEVISION NEWS**



ATTRACTIVELY STYLED: *Heathkit high fidelity instruments are not only functional, but are most attractive in physical design. Such units as the preamplifier and the W-5 main amplifier are designed for beauty as well as performance. They blend with any room decor and are the kind of instruments you will be proud to own.*



*enjoy....*  
**THE VERY BEST  
 IN AUDIO WITH  
 "BUILD-IT-YOURSELF"  
 HEATHKITS**

**1** *Heathkit* HIGH FIDELITY  
**PREAMPLIFIER KIT**

This outstanding preamplifier is designed specifically for use with the Heathkit Williamson type amplifiers. It completely fulfills the requirements for remote control, compensation and preamplification, and exceeds even the most rigorous specifications for high fidelity performance.

Features five separate switch-selected input channels (2 low level and 3 high level), each with its own input control. Full record equalization with four-position turnover control and four-position rolloff control.

Output jack for tape recorder — separate bass control with 18 db boost and 12 db cut at 50 cps. — treble control offering 15 db boost and 20 db cut at 15,000 cps — special hum control to insure minimum hum level — and many other desirable features. Overall frequency response (with controls set to "flat" position) is within 1 db from 25 cps to 30,000 cps. Will do justice to the finest available program sources. Beautiful satin-gold finish.

Power requirements from the Heathkit Williamson type high fidelity amplifier — 6.3 VAC at 1 amp., and 300 VDC at 10 Ma. Uses two 12AX7's and one 12AU7.

MODEL WA-P2  
**\$1975**  
 Shpg. Wt. 7 Lbs.

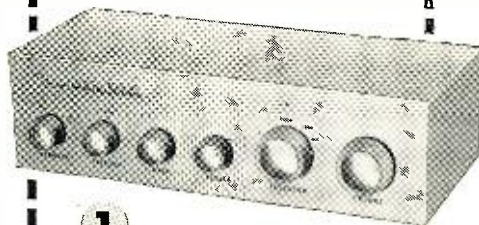

**1**

**2** *Heathkit* 20-WATT HIGH FIDELITY  
**AMPLIFIER KIT**

This Heathkit Model offers you the least expensive route to high fidelity performance. Frequency response is  $\pm 1$  db from 20-20,000 cps. Features full 20 watt output using push-pull 6L6's, and incorporates separate bass and treble tone controls. Preamplifier and main amplifier are built on the same chassis. Four switch-selected compensated inputs and separate bass and treble tone controls provide all necessary functions at minimum investment. Features miniature tube types for low hum and noise.

Uses 12AX7, two 12AU7's, two 6L6G's and a 5V4G. A most interesting "build-it-yourself" project, and an excellent hi-fi amplifier for home use. Well suited, also, for public address applications because of its high power output and high quality audio reproduction. Another Heathkit "best-buy" for you!

MODEL A-9B  
**\$3550**  
 Shpg. Wt. 23 Lbs.



**2**

**3** *Heathkit* 7 - WATT  
**AMPLIFIER KIT**

The redesigned Model A-7D features a new type output transformer for tapped screen operation, and provides improved sensitivity, reduced distortion, and increased power output.

The full 7-watt output of the Model A-7D is more than adequate for normal home installations. Frequency characteristics are  $\pm 1\frac{1}{2}$  db from 20 to 20,000 cps. Potted output and power transformers employed. Push-pull output — detailed construction manual — top quality parts — high quality audio without great expense. Output transformer tapped at 4, 8, and 16 ohms. Bass and treble tone controls provided on the front chassis apron.

MODEL A-7D  
**\$1695**  
 Shpg. Wt. 10 Lbs.



**3**

Model A-7E: Provides a preamplifier stage with two switch-selected inputs and RIAA compensation for variable reluctance or low level cartridges. Preamplifier built on same chassis as main amplifier. Model A-7E. Shipping weight 10 lbs. \$18.50.

**HEATH  
 COMPANY**

A SUBSIDIARY OF DAYSTROM INC.

**BENTON HARBOR 15, MICHIGAN**





MODEL FM-3

Shpg. Wt. 7 lbs. **\$24<sup>50</sup>**  
(with cabinet)

The new Heathkit Model FM-3 features tremendous circuit improvements and brand new physical design. Sensitivity is better than 10  $\mu$ v. for 20 db of quieting, and it employs a completely modern tube line-up for high gain and stable operation. Incorporates its own power supply, and has provision for low-level or high-level output at low impedance.

The attractive Model FM-3 matches the WA-P2 Pre-amplifier in color, styling, and physical size.

Incorporates automatic gain control, a highly stabilized oscillator, and illuminated tuning dial. Educational treatment of construction manual simplifies assembly for the newcomer to electronics. *IF* and *ratio* transformers are *pre-aligned*, and the front-end tuning unit is pre-assembled and aligned. Uses 6BQ7A as a cascode type RF stage, 6U8 oscillator-mixer, two 6CB6's as IF amplifiers, a 6AL5 ratio detector, a 6C4 audio amplifier, and 6X4 rectifier.

# Brand New HEATHKIT HIGH-FIDELITY FM TUNER KIT

## Features

- ▶ Brand New, Modern FM Circuit Using Latest Type Miniature Tubes.
- ▶ Low-Noise Cascode RF Stage—Two IF's—Ratio Detector—Stage of Audio.
- ▶ Extremely Good Sensitivity and Band-Pass for Outstanding Performance.
- ▶ Strikingly Attractive Satin-Gold Finish to Match Heathkit Model WA-P2 Pre-amplifier.
- ▶ Compact Physical Dimensions for Most Pleasing Appearance and Increased Circuit Efficiency.

## HEATHKIT BROADCAST-BAND RECEIVER KIT

Build your own radio receiver with confidence, even if you are a beginner. Complete instructions supplied.

Features transformer-type power supply, high-gain miniature tubes, built-in antenna,  $5\frac{1}{2}$ " speaker, and planetary tuning from 550 Kc to 1500 Kc. Adaptable for use as AM Tuner and phono amplifier. Educational treatment of the construction manual helps the beginner learn about radio circuits and parts as he builds.

**CABINET:** Fabric covered plywood cabinet with aluminum panel as shown. Part 91-9, Shpg. Wt. 5 lbs., \$4.50.



MODEL BR-2

**\$17<sup>50</sup>** Less Cabinet  
Shpg. Wt. 10 lbs.

Are you on our mailing list? If not—how about sending us your name?

Phone WALNUT 5-1175

to HEATH COMPANY  
A Subsidiary of Daystrom, Inc.  
BENTON HARBOR 15,  
MICHIGAN

from \_\_\_\_\_

(PLEASE PRINT)

SHIP VIA  
 Parcel Post  
 Express  
 Freight  
 Best Way

QUANTITY	ITEM	MODEL NO.	PRICE

NOTE: ALL PRICES SUBJECT TO CHANGE WITHOUT NOTICE.  
Enclosed find ( ) check ( ) money order for \_\_\_\_\_ Please ship C.O.D. ( ) postage enclosed for \_\_\_\_\_ pounds.  
On Express orders do not include transportation charges—they will be collected by the express agency at time of delivery.  
ON PARCEL POST ORDERS include postage for weight shown. ORDERS FROM CANADA and APO's must include full remittance.

**HEATH COMPANY** A Subsidiary of Daystrom, Inc. **BENTON HARBOR 15, MICHIGAN**



# Transistorized Audio Amplifier

**A** COMPACT, transistorized audio amplifier designed to operate a speaker in class B push-pull, transformer-coupled, ¼ watt power output is easy to build and relatively inexpensive.

Transformer coupling between the transistor amplifier stages provides impedance matching and allows the use of fewer stages for the same over-all gain than RC interstage coupling.

The circuit itself is built around three of the General Electric 2N107 junction transistors of the "p-n-p" type. The amplifier is powered by four 1½ volt penlite cells and operates in push-pull class B. Frequency response is from 100 to 8000 cps with an over-all power gain in excess of 50 db.

The three transistors are connected in a grounded-emitter type circuit which provides sufficient power to operate a good quality 4" to 6" PM speaker with a 3.2 ohm voice coil.

The transformers required for this construction are of the type especially designed for transistor circuitry. An important feature of such components is their high inductance and low d.c. resistance. Input impedance of this circuit is 1000 ohms. For high impedance inputs a matching transformer is required. For magnetic inputs a preamplifier is needed.

Since a feedback loop is employed, the necessary precautions in regard to

phasing must be employed. Follow the color coding of the transformers carefully. Should oscillation occur after completion, reverse the black and green wires of the output transformer. The transformers, which are the only special components required to build this amplifier, are manufactured by Argonne Electronics Mfg. Co.

For those who wish to avoid the trouble of shopping for individual components, Lafayette Radio, 100 Sixth Avenue, New York 13, New York has a kit, Model KT-69, available for \$17.95.

The primary purpose of this kit is for the experimenter, student, or anyone who wants to obtain some working knowledge of transistor operation. For all practical purposes, considering the price, a vacuum tube-type power amplifier would be more advisable. -50-

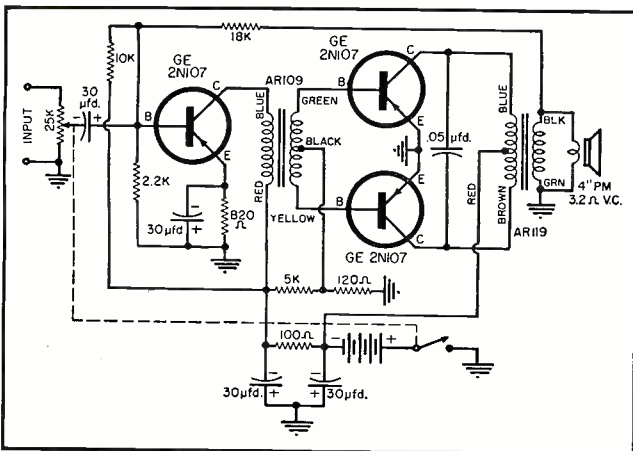
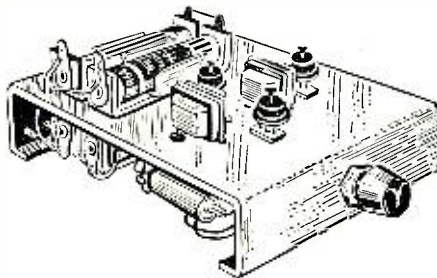

↑ Over-all view of the transistorized audio amplifier. Here, it is built breadboard style on a chassis measuring 3" x 4" x 1", although any arrangement of parts will do.



← Complete schematic diagram of audio amplifier. It uses three of the new G-E 2N107 transistors and two specially-designed transistor type transformers.

## THIRTY-SECOND BOARD of DIRECTORS and OFFICERS RETMA 1955-56



did you read

Mac's Service Shop  
December Issue, Page 74  
on magnetic shielding?

"Magnetic shielding is becoming more important every day.

"Golly, that spot can't be moving more than a sixty-fourth of an inch if it moves at all," Barney marvelled.

On the other hand, if the scope is to be used around strong fields, a shield is a real necessity; furthermore, if the scope owner is a darned crank, as I cheerfully admit I am, who does not want anything influencing the motion of that spot except the signal fed into the amplifiers, a shield is worth its cost in personal satisfaction.

Here's how to get Fernetec Scope Shield for

**HEATH KIT Model O-10  
FERNETEC CRT SHIELD**

\$8.94 P. P. Prepaid

Also low intensity shield can be furnished for inside of other shield at slight additional cost—both shields for \$11.04 P. P. Prepaid. Complete with instructions for installation.

Send check or money order with order; Sorry no C.O.D.s.

**MAGNETIC SHIELD DIVISION OF  
PERFECTION MICA COMPANY**

20 N. WACKER DR., SUITE 1829-A  
CHICAGO 6, ILLINOIS



Fernetec Shields, Sheets 15" x 30" available for bending around transformers or motors \$10.50 each. Fernetec Shields, Sheets 30" x 30" for hi-fi deck plates \$16.50 each.

Distributors inquiries invited.

In near future . . . a complete line of CRT Shields for all popular scopes. Also, Fernetec Shields for thousands of electric and electronic applications.





By JAN SYRJALA

*An engineering evaluation of resonance indicators for FM and AM receivers and some conclusions regarding their use.*

WITH the steady increase in the interest in high-quality audio systems that has developed during the past few years, the author is frequently asked to evaluate and compare equipment for the benefit of confused music lovers.

One commonly-asked question concerns the relative merits of the various types of tuning indicators. It is difficult to obtain maximum FM performance from an FM receiver if there is no adequate method of determining whether or not the set is tuned in "on the nose." It must be understood that the lack of a tuning indicator does not mean that a tuner is of poor quality or cheap, it merely means that it is more difficult to insure consistent top performance from such a system.

Two general classes of tuning indicators are available: electron-ray tubes and meters. This article will describe and evaluate the two types in the hopes that the reader will obtain a fuller appreciation of the necessity for exact tuning and an understanding of how it can be achieved.

Although the author, like many others in the field, had many theories based on casual observations of tuning indicators, it was felt that some experimentation was necessary in order to gather quantitative data with which to evaluate such devices. In order to gather the desired information, a

representative tuner had to be selected. A Pilot Model AF-860 was selected as the "guinea pig." It was chosen since it is equipped with an effective tuning meter and is in the medium price class. Just as important are its circuit features which make it possible to acquire a great variety of performance data: FM reception, wide-band and conventional AM reception, automatic frequency control on FM, continuously variable by means of a front panel knob, low oscillator drift, and a sensitivity of 2 microvolts for 20 db of quieting.

In order to make comparisons under identical signal conditions, it was necessary, of course, that all the indicators be connected to the same receiver and operated simultaneously. To accomplish this, two sockets on flexible leads were installed for the operation of two electron-ray indicators and the power supply was augmented

Phosphor decay rate for tuning eye tubes.

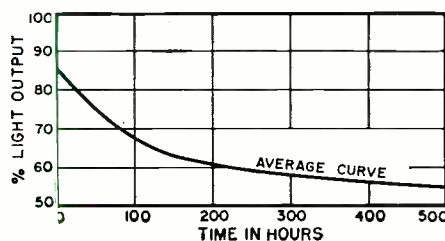

slightly. The two tuning "eyes" which were considered were the 6E5 and the 6AL7. There was no problem with the 6E5; however, the 6AL7 required higher voltage than that available from the receiver's power supply so an additional rectifier tube and filter capacitor were installed. The meter-type tuning indicator is an integral part of the tuner and was left "as is."

**Indicator Types**

The 6E5, one of the most common types of electron-ray indicators, is found in many AM and some FM receivers. When operating, its screen or "target" glows, showing a disc of green light with a dark center. The latter is caused by an internal shield that blocks off the light from the heater element of the tube. A pie-shaped wedge of darkness or shadow area on the green disc varies in width with the strength of the incoming signal.

The 6AL7 is very different in construction, appearance, and use. It was developed by *General Electric Company* in 1945 out of the realization that if electron-ray indicators were to be used in FM receivers a more suitable type would be required. First of all, the 6AL7 is actually a double indicator, whereas the 6E5 indicates only one signal voltage, usually the a.v.c voltage in AM receivers or the first limiter grid voltage in FM sets. The 6AL7 indicates not only either of these signals but, in addition, the voltage at the discriminator output in FM receivers. This latter information is rather important for tuning FM sets correctly.

The 6AL7 displays two side-by-side rectangular fluorescent patterns. These function in such a manner that the entire upper half of the pattern moves according to the voltage at the discriminator output; the other side is fixed by being at ground potential and serves for comparison with the adjacent pattern. The principle behind the comparison of the two patterns lies in the fact that when the receiver is properly tuned to a station the d.c. voltage at the discriminator is zero. Therefore, when the movable pattern is aligned with the fixed pattern (which is at zero potential) we know that the set is properly tuned.

The third form of tuning indicator, the meter, employs minute FM discriminator or AM a.v.c. currents from the discriminator output in FM or the a.v.c. circuit in AM, which may vary in magnitude and polarity with tuning. These currents deflect a highly sensitive pointer which indicates relative or absolute changes in the circuit currents. In FM receivers it is advantageous to use a meter with its zero indication in the center of the scale, because the discriminator output current is zero with correct tuning and changes polarity as the set is tuned through the proper setting. The meter is thus capable of indicating these changes. It is possible to use an ordinary meter that has the zero mark



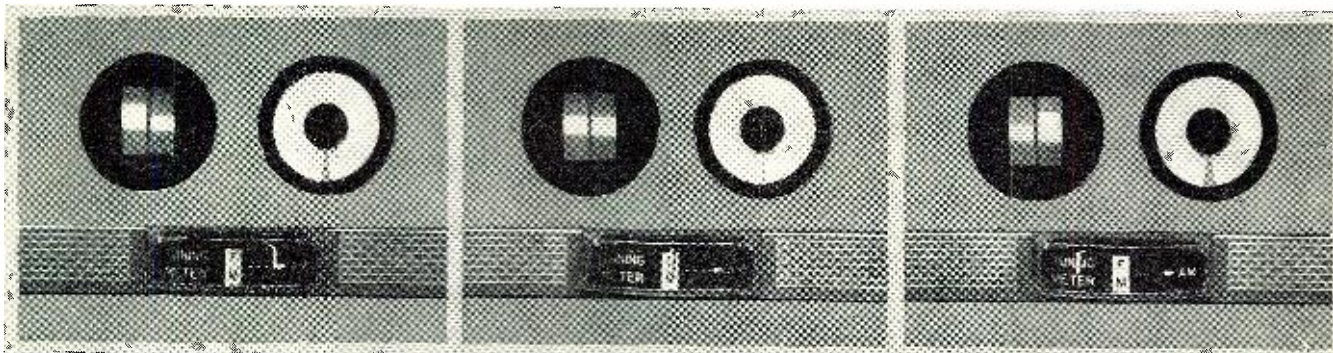

Fig. 1. Three basic types of indications over an entire FM tuning process during which station is off, "on-the-nose," then off again.

at either end of the scale, but this obviously tells only half the tuning story.

Fig. 1 will provide the reader with an insight into the operation of the three basic types of tuning indicators. These photographs show the entire FM tuning process of the indicators when "off-station," "on-station," and "off-station" once more.

Fig. 2 shows a similar tuning sequence but for AM reception. In this case the photos show (from left to right) a severe case of mistuning, a slight case of "off-station," and finally, "on-station" reading. Here the reader should observe that the meter varies or is deflected to one side of its scale only. This is because AM tuning indications are taken from the a.v.c. voltage which is always negative. In the case of the 6AL7, note that the height of the image indicates the state of tuning.

The most serious problem encountered with tuning "eyes" is the decay of the fluorescent screen material. This phosphor de-activation is due to heating effects. There are two sources of heat. The first is the thermal radiation emanating directly from the heater-cathode. The second and more destructive heat is generated by the impact of the electron stream on the phosphor surface. This is quite unavoidable since it is this very bombardment of electrons which produces the visible indicating pattern.

The brilliance and sensitivity of tuning "eyes" vary with the target voltage. In the case of the 6E5, reducing the target voltage by one-half roughly doubles the sensitivity, while with the 6AL7 tube the sensitivity remains relatively constant through a rather

wide range of applied target voltages.

At this point one might well ask what are the advantages of using a tuning eye of some form in lieu of a meter. The advantage of the tuning eye lies in its high input resistance which permits the eye tube to be connected almost anywhere in a circuit without disturbing that circuit. In addition, the initial cost of an eye tube is low when compared with a meter.

Like a small child eating his vegetables first and saving the meat for last, we shall now embark on the matter of the tuning meter. It has no filament or target to deteriorate. It does draw a small amount of power from the circuit, although it is too small to be of consequence. One decided advantage is its long-term stability. Once it is calibrated, nothing short of a hammer blow disturbs its accuracy.

The aural tuning of AM receivers is fairly easy because the listener can compare the intensity of the background noise with that of the signal. FM background noise is generally present only when the receiver is excessively out of tune, unless the signal strength is such that the receiver is not limiting properly. Furthermore, the change of tone quality in an out-of-tune FM receiver is not quite as noticeable as it is on an AM set. When tuning an FM set by ear, one must listen very carefully to the extreme ends of the audio spectrum for signs of degradation, usually in the form of poor transients and intermodulation distortion. If the program has distorted highs or lacks lows, as in the case of many remote transmissions or poor recordings, it is very difficult to tune the station by ear alone.

When an FM tuner drifts appreciably

during the initial warm-up period, distortion of the program material sets in. The onset of this distortion can be so slow that the listener is not immediately conscious of it, although it will grow on him. Drift is easily observed on a tuning meter and with the aid of the latter is easily corrected. Indeed, it becomes possible, with a little experience, to "off-tune" the set with the meter in such a direction that the tuner drifts into perfect tuning after the warm-up period, instead of out of it. The signals will sound fuzzy at the start, but will soon clear up.

In the course of experimenting with the AF-860 tuner, we found that there is a surprising difference in the facility with which FM stations can be tuned in, using the indicators mentioned. For example, in order to locate center frequency with a 6E5, one oscillates the tuning knob in gradually decreasing increments until the eye shows itself to be most completely closed. Receiver drift will cause the eye to open but will not indicate the direction in which the tuning knob must be turned to compensate for the error. The 6AL7 is more helpful in this regard. When tuning with a meter, adjustment is simpler and more positive in that one can see immediately both the direction and the degree of the drift. There is no need to wiggle the tuning knob or to try to align the ragged edges in an "eye."

To summarize the advantages of the meter type tuning indicator: the meter indicates direction and amount of mistuning by a relatively large deflection, the meter has a specific calibrated point for indicating correct tuning, and the life of the meter is well in excess of the life of the tuner itself. -50-

Fig. 2. Tuning sequence for an AM receiver as discussed in text. From left to right, badly mistuned, "off-station," and "on-station."

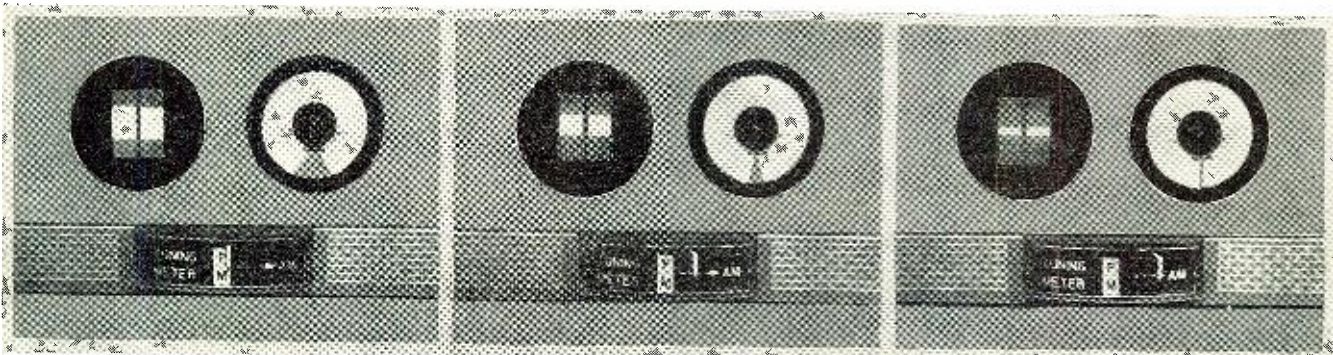



# BUILT TO LAST

**WHEATLAND TUBE**  
HOT DIP GALVANIZED  
ELECTRIC WELD STEEL TUBING

Entire tube is dipped in molten zinc for complete rust protection inside and outside

**HOT DIP GALVANIZING MAKES  
MAST RUST RESISTANT!**

**WHEATLAND TUBE**—Heavy gauge steel tubing with an extra heavy coating of prime western zinc that actually adds weight to the TV mast.

**WHEATLAND TUBE IS CORROSION PROOF**—Tube is completely dipped in huge tank of molten zinc that coats inside and outside with layers of pure zinc that are actually fused to surfaces of zinc—sealing out destructive weather elements.

**WHEATLAND TUBE CHIP PROOF AND SCRATCH PROOF**—If galvanized coating is scratched, surrounding zinc actually "heals the wound". Hot dip galvanizing automatically protects mast and base.

PRE-GALVANIZED STRIP TUBING FOR TV MASTS  
gives you quality at a popular price!



## WHEATLAND TUBE COMPANY

BANKERS SECURITIES BUILDING • PHILADELPHIA 7, PA. • MILLS: WHEATLAND, PA. • DELAIR, N.J.



**BETTER SOUND!**

Today's lowest-cost, acoustically-perfect housing for 1- or 2-way speaker systems!

Takes 12" or 15" woofer and any size or type tweeter, up to 5" x 12", rectangular or round. All necessary adapters included.

Direct mounting of speakers on sturdy, solid wood. Full front radiation, assures "come alive" clarity and brilliance.

Unique internal horn design; rear wave loading through special "extended horn" arrangement. Full, clean bass response.

Cabinet resonances virtually eliminated by correct proportioning. Ample acoustical insulation. Solid plywood sides, reinforced.

Dimensions: 36" wide x 18 3/4" deep x 32" high. Side length: 26". Weight: 45 lbs.

**RIVER EDGE**

**KIT NO. 900**  
HORN LOADED  
CORNER ENCLOSURE

Full grille cloth front!

**BETTER VALUE!**

Ready for instant assembly! We supply everything you need but the screwdriver...

3/8" plywood and lumber, cut and machined to exact size; full acoustical insulation; hardware; glue; wood filler; sandpaper ... everything!

In fact... you'll even find a full grille cloth front; full solid wood side panels, and decorative moulding...

every part engineered for foolproof, accurate assembly... every joint located and marked, to fit perfectly and stay that way...

and, on one sheet... all the instructions you need, graphically illustrated and described in simplest, step-by-step terms.

**COMPLETE \$23<sup>96</sup> net**

**Mail today for complete catalogue!**

To: RIVER-EDGE SALES CORP. Dept. RT-16  
Port Washington, N. Y.

Send River-Edge Catalogue to:

Name \_\_\_\_\_

Address: \_\_\_\_\_

City: \_\_\_\_\_ Zone: \_\_\_\_\_ State: \_\_\_\_\_

A Quality Endorsed Product of the British Industries Group

**Mac's Service Shop**  
(Continued from page 73)

bill," Mac suggested. "Quite likely the original instructions accompanying the set mentioned this, but the first thing any good red-blooded American does with instructions is to throw them away; so a reminder may help."

"Say, Mac," Barney commented as he placed the corrected bill and the note on the set, "I was just wondering if we shouldn't build up a variable-voltage transformer that would allow us to go 'way on down below the 90 volts minimum we can get out of our isolation transformer. Every now and then I wish I could start with a very low line voltage and come up a little step at a time to the full 117 volts."

"When would you need something such as that?" Mac asked with interest.

"Well, for instance, the other day I got a set which the owner said burned out new tubes as fast as he could plug them in. A resistance check across the heater string with good tubes in the sockets revealed nothing wrong; but sure enough when I plugged it in, two tubes went out before I could unplug it. As I suspected and later proved, one of the tubes developed a cathode-to-heater short very shortly after the heater started to warm up; and this allowed the full line voltage to appear across two of the tubes and burned them out. Unfortunately, neither of the tubes burned out was the one with the trouble-causing short; so it just stayed in there all ready to take care of the heaters of the next pair of tubes put into those empty sockets. Now I feel sure that if I could have started with a very low voltage, say twenty or thirty volts, and gradually raised that voltage a few volts at a time, I could have triggered this condition at a voltage level that still would not have been sufficient to burn out the heaters."

"I'm convinced you could, and I'm delighted to see you using the old noggin," Mac applauded. "However, I believe we can satisfy your needs without going to the expense of a new transformer."

"Yeah?" Barney doubted.

"As I see it, all we have to do is take an old tube base and run a couple of leads from its heater prongs to an ordinary a.c. receptacle," Mac explained. "Then, whenever we need a very low a.c. voltage to power a receiver, we simply plug the tube base into a socket on the tube checker and plug the receiver into the a.c. receptacle. With the heater voltage selector on the tube tester, we can have practically any voltage we want from 1 volt right on up to the full line voltage. The fuse on the tube tester will prevent our damaging it with any unexpected overload. Since the tube checker uses a variable resistor in series with the transformer primary to serve as a line-voltage adjustment, the drop across this resistor provides our



lash-up with rather poor voltage regulation. This will serve as an advantage in that any sudden increase in current demand will produce a voltage drop that will tend to prevent serious damage."

"Nothing brings out the inventive genius of a Scotsman like the alarming prospect of having to put out some money," Barney said admiringly. "That will work fine, and I'll build up that little adapter right now while we have time. Incidentally, while I realize a breathing spell like this is bad for business, I must admit I rather enjoy seeing the shop all caught up for once. Seeing the bench all cleaned off this way makes me feel kind of free and easy and relaxed, and I get a kick out of your having time to do some serious talking."

"You know something?" Mac confessed with a twinkle in his eye. "This probably convicts me of being a very low-pressure businessman and a worse Scotsman, but I enjoy it too!" —30—

### SIMPLE SIGNAL TRACER

By VICTOR SCHNEIDER

THE signal tracer described here is a reliable, inexpensive, and handy device for the radio service technician or the hobbyist who does not want to have to rely on one of the larger, more elaborate test instruments for the job.

The original model was built into a soft plastic cigarette case because it was easy to obtain and holes in the case could be made with a pair of scissors. Most of the parts required were found lying around in the spare parts box. For the rectifier, almost any kind of germanium diode will do. However, for best results, the use of a high-efficiency type such as the 1N34, 1N56, or at a lower price, the CK706, is recommended.

This tracer has one novel feature that makes it different from others of its type, which usually have no provision for tracing a demodulated radio signal. An extra jack is provided which is used to bypass the crystal. All parts shown on the circuit diagram are standard and easily obtainable.

The testing points for a radio using octal tubes with grid caps are: the grid cap on the converter tube, r.f. amplifier, and sometimes the preamplifier, and pin 3, which is generally connected to the plate. For sets using octal tubes without caps, the points are: pin 3 or 8 to the plate circuit, and pin 2, 4, or 5 for the input circuit.

For a set using miniature tubes, the test points are: pin 2, 3, or 6 for battery portables, and pin 1, 5, 6, or 7 for table models.

Considering the small amount of time and money involved in building this compact unit, it performs amazingly well and is a valuable test bench accessory.

Schematic diagram of the inexpensive signal-tracing probe described here.

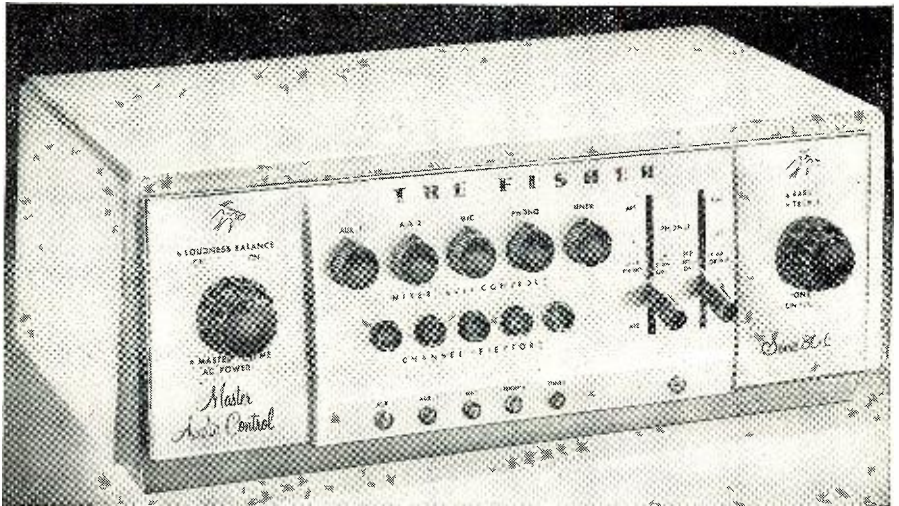
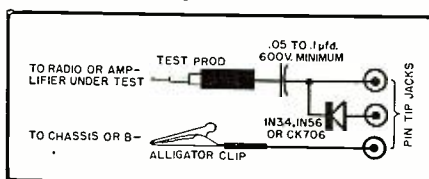

**"Breathtaking!"** — EDWARD TATNALL CANBY

# THE FISHER

## Master Audio Control

SERIES 80-C

"STARTLINGLY DIFFERENT," says Edward Tatnall Canby, *Audio Magazine*. "Has everything, at a very reasonable price for top-quality hi-fi equipment. The easiest to read and operate I've ever seen. The specs on performance are breathtaking and the over-all quality of its electrical operation is pretty closely comparable to that of a professional broadcast console control board. This is the current standard for really hi-fi operation of controls in the home. Hum, distortion, *et al* are so low as to be inaudible and mostly unmeasurable in the lab. And all this, mind you, in the middle price range."

Chassis Only, \$99.50 • Mahogany or Blonde Cabinet, \$9.95

### Remarkable Features of THE FISHER 80-C

- Professional, lever-type equalization for all current recording characteristics.
  - Seven inputs, including two Phono, Mic and Tape.
  - Two cathode-follower outputs.
  - Complete mixing and fading on two, three, four or five channels.
  - Bass and Treble Tone Controls of the variable-crossover feedback type.
  - Accurately calibrated Loudness Balance Control.
  - Self-powered.
  - Magnetically shielded and potted transformer.
  - DC on all filaments; achieves hum level that is inaudible under any conditions.
  - Inherent hum: non-measurable. (On Phono, 72 db below output on 10 mv input signal; better than 85 db below 2v output on high-level channels.)
  - IM and harmonic distortion: non-measurable.
  - Frequency response: uniform, 10 to 100,000 cycles.
  - Separate equalization and amplification directly from tape playback head.
  - Four dual-purpose tubes, all shielded and shock-mounted.
  - Separate, high-gain microphone preamplifier.
  - Push-Button Channel-Selectors with individual indicator lights and simultaneous AC On-Off switching on two channels (for tuner, TV, etc.).
  - Master Volume Control plus 5 independent Level Controls on front panel.
  - 11 Controls plus 5 push-buttons.
  - Three auxiliary AC receptacles.
- SIZE: Chassis, 12¾" x 7¾" x 4¼" high. In cabinet, 13-11/16" x 8" x 5¼" high. Shipping weight, 10 pounds.

Prices Slightly Higher West of the Rockies

WRITE TODAY FOR COMPLETE SPECIFICATIONS

FISHER RADIO CORP. • 21-23 44th DRIVE • L. I. CITY 1, N. Y.



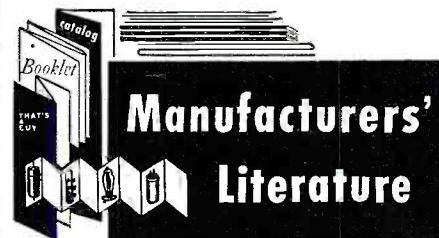

#### SENSITIVE RELAYS

A comprehensive catalogue on high-speed and sensitive relays is now available on request from the Electronics Division of *Iron Fireman Mfg. Co.*, 2838 S. E. 9th Ave., Portland 2, Ore.

The 12-page catalogue describes relays especially designed for precision aircraft electronic equipment conforming to highest military ratings in quality control.

Operational charts and instructions for their use are included. The charts provide a means of predicting the behavior of special values of coil resistance and other operating characteristics. Dimensional and wiring diagrams are also shown in this publication.

#### TUBES FOR INDUSTRY

The Tube Division of *Radio Corporation of America*, Harrison, N. J., has just released a new technical booklet covering the subject of receiving-type tubes for industry and communications.

The 20-page booklet contains technical data on 130 small industrial tubes including "Special Red" tubes, premium-tubes, pencil-type tubes, computer tubes, glow-discharge tubes, small thyratrons, low-microphonic amplifier tubes, and other special types. In addition, a chart is included listing RCA types intended for government end use only.

The booklet is priced at 20 cents a copy and is available from local tube distributors or from the Commercial Engineering Dept. of the Tube Division.

#### GROUND ANCHOR DATA

*Laconia Malleable Iron Company*, Laconia, N. H., is in production on a new ground anchor which has been developed by *Clevett Engineering Laboratory* of 34 Harwood Road, Natick, Mass.

Details on this new device are included in a four-page booklet which lists the outstanding features of the anchors, specification and installation data, and illustrated applications for the devices. An insert data sheet illustrates, by means of cartoon characters, how the anchor grounds should be installed.

Write the manufacturer for a copy of this data sheet.

#### TEST EQUIPMENT FLYER

*Moss Electronic Distributing Co., Inc.*, 3849 Tenth Ave., New York 34, N. Y., is currently offering copies of its four-page brochure covering a line of test instruments for the service technician.

This two-color flyer lists v.o.m.'s, "super meters," tube testers, CRT tube



AN EXCEPTIONAL, NEW THIRTY-WATT AMPLIFIER • HANDLES SIXTY-WATT PEAKS!

# New! And Fabulous!

THE   
FISHER

## 30-Watt Amplifier

MODEL 80-AZ

**A**NOTHER FISHER FIRST — our great new 30-watt amplifier with *PowerScope*, a Peak Power Indicator calibrated in watts to show instantly the peak load on your speaker system. The new FISHER 80-AZ Amplifier is the first with a positive indicator to prevent voice coil damage. The Model 80-AZ is magnificent in appearance and quality.

#### Incomparable Features of THE FISHER Model 80-AZ

- High output — less than 0.5% distortion at 30 watts; less than 0.05% at 10 watts. Handles 60-watt peaks. ■ Intermodulation distortion less than 0.5% at 25 watts and 0.2% at 10 watts. ■ Uniform response 10 to 50,000 cycles; within 0.1 db from 20 to 20,000 cycles. ■ Power output is constant within 1 db at 30 watts, from 15 to 35,000 cycles. ■ Hum and noise level better than 96 db below full output! ■ Three separate feedback loops for lowest distortion and superior transient response.
- Unique cathode feedback circuit for triode performance with the efficiency of tetrodes. ■ Output transformer has interleaved windings and a grain-oriented steel core. ■ Three Controls: *PowerScope*, *Z-Matic* and Input Level. ■ Handsome, brushed-brass control panel (with sufficient cable for built-in installations.) ■ Tube Complement: 1—12AT7, 1—12AU7A, 2—EL-37, 1—5V4-G, 1—*PowerScope* Indicator, 1—Regulator. ■ 8- and 16-ohm outputs. ■ SIZE: 15½ x 4¼ x 6¾" high. WEIGHT: 22 lbs.

**Price Only \$99.50**

*Price Slightly Higher West of the Rockies*

WRITE TODAY FOR COMPLETE SPECIFICATIONS

**FISHER RADIO CORP., 21-23 44th DRIVE • L. I. CITY 1 • N. Y.**



checkers, "Genometers", etc. Copies of this publication are available from the company on request.

#### SOLAR CAPACITORS

*Solar Mfg. Corp.*, E. 46th St. and Seville Ave., Los Angeles, Calif., has recently released a new 24-page catalogue which gives application data, capacity-per-size designations, specifications, and curves for a complete line of ceramic capacitors.

The line includes disc types in bypass, high voltage, temperature-compensating and special styles, feed-through and trimmer types, and tubular types in bypass and temperature-compensating styles. An extensive line of printed networks is also catalogued, together with data on piezoelectric elements.

Requests for copies of this catalogue must be made on company letterhead.

#### MICROMINIATURE RELAYS

*General Electric Company*, Schenectady 5, N. Y., is offering a four-page bulletin describing its recently-developed microminiature relay for electronic applications which demand minimum size and weight.

The publication, designated GEA-6346, describes the relay and lists specifications for both the standard and the current-sensitive models. The hermetically-sealed relay weighs .35 ounce in the standard model and .4 ounce in the current-sensitive model.

#### AN CONNECTORS

In order to assist engineers to quickly specify AN connectors for a wide range of applications, *The Deutsch Company* of 7000 Avalon Blvd., Los Angeles 3, California is currently offering a new wall chart which measures 22" x 27".

Items shown for ready reference on the chart include selection of the right connector, data on number of contacts, contact size, voltage rating, creepage distance, and particularly spacing information.

The section on specifying complete connector assemblies includes data on insert insulation materials and shell finishes.

Address requests for the chart direct to Mr. R. H. Cumins of the company.

#### VIBRATION MEASUREMENT

*General Radio Company*, 275 Massachusetts Ave., Cambridge 39, Mass. has just issued a new 64-page booklet entitled "Measurement of Vibration."

The text covers the meaning of vibration terms, description of vibration-measuring instruments, procedures, typical examples, and interpretation of results. A short section is devoted to the human response to mechanical vibration.

Since unwanted vibration is a plague but since there are also desirable and useful types of vibration, the first step in understanding the phenomenon lies in the measurement of vibration. Copies of the booklet are free. -30-

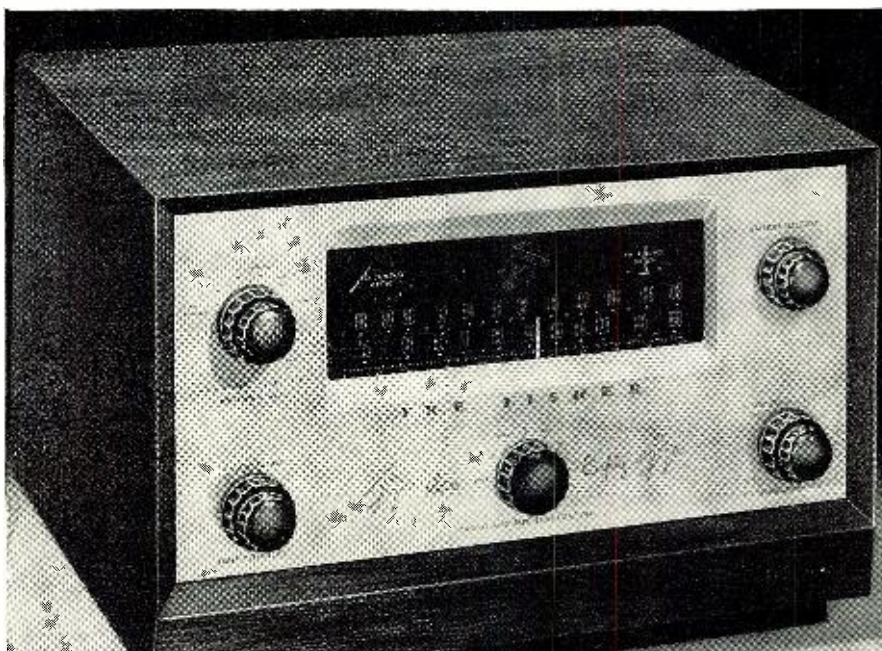

MODEL 80-T • MOST ADVANCED PROFESSIONAL TUNER WITH COMPLETE AUDIO CONTROL

# Hit of the Audio Fairs!

THE SERIES 80

# FISHER FM-AM TUNERS

Here are America's first FM-AM tuners with TWO meters for micro-accurate tuning, just one of the *many* unique features that mark THE FISHER Models 80-T and 80-R as the finest you can buy. They follow deservedly the unmatched reputation of their predecessors, Models 70-RT and 50-R. The 80-T and 80-R are truly designed for the future.

#### Outstanding Features of THE FISHER Series 80

- The 80-T features *extreme sensitivity* (1.5 mv for 20 db of quieting.) ■ *Separate* FM and AM front ends, completely shielded and shock-mounted. ■ *Separate* tuning meters for FM and AM ■ 72-ohm, plus *exclusive*, balanced 300-ohm antenna inputs for increased signal-to-noise ratio. ■ AM selectivity adjustable; AM sensitivity better than 1 microvolt. ■ Inherent hum *non-measurable*. ■ Distortion below 0.04% for 1 volt output. ■ 4 inputs, including separate *tape playback* preamp-equalizer. ■ Six record equalization choices. ■ Two cathode follower outputs. ■ 16 tubes, (80-R: 13 tubes.) ■ 8 controls including Bass, Treble, Volume, Function, Equalization, Tuning, Loudness Balance, AFC. ■ Self powered. ■ Magnificent appearance and workmanship. ■ CHASSIS SIZE: 12¾" wide, 8¾" deep less knobs, 6" high (80-R: 4" high.) ■ NOTE: Model 80-R is identical to the above, but is designed for use with an external audio control such as THE FISHER Series 80-C.

MODEL 80-R • FOR USE WITH EXTERNAL AUDIO CONTROL



MODEL 80-T  
**\$199<sup>50</sup>**

MODEL 80-R  
**\$169<sup>50</sup>**

MAHOGANY OR BLONDE  
CABINET, \$17<sup>95</sup>

Write For FULL Details

**FISHER RADIO CORP.**

21-23 44th DRIVE  
LONG ISLAND CITY 1, N. Y.



## Examine FREE



### Prentice-Hall ELECTRONICS & UHF LIBRARY

Edited by W. L. EVERITT

**5 VOLUMES 1662 ILLUSTRATIONS**  
Pay Easy Installments If You Keep the Set  
Turn to this new, up-to-date Library with complete confidence, for dependable facts on any phase of modern electronic theory and practice. These volumes, by outstanding authorities, give you thorough guidance—clearly written, logically arranged, profusely illustrated.

#### Electronic Fundamentals and Applications

By Prof. John D. Ryder, Dean, College of Engineering, Michigan State College

Complete, logical, easy-to-follow treatment of (a) physical principles underlying electron tubes, (b) characteristics of vacuum tubes, (c) all basic tube circuits. Includes: Electron Ballistics, Cathode-Ray Tubes, Emission of Electrons, Space Charge in Vacuum Tubes, Diode Rectifiers, Triodes, Multi-Element Tubes, Small-Signal Amplifier Circuits, Audio-Frequency Amplifiers, Radio-Frequency Amplifiers, Oscillator Circuits, Modulation Systems, Wave-Shaping Circuits, Gaseous Conduction, Gas Diodes, Gas Control Tubes and Circuits, Photoelectric Cells, Solid-State Electronics.

#### Electromagnetic Waves and Radiating Systems

By Prof. Edward C. Jordan, Head, Dept. of Electrical Engineering, Univ. of Illinois

Covers entire field of electromagnetic engineering. Includes propagation as well as radiation and transmission. Full treatment of UHF transmission lines, wave guides, antennas, slot antennas, radiation and diffraction, ground-wave and sky-wave propagation.

#### Ultra High Frequency Engineering

By Thomas L. Martin, Head, Dept. of Electrical Engineering, Univ. of Arizona

Theory and technique of ALL the new fields of electronic engineering: Radar, Telemetry, Electronic computing, Facsimile, Television, Blind landing systems, Pulse-time modulation, Ionosphere measurements . . . and the others.

#### Networks, Lines and Fields

By Prof. John D. Ryder, Dean, College of Engineering, Michigan State College

Network transformations and theorems. Resonance. Impedance transformation and coupled circuits. Filters. General transmission line. High-frequency line. Equations of the electromagnetic field. Radiation. Transmission and reflection of plane waves at boundaries. Guided waves between parallel plates. Wave guides.

#### Elements of Television Systems

By George E. Anner, Univ. of Illinois

Complete basic theory, plus current practice, covering: Closed TV systems. Commercial Telecasting Systems, Color TV Systems. Gives clear exposition of all phases of picture transmission, including the new technique of dot interlace.

## SEND NO MONEY — EXAMINE FREE

Just mail coupon below to get complete 5-Volume Set on 10 DAYS' FREE TRIAL. If not completely satisfactory, return in ten days and owe nothing. Or keep the set and pay only \$7.50 down and \$8 a month for five months until full price of \$47.50 is paid. Decide for yourself—without risk or obligation—just mail coupon to examine Library ten days free.

Prentice-Hall, Inc., Dept. 5741-A1  
Englewood Cliffs, N. J.

Send me the Prentice-Hall ELECTRONICS & UHF LIBRARY (5 Volumes) for ten days' free examination. If fully satisfied in ten days I will send you \$7.50 plus few cents postage and then \$8 a month for five months until full price of \$47.50 is paid. Or I will return the Library in ten days and owe nothing.

Name .....  
Address .....  
City and State .....

## Those Tough Dogs

(Continued from page 53)

another heater-to-cathode leak was replaced. The sound and picture came on, but the picture was weak and shrunken and the sound noisy. The 12AU7 video amplifier tube, selenium rectifiers, 6S8 audio detector, and 19BG6 horizontal amplifier were changed and the set began to play like new.

To repair this set, six tubes, two selenium rectifiers, one capacitor, and one resistor were changed and it took hours of labor and checking. Our company took a beating on the job.

Fixing "dogs" has its compensations. If you fix a receiver that other companies couldn't, the word will get around. Your reputation will grow which, in turn, brings more customers. These "dogs" are perhaps the best experience a TV service technician can have to make a better technician out of him; they impart a backlog of knowledge that can't be gotten any other way.

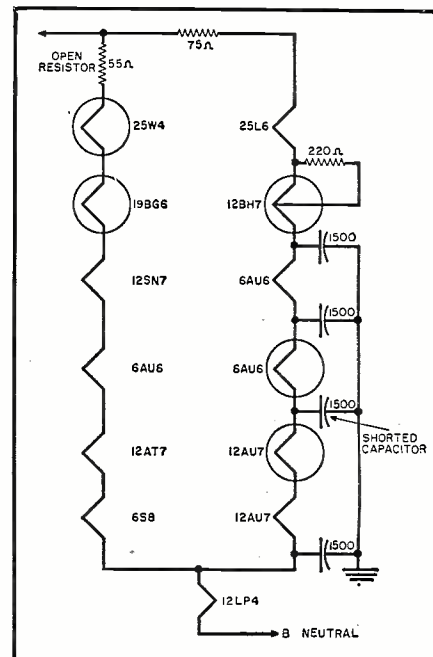

Fig. 4. All the circled components in this heater circuit of a 12" Emerson were bad.

## INEXPENSIVE COAXIAL ANTENNA FOR 10 AND 15

By W. H. B. COWAN, W5BDC

DESCRIBED herewith is a simple, efficient, and inexpensive (about \$2) antenna for ten or fifteen meters. It requires no complicated masts, mounts, or rotators.

Using the dimensions given in the drawing, it will be resonant at 29.0 mc. All the grid dipping, micro-matching and antenna-scoping has been done. The drawing shows a section of RG-11/U coax cable which has been transversely expanded for clarity.

There is no problem of matching the feeder to the antenna, as it is all one unit.

Excellent signals have been reported locally as well as short skip with about 120 watts, with the top of the antenna some 30 feet above ground level.

Maritime mobile contacts have been made over short skip (about 1500 miles) from the edge of a pine forest, using this antenna hung from the limb of a tall pine and fed directly from the output of an AF67 mobile transmitter.

The feeder length can be anything over about six feet or the antenna can be connected directly to the transmitter.

To construct a ten-meter antenna, first remove nine feet of the outer vinyl covering. Then work the shielding braid downward and over the vinyl covering until it is 8 feet, four inches long. Tape the end firmly in place. Then bend the length of wire (inner conductor) back until the length from where it leaves the cable to the end of the eye thus formed is 8 feet, 4 inches. Pass the "eye" through an insulator, solder a connector or the end of the feedline and the job is finished.

Hang the antenna in the nearest tree, to a corner of your house or garage, or run it up a wooden flagpole. The higher the better. On a boat, it may be run up a signal halyard, a topping lift, or a gantline. If it gets in the way, lower it. If you move, roll it up and take it with you.

This type of antenna has no feeder radiation. Using RG-11/U the feedline is non-resonant, the impedance of the line is the same as the half-wave impedance of the half-wave antenna formed by the "folded" braid and the exposed conductor.

It provides low radiation angle and is omnidirectional.

It does not have the gain of, for example, a six-element beam; but neither does it take up as much space, attract as much attention, or remotely approach the beam in cost.

For fifteen meters, make each element ten feet, eleven inches long.

Details on the antenna for 10 meters. See text for dimensions used for 15 meters.

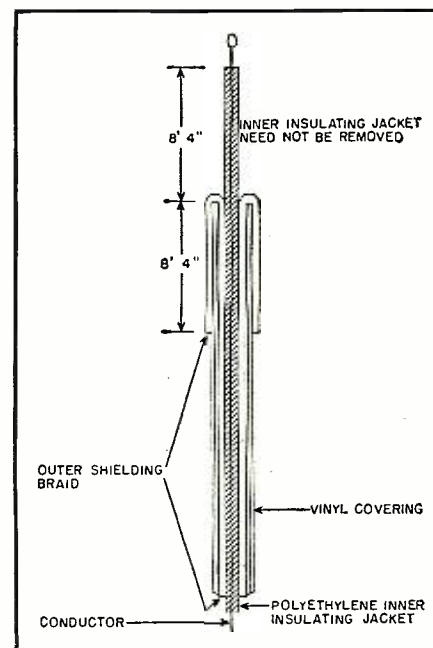



# ALLIED knight-kits

give you **MORE** precision quality...save you **MOST**  
**FINEST ELECTRONIC EQUIPMENT IN KIT FORM—FAMOUS FOR:**



**LOW COST**—huge buying power and **DIRECT SALE** pass biggest savings on to you. You do the easy assembly and your built-up instrument is equivalent in appearance and performance to equipment selling for several times the **KNIGHT-KIT** price.

**ADVANCED DESIGN**—months of research, development and field testing go into each **KNIGHT-KIT** to assure top performance.

**EASY ASSEMBLY**—all chassis and panels are punched for accurate assembly; all parts are fully identified. Instruction manuals are a marvel of simplicity and clarity.

**ALLIED**—the reliable name in Electronics—gives you the greatest value in **KNIGHT-KITS** through **DIRECT SELLING**

**NEWEST  
 PRINTED CIRCUITS**

## knight-kit PRINTED CIRCUIT 5" OSCILLOSCOPE KIT

Model F-144

**\$69<sup>00</sup>**

**\$6.90 down,  
 12 months to  
 pay balance**

New wide-band, full-size 5" Oscilloscope; equals or betters the performance of commercially-wired 'scopes costing several times the price. Two printed circuit boards and exclusive laced wiring harness cuts assembly time to minimum. Ideal for the professional Laboratory, for color TV servicing and high frequency applications. Has 6 times the usual sweep range—from 15 to 600,000 cps. Locks in frequencies as high as 9 mc. Vertical response from 5 cycles to 5 mc.

Response:  $\pm 1$  db at 3.58 mc;  $\pm 3$  db at 5 mc. High vertical sensitivity of 25 rms millivolts/inch. Input capacitance 20 mmf. Outstanding features: cathode-follower vertical and horizontal inputs; 2nd anode provides 1400 volts for high-intensity trace; push-pull vertical and horizontal amplifiers; positive and negative locking; faithful square wave response; frequency-compensated input attenuator; Z-axis input for intensity modulation; one volt peak-to-peak calibrating voltage; internal astigmatism control; blanking circuit to eliminate retrace lines; DC positioning control. Complete with all tubes and parts, ready for easy assembly. Handsome professional case finished in blue, with gray control panel. Shpg. wt., 40 lbs.

Model F-144. Printed Circuit 5" Oscilloscope Kit. Net only. . . . . **\$69.00**  
 Model F-148. Demodulator Probe. Net. . . . . **\$3.45**  
 Model F-147. Low Capacity Probe. 12 mmf. Net. . . . . **\$3.45**

## YOU SAVE MORE BECAUSE YOU BUY DIRECT

Buy with confidence at lowest cost. You get the latest advances in electronic equipment design in **KNIGHT-KITS**. You get premium quality parts for absolute dependability. And you save the **MOST** because you buy **DIRECT**.

Build with confidence. **KNIGHT-KITS** are designed for easiest assembly—all you need is a soldering iron, screwdriver and pliers. Manuals are easy to follow—it's just like having a good instructor at your side.

**ALLIED** stakes its 35-year reputation in the Electronics field on your complete success and fullest satisfaction with **KNIGHT-KITS**.

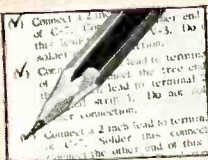

### "STEP-AND-CHEK" ASSEMBLY METHOD

You just follow each step and check it off as you complete it. You always know where you are and what to do next with a **KNIGHT-KIT** Manual.



### "KING-SIZE" DIAGRAMS

Diagrams are duplicated in large wall size to hang conveniently over your work. Helps you see and understand the finest details clearly and easily.



### "SPOTLIGHT" PICTORIALS

Special two-tone treatment makes it easy for you to spot the circuit you're working on, separates it from work you've already completed. "You always know where you are."

**ALL PRICES NET F.O.B. CHICAGO**

**NEWEST  
 PRINTED CIRCUIT**

## knight-kit PRINTED CIRCUIT VTVM KIT

Model F-125

**\$24<sup>95</sup>**



New, extremely stable, highly accurate VTVM. Greatly simplified wiring—entire chassis is a printed circuit board. Features maximum convenience in arrangement of scales and controls. With peak-to-peak scale for FM and TV work. Ranges: AC peak-to-peak volts, 0-4-40-140-1400-4000; AC rms volts and DC volts, 0-1.5-5-15-50-150-500-1500; ohms; 0-1000, 10K, 100K; 1-10-100-1000 megs; db scale, -10 to +5. Uses low-leakage switches and 1% precision resistors. Balanced-bridge, push-pull circuit permits switching to any range without

adjusting zero set.  $4\frac{1}{2}$ " meter, 200 microamp movement. Polarity reversing switch. Input resistance, 11 megs. Complete kit, ready to assemble. Shpg. wt., 6 lbs.

Model F-125. Printed Circuit VTVM Kit. Net only. . . . . **\$24.95**  
 Model F-126. Hi-Voltage Probe; extends DC range to 50,000 Volts. Net. **\$4.50**  
 Model F-127. Hi-Frequency Probe; extends AC range to 250 mc. Net. **\$3.45**

### EASY PAYMENT TERMS

If your total Knight-Kit order is over \$45, take advantage of our liberal Time Payment Plan—only 10% down, 12 full months to pay. Write for application form.

Order from **ALLIED RADIO**  
 100 N. WESTERN AVE., CHICAGO 80, ILLINOIS

SEE FOLLOWING PAGES



# ALLIED **kn gh -k s ...**



Model F-143  
**\$29<sup>75</sup>**

**knight-kit**

## EASY-TO-BUILD TUBE TESTER KIT--OUTSTANDING VALUE

Expertly designed, up-to-date, ideal for the laboratory or service shop. Remarkably low priced, yet it offers high accuracy, top versatility and convenience. Features provision for testing 600-ma tubes; roll-chart data for all popular series-string types. Tests 4, 5, 6 and 7-pin large, regular and miniature types, octals, loctals, 9-pin miniatures and pilot lamps. Tests for open, short, leakage, heater continuity and quality (by amount of cathode emission). 4½" square meter with clear "GOOD-?-REPLACE" scale. With line-voltage indicator and line-adjust control. Choice of 14 filament voltages from .63 to 117 volts. Blank socket for future type tubes. Universal-type selector switches for any combination of pin connections. Single-unit, 10-lever function switch simplifies assembly. Illuminated roll chart lists over 700 tube types. Complete kit, ready for easy assembly. Shpg. wt., 14 lbs.

Model F-143. Counter type Tube Tester Kit. Net only ..... **\$29.75**  
 Model F-142. As above, but with carrying case. Net only ..... **\$34.75**  
 Model F-141. TV Picture Tube Adapter for above. Net only ..... **\$3.75**

## QUALITY ELECTRONIC TEST EQUIPMENT IN LOW COST KIT FORM

### BUY WITH CONFIDENCE

- Advanced Electronic Design
- New Printed Circuits
- Easy-View, Hi-Legibility Panels
- Professional Streamlined Styling
- Matched Instruments
- Premium Quality Components



Model F-137  
**\$31<sup>50</sup>**

**knight-kit**

## AUDIO GENERATOR KIT

Save money—have performance equal to instruments at many times the price! Provides an ideal audio frequency source for checking audio circuits of amplifiers and other hi-fi equipment; also checks speaker response. Frequency range: 20 cps to 1 mc in 5 ranges. Output voltage: 10 volts into 600 ohms impedance, ± 1 db to 1 meg. Generator imp., 600 ohms. Less than .25% distortion from 100 cps through the audible range; less than .5% when driving 600 ohm load at maximum output. Continuously variable step-attenuated output. Circuit as developed by U. S. Bureau of Standards. Complete kit with professional portable case, ready to assemble. Shpg. wt., 17 lbs.

Model F-137. Audio Generator Kit. Net only .... **\$31.50**



## knight-kit 20,000 OHMS/VOLT VOM KIT

Model F-140 TOP VOM VALUE  
**\$26<sup>50</sup>** Outstanding quality and performance at extremely low cost. Features 32 ranges; full vision 4½" meter; accuracy ± 2% of full scale; 50 microampere sensitivity for 20,000 ohms/volt input resistance on DC; front panel "zero adjust." Single switch selects function and range. Range: AC, DC and output volts, 0-2.5, 10-50-250-1000-5000; Resistance, 0-2000-200,000 ohms and 0-20 meg.; DC ma, 0-1-10-100; DC amps, 0-1-10; Decibels, -30 to +63 in 6 ranges. Uses precision 1% multipliers. Complete kit with bakelite case, batteries and test leads. Shpg. wt., 5 lbs.

Model F-140. 20,000 ohms/volt VOM Kit. Net only ..... **\$26.50**



## knight-kit 1,000 OHMS/VOLT VOM KIT

Model F-128 Exceptional accuracy and versatility at amazing low cost. Ideal for service shop, lab and Amateur use. Uses 4½" meter (400 microamp movement) with separate scales for AC voltage and current, DC voltage and current, decibels and resistance. 38 ranges include: AC, DC and Output volts, 0-1-5-10-50-100-500-5000 (1000 ohms/volt sensitivity); Resistance, 0-1000-100,000 ohms and 0-1 meg.; Current, AC or DC, 0-1-10-100 ma and 0-1 amps; Decibels, -20 to +63 in 6 ranges. Uses 1% precision resistors. 3-position function switch and 12-position range switch. Complete kit with bakelite case, battery and test leads. Shpg. wt., 2½ lbs.

Model F-128. 1,000 ohms/volt VOM Kit. Net only ..... **\$14.25**

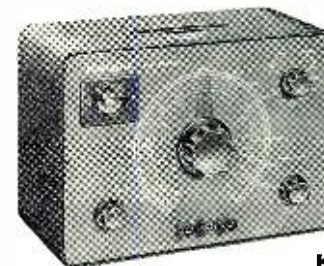

Model F-124  
**\$18<sup>75</sup>**

**knight-kit**

## RESISTOR-CAPACITOR TESTER KIT

This new highly accurate tester meets the critical requirements of lab and service shop. Measures capacitance and resistance; checks for opens and shorts in paper, mica and ceramic capacitors; shows power factor of electrolytics. Large dial shows capacitance and resistance at a glance; balanced-bridge circuit with "magic eye" for correct dial setting. Direct-reading potentiometer and "magic eye" measure power factor from 0-50%. Tests capacitors with rated voltages applied. 5 test voltages: 50, 150, 250, 350, 450. Capacity ranges: 10 mmf to .005 mfd, .001 to .5 mfd, .1 to 50 mfd and 20 to 1000 mfd. Resistance ranges: 100 to 50,000 ohms and 10,000 ohms to 5 megs. Accuracy, ± 10%. Automatic discharge feature prevents after-test shock. Complete kit with professional portable case includes tubes, instructions and all required parts. Shpg. wt., 8 lbs.

Model F-124. Resistor-Capacitor Tester Kit. Net only ..... **\$18.75**

**EASY PAYMENT TERMS:** If your total kit order comes to over \$45, take advantage of our liberal Time Payment Plan—only 10% down, 12 full months to pay. Write for application form.

## BUY DIRECT AND SAVE!

order from **ALLIED RADIO** 100 N. WESTERN AVE., CHICAGO 80, ILL.



**better by far...easiest to build and YOU SAVE MORE\***

**IDEAL FOR SERVICE TECHNICIANS,  
INDUSTRIAL LABS, TRAINING SCHOOLS**

**\*YOU SAVE  
because you  
BUY DIRECT**

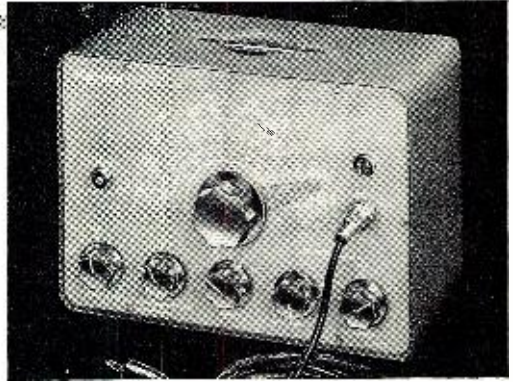

**Crystal-Clear Instruction Manuals**  
**"Step-and-Chek" Building Method**  
**"King-Size" Diagrams**  
**"Spotlight" Pictorials**

**SAVE MONEY! BUY DIRECT**—get top quality—get the most for your test instrument dollar.

Model F-145  
**\$19<sup>75</sup>**

**knight-kit LOW-COST RF SIGNAL GENERATOR KIT**

An extremely popular kit, noted for its wide range and exceptional stability—saves you two-thirds the cost of a comparable wired instrument. Delivers output on fundamentals from 160 kc all the way out to 110 mc; useful harmonic output to 220 mc. Ideal for aligning RF and IF stages and for audio equipment troubleshooting. Also serves as TV marker generator when used with any sweep generator. Features the famous Colpitts circuit for high accuracy with negligible drift. RF output rated over 100,000 microvolts. Output can be modulated at 400 cycles. Has built-in sine-wave audio oscillator with output jack for 400 cycle output. Maximum audio output, 10 volts. Jack for external modulation; step and continuous-type output attenuators. Complete kit with professional portable case, including punched chassis, tubes, pre-wound coils and all required parts. Shpg. wt., 10 lbs.

Model F-145. RF Signal Generator Kit. Net only..... **\$19.75**



Model F-135  
**\$23<sup>75</sup>**

**knight-kit  
VISUAL-AURAL SIGNAL TRACER KIT**

A remarkable value in a kit which permits visual and aural signal tracing of RF, IF, video and audio circuits—costs no more than an audio signal tracer alone. Traces the signal from the antenna to the speaker. Reproduces signal at plate or grid connection of any stage. Identifies and isolates "dead" stages. Features: high usable gain of 50,000; "magic eye" with calibrated attenuators for signal presence indication and stage-by-stage gain measurements; built-in 4" PM speaker; RF probe for checking all stages; special audio probe tip included; provides noise test; built-in watt meter calibrated from 25 to 1000 watts; provision for external scope or VTVM. Complete kit with portable case. Shpg. wt., 13 lbs.

Model F-135. Visual-Aural Signal Tracer Kit. Net only..... **\$23.75**



**knight-kit  
RESISTANCE  
SUBSTITUTION BOX KIT**

Model F-139  
**\$5<sup>95</sup>**

Supplies 36 standard 1 watt resistance values between 15 ohms and 10 megohms with an accuracy of 10%. Resistance values are readily substituted into any circuit to determine proper value of resistor required to do a particular job. Uses simple, single 18-position switch for resistance selection, plus a slide switch which multiplies all values by 1000. In attractive bakelite case, 5 x 3 x 2". Complete with all parts, including 18" leads with insulated alligator clips. Full instructions for easy assembly. Shpg. wt., 2 lbs.

Model F-139. Resistance Substitution Box Kit. Net only..... **\$5.95**

**ALL PRICES NET  
F. O. B. CHICAGO**



Model F-119  
**\$11<sup>65</sup>**

**SAVE UP TO 70%!  
SUPER-VALUE knight-kit  
CAPACITOR CHECKER KIT**

Tests capacitors while they are still wired in the circuit! Saves time and bother in testing the many capacitors in a set; it's an absolutely essential instrument for the service technician. Just press a button and the "magic eye" instantly shows opens and shorts. Checks by-pass, blocking,

coupling and filter condensers from 20 mmf to 2000 mfd, even when the capacitor under test is wired with a resistance as low as 60 ohms. Capacitors between .1 mfd and 2000 mfd may be tested even when in parallel with resistance as low as 2 ohms. Housed in the professionally styled Knight-Kit case, sturdy steel in blue wrinkle finish with gray control panel. Complete kit, ready for easy assembly. Shpg. wt., 5 lbs.

Model F-119. Capacitor Checker Kit. Net only..... **\$11.65**



Model F-138  
**\$5<sup>50</sup>**

**knight-kit CAPACITANCE SUBSTITUTION BOX KIT**

Provides 18 standard capacitor values from .0001 mfd. to .22 mfd., ± 20%. All values are 600 volt, with the exception of .15 and .22 which are 400 volt. A single 18-position switch selects all values quickly and easily—no need to touch the test leads. Saves hours of time and effort required to determine proper condenser value required. In bakelite case with anodized aluminum panel; 5 x 3 x 2". Complete with all parts, including 18" leads with insulated alligator clips. Easy to assemble in just minutes. Shpg. wt., 2 lbs.

Model F-138. Capacitance Substitution Box Kit. Net only..... **\$5.50**

**YOU SAVE MORE BECAUSE YOU BUY DIRECT • ORDER TODAY**



# ALLIED *kn gh -k s ....*

## LOW-COST QUALITY HAM GEAR

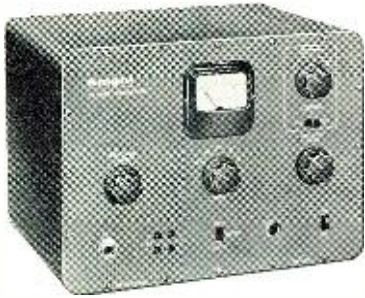

### knight-kit 50 WATT CW TRANSMITTER KIT

Model SX-255

**\$42<sup>50</sup>**

#### Built-in Pi-Type Antenna Coupler

Check the features packed into this new transmitter kit and you'll see why it's one of the greatest Amateur values ever offered. Compact and versatile, it is the perfect low-power rig for the beginning Novice or seasoned veteran. Features: 50 watts input to 807 final; high-efficiency 6AG7 modified-Pierce oscillator takes crystal or VFO without circuit changes; bandswitching coverage of 80, 40, 20, 15, 11-10 meters; pi-section antenna output matches line impedances from 50 to 1200 ohms—permits use with any type of antenna. Crisp, clean, cathode keying of oscillator and final. Power take-off plug supplies filament and B-plus voltages for other equipment. Copper-finished chassis and cabinet interior, filtering, shielding, bypassing, and coaxial SO-239 antenna connector provide excellent TVI suppression. Meter reads either plate or grid current of final. Jacks for VFO, crystal, and key. Supplied with all parts, tubes and step-by-step instructions. Less crystal and key. Size, 8<sup>3</sup>/<sub>16</sub> x 11<sup>1</sup>/<sub>16</sub> x 8<sup>3</sup>/<sub>4</sub>". For 110-120 v., 50-60 cycle AC. Shpg. wt., 18 lbs.

SX-255. 50-Watt Transmitter Kit. Net. .... **\$42.50**



### knight-kit SELF-POWERED VFO KIT

Model S-725

**\$27<sup>50</sup>**

Complete with built-in power supply! Careful design and voltage regulation assure high stability. Excellent oscillator keying characteristic for fast break-in without clicks or chirps. Full TVI suppression. Has plenty of bandspread; separate calibrated scales for 80, 40, 20, 15, 11 and 10 meters; vernier drive mechanism. 2-chassis construction keeps heat from frequency determining circuits. Output cable plugs into crystal socket of transmitter. Output on 80 and 40 meters. With Spot-Off-Transmit switch for "no swish" tuning. Extra switch contacts for operating relays and other equipment. Complete kit for easy assembly. Shpg. wt., 8 lbs.

Model S-725. Self-Powered VFO Kit. Net. .... **\$27.50**



### knight-kit CODE PRACTICE OSCILLATOR KIT

Model S-239

**\$4<sup>95</sup>**

Transistorized—  
Powered by Flash-  
light Battery

An ideal new code practice oscillator. Uses transistor circuit. Extremely low current consumption—powered by single penlight battery. Provides crisp, clear tone (400 to 600 cps). Has input jack for earphone; screw-type terminal strip for key. In compact bakelite case (2<sup>3</sup>/<sub>4</sub> x 3<sup>3</sup>/<sub>4</sub> x 1<sup>1</sup>/<sub>2</sub>"") with anodized aluminum panel. Complete with all parts, battery and easy-to-follow instructions. Shpg. wt., 1 lb.

Model S-239. Code Practice Oscillator Kit .... **\$4.95**

## FAMOUS *kn gh -k s ....* FOR HOBBYISTS... EASY-TO-BUILD... FEATURING EXCEPTIONAL PERFORMANCE AT LOW COST

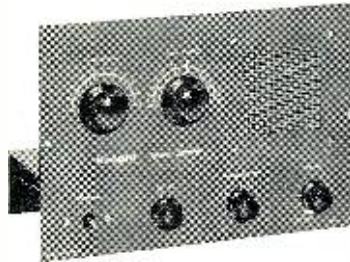

Model S-243

**\$13<sup>95</sup>**

### knight-kit "SPACE SPANNER" BAND SWITCHING RECEIVER SET

#### DUAL BAND FOR THRILLING SHORT WAVE & BROADCAST

All-new 2-band receiver in easy-to-build kit form at a very low price. Pulls in thrilling short-wave (6 to 17 mc) and standard broadcast, plus amateur, aircraft, police and marine radio. Features special regenerative circuit; highly sensitive on broadcast band. Band-switch selects broadcast or short wave. Has 4" PM speaker and beam-power output tube for plenty of volume; headphone connectors for weak signal listening; slide switch cuts out speaker. Employs 12AT7 regenerative detector and audio amplifier; 50C5 power output; 35W4 rectifier. Six controls; Bandsread; Main Tuning; Antenna Trimmer; Bandswitch; Regeneration; Audio Gain. Panel finished in attractive gray with black knobs. Includes all parts, punched chassis and tubes. 7 x 10<sup>1</sup>/<sub>2</sub> x 6"; for 110-120 v. 50-60 cycles AC or DC. Shpg. wt., 4<sup>1</sup>/<sub>2</sub> lbs.

Model S-243. "Space Spanner" Receiver Kit. Net. .... **\$13.95**

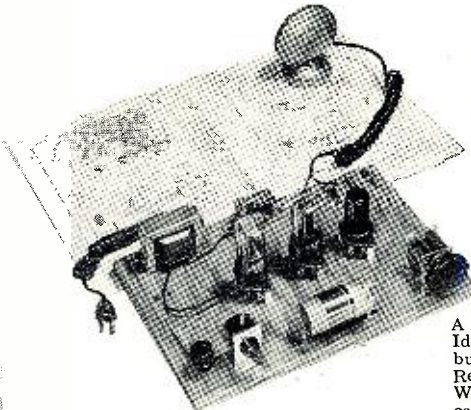

Model S-265

**\$12<sup>45</sup>**

### knight-kit 10-IN-1 LAB KIT

#### BUILD ANY OF 10 FASCINATING ELECTRONIC PROJECTS

A wonderfully instructive electronics kit. Ideal for experimenters, beginners—fun to build. Construct a sensitive Broadcast Receiver; Amplifier (for phono or mike); Wireless Phono Oscillator; Home "Broadcast Station"; Code Practice Oscillator;

Capacity-Operated Relay, or any one of four other fascinating projects. Low voltages; safe to build and operate. Only tools needed are soldering iron, screwdriver and pliers. Perfect for self-instruction in circuit fundamentals, and packed with practical applications. Kit includes mounting board, tubes, all parts, hardware, microphone, and 12-page builders' manual. For 110-120 v., 50-60 cycle AC. Shpg. wt., 10 lbs.

Model S-265. "10-in-1" Kit. Net. .... **\$12.45**

Model P-003. Phototube for Photo Relay Project. Net. .... **\$2.00**

Model H-024. 4-Prong Socket for Phototube. Net. .... **8¢**

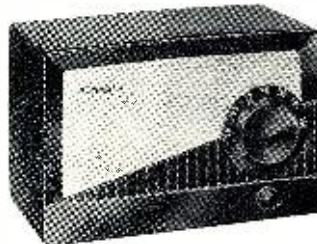

Model S-735

**\$14<sup>85</sup>**

### knight-kit "RANGER II" SUPERHET RADIO KIT

Thousands have built and enjoyed the "Ranger" Broadcast Band Receiver. Carefully engineered for easy construction and powerful, sensitive performance. Latest Superhet circuit; tunes 540 to 1680 kc; covers entire broadcast band and exciting police calls. Features automatic volume control, built-in pre-formed loop antenna, ball-bearing tuning condenser. Develops excellent tone quality from Alnico V PM dynamic speaker. Supplied with following tubes: 12SK7GT IF amp.; 12SQ7GT det. -AVC- audio; 50L6GT audio output; 35Z5GT rect. Complete with handsome brown plastic cabinet, tubes, speaker, all parts, and instruction manual. For 110-120 v., 50-60 cycle AC or DC. Shpg. wt., 8 lbs.

Model S-735. "Ranger II" Superhet Radio Kit. Net. .... **\$14.85**

Receiver Kits Supplied Less Wire and Solder

Order from **ALLIED RADIO** 100 N. WESTERN AVE., CHICAGO 80, ILL.



# Top Quality Electronic Equipment in Kit Form

SAVE MORE  
BUY DIRECT

FASCINATING, INSTRUCTIVE  
USED BY MANY LEADING TRAINING SCHOOLS

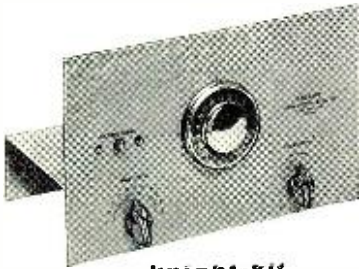

knight-kit

## "OCEAN HOPPER" RECEIVER KIT

Model S-740 BROADCAST, LONG WAVE & SHORT WAVE RECEPTION

**\$10<sup>75</sup>**

The famous "Ocean Hopper" receiver kit—sensationally low-priced—tops for enjoyable broadcast, long wave and short wave reception. Highly sensitive regenerative-type circuit. Excellent head-phone reception; can be used with 3-4 ohm PM speaker on strong broadcast band stations. Supplied with plug-in coil for standard broadcast; covers long wave and popular short wave bands with coils below. Pulls in thrilling foreign broadcasts, police, amateurs and aircraft. Controls: Main Tuning, Bandsread, Antenna Tuning, Off-On-Regeneration. Handsome gray panel, logging type lucite main tuning knob. With all parts, tubes, instructions (less extra coils and headset). AC or DC operation. Shpg. wt., 5 lbs. Model S-740. "Ocean Hopper" Receiver Kit. Net. . . . . **\$10.75**

### EXTRA PLUG-IN COILS

- S-741. Long Wave, 155-470 kc. Net. . . . . 79¢
- S-742. Short Wave, 1.65-470 kc. } Net
- S-743. Short Wave, 2.9-7.3 mc. } each. . . . . 65¢
- S-745. Short Wave, 7-17.5 mc. }
- S-744. Short Wave, 15.5-35 mc. }



## knight-kit TRANSISTOR RADIO KIT

PRINTED WIRING—  
WORKS FROM  
FLASHLIGHT CELL

Model S-765  
**\$3<sup>95</sup>**

Experiment with the marvel of transistors in this new transistorized, printed-circuit radio. No tubes—no crystal! Small enough to fit in the palm of the hand—yet it provides powerful reception over the complete AM broadcast band. Transistor provides extra audio power for loud, clear reception. Operates from single flashlight cell. Designed for use with headphones. Printed circuit eliminates wiring—just assemble and solder a few connections—that's all there is to it! Supplied complete with all parts, hardware, battery, and easy-to-follow instructions. Less antenna and headphone (use 3000 ohms or higher). Shpg. wt., 8 oz. S-765. Transistor Radio Kit. Net. . . . . **\$3.95**

### RECEIVER KIT ACCESSORIES

- 2000 Ohms Headset. Dual headset for use with "Space Spanner", "Ocean Hopper" and "10-in-1 Lab" Kits. J-110. Net. . . . . \$1.79
- 5000 Ohms Headset. Dual headset for Transistor Radio Kit. J-126. Net. . . . . \$3.38
- Antenna Kit. For use with all Knight-Kit receiver kits. C-100. Net. . . . . \$1.05

ALL PRICES NET F. O. B. CHICAGO

## BUILD-YOUR-OWN HIGH FIDELITY knight-kits

### knight-kit BASIC 25 WATT ULTRALINEAR HI-FI AMPLIFIER KIT

Model S-755

**\$41<sup>50</sup>**

TOP CUSTOM QUALITY—  
ETCHED CIRCUIT WIRING



This new super-quality hi-fi basic amplifier is designed to satisfy the most critical listener. Intended for use with tuners incorporating built-in preamp or with separate preamp. Uses latest Williamson type ultralinear circuit with potted, matched transformers. Delivers maximum output of 45 watts. Frequency response:  $\pm 0.5$  db, 10 cps to 120 kc, measured at 20 watts. Harmonic distortion is only .15% right up to 30 watts. IM distortion is only .27% at 10 watts and only 1% at 20 watts, using 60 cps to 7 kc, 1:4 ratio. Hum level is — 85 db below full rated output. Output impedance, 4, 8, 16 ohms. Input voltage for 25 watt output is 1.8 volts. Uses two 12AU7's, two 5881's, and a 5V4. Etched circuit is utilized in voltage amplifier and phase inverter stages. Has output tube balancing control, variable damping control, and on-off switch. Handsome chrome-plated chassis, 14" x 9" x 2". Overall height, 7". A deluxe true hi-fi amplifier in every detail—satisfying to build—equal in performance to amplifiers selling at over twice the price. Complete with all parts, tubes and construction manual. Shpg. wt., 27 lbs.

Model S-755. Basic 25 watt Hi-Fi Ultralinear Amplifier Kit. Net. . . . . **\$41.50**

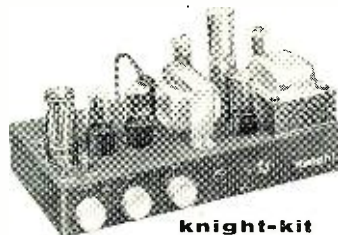

knight-kit

### 10 WATT HI-FI AMPLIFIER KIT

Model S-234

**\$20<sup>95</sup>**

Famous for wide response and smooth reproduction at low cost. Only 0.5 volt drives amplifier to full output. Frequency response:  $\pm 1$  db, 30-20,000 cps at 10 watts. Harmonic distortion less than 0.5% at 10 watts. Intermod. distortion less than 1.5% at full output. Controls: on-off-volume, bass, treble. Input for crystal phono or tuner. Chassis punched to accommodate preamp kit. Matches 8 ohm speakers. Shpg. wt., 14 lbs.

Model S-234. Amplifier Kit. Net. . . . . **\$20.95**

Model S-235. Preamp Kit for above. Net. . . . . **\$2.75**

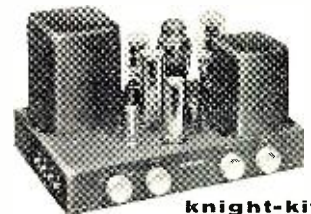

knight-kit

### 20 WATT HI-FI AMPLIFIER KIT

Model S-750

**\$34<sup>75</sup>**

True hi-fi for less! Frequency response,  $\pm 1$  db, 20 to 20,000 cps at 20 watts. Distortion, 1% at 20 watts. Hum and noise level: tuner input, 90 db below 20 watts; phono, 72 db below 20 watts. Sensitivity: tuner input, 0.6 volt for 20 watts output; magnetic phono, .007 volts. 4 inputs: magnetic phono, microphone, crystal phono or recorder, and tuner. Controls: Bass, Treble, Volume, Selector. With compensation positions for 78 and LP records, controlled from front panel. 23 lbs. Model S-750. 20-Watt Hi-Fi Amplifier Kit. Net. . . . . **\$34.75**

Amplifier Kits Supplied Less Wire and Solder

# ALLIED RADIO

Everything in Electronics from One Reliable Source

Allied Radio Corp., Dept. 1-A-6, 100 N. Western Ave., Chicago 80, Ill.

Ship me the following KNIGHT-KITS:

Quantity	Description	Model No.	Price

\$ . . . . . enclosed. For parcel post include postage (express is shipped collect).

Name \_\_\_\_\_

Address \_\_\_\_\_

City \_\_\_\_\_ Zone \_\_\_\_\_ State \_\_\_\_\_

ORDER TODAY →



## Sylvania Test Points

(Continued from page 51)

How good  
will your  
new tape  
recorder be?

One of the answers lies in the quality of the magnetic recording head—a basic and important part of all recorders. The better the head, the better the performance you can expect. A Shure magnetic recording head insures a unit constructed to close tolerances . . . precision specifications . . . optimum performance of your recorder.

An outstanding example is the "Micro-Gap," a new, high quality magnetic recording head specifically designed for use in professional studio and fine quality home tape recorders. It provides excellent response over an extremely wide frequency range . . . long operating life at maximum efficiency. For home recordings of professional stature, or for precision data recording equipment, the "Micro-Gap" cannot be excelled.

The "Micro-Gap" is the latest of the Shure family of fine-quality magnetic recording heads. When a tape recorder manufacturer announces a model equipped with any of them, you can be assured of the high quality of the tape recorder . . . for the choice of a Shure head is proof that the manufacturer is giving you the very best.

The Mark of Quality



**Pioneers in Magnetic Recording  
Since 1939**

**SHURE BROTHERS, Inc.**  
225 West Huron Street, Chicago 10, Illinois

of the horizontal frequency coil ( $L_{100}$ , Fig. 4) and set the horizontal hold control to mid-range.

4. Adjust the horizontal range control until the picture moves back and forth across the screen with the blanking bar vertical.

5. Remove the jumper from  $L_{100}$ , then adjust the coil until the picture again behaves as in step 4.

6. Remove the short from pin 8 of  $V_{13}$ .

With an oscilloscope sweeping at 30 cycles, test point 8 (pin 3 of the 6W6) should indicate 400 volts peak-to-peak. The observed waveform is voltage from the vertical output stage and should be checked for linearity. Nonlinearity may be due, among other causes, to low emission of the vertical oscillator tube, a leaky decoupling capacitor in the plate circuit of the oscillator, a defective vertical output transformer, or a defective cathode resistor and its bypass capacitor.

Pickup from leads not properly dressed may cause poor vertical sync. For instance, the hot lead from the

horizontal deflection coil may have shifted too close to the vertical oscillator, or hum may be induced into its grid from the heater wiring.

Sometimes, vertical foldover occurs when the line voltage falls below 100. However, if the a.c. potential hasn't dropped, measure the "B+" at test point 9. A reading of less than 250 volts at normal line voltage denotes trouble in the power supply. Probable causes are a weak selenium rectifier or a leaky charging capacitor in the doubler circuit. An open low-capacity output filter will have slight effect on the "B+" potential, although this condition would put hum into the picture. An oscilloscope connected to this test point should show a ripple of no more than 1.3 volts peak-to-peak.

If a complete failure of "B+" voltage occurs, look for an open fuse or surge resistor. Rarely, of course, does a filter choke open up in any chassis—although the possibility of such an occurrence should not be overlooked.

The test points discussed in this article are found in the 1956 Sylvania horizontal chassis only. Circuitry in the vertical model is quite dissimilar, although the general approach to troubleshooting would be substantially the same.

Fig. 4. Top of chassis diagram of the Sylvania model 533 showing location of tubes.

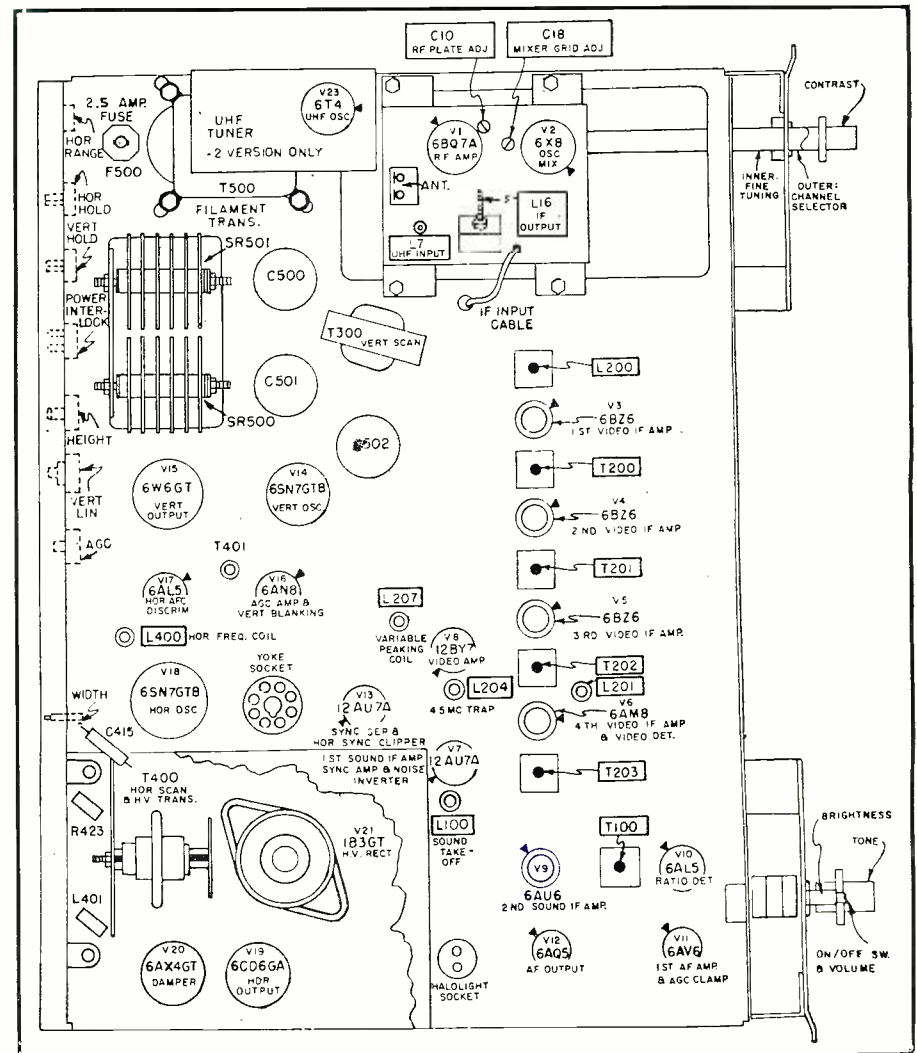



Let me send you the entire story—FREE

Just fill out the coupon and mail it. I will send you, free of charge, a copy of "How to Pass FCC License Exams," plus a sample FCC-type Lesson, and the valuable booklet, "Money-Making FCC License Information."



CARL E. SMITH, E. E.  
President

I can train you to pass your FCC License Exams in a minimum of time if you've had any practical experience—amateur, military, radio servicing, etc. We can put you on the road to success.

# How to Pass FCC

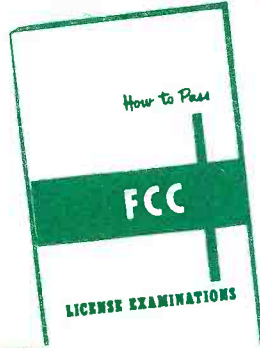

**FREE**

Tells where to apply and take FCC examinations, location of examining office, scope of knowledge required, approved way to prepare for FCC examinations, positive method of checking your knowledge before taking the examination.



GET YOUR FCC TICKET IN A MINIMUM OF TIME

## Get this Valuable Booklet FREE

**TELLS HOW WE GUARANTEE YOUR FCC LICENSE**

HERE IS YOUR GUARANTEE

If you fail to pass your Commercial License exam after completing our course, we guarantee to continue your training without additional cost of any kind, until you successfully obtain your Commercial license.

TO TRAIN AND COACH YOU AT HOME IN SPARE TIME UNTIL YOU GET YOUR FCC LICENSE.

If you have had any practical experience—amateur, military, radio repair, experimenting, etc.

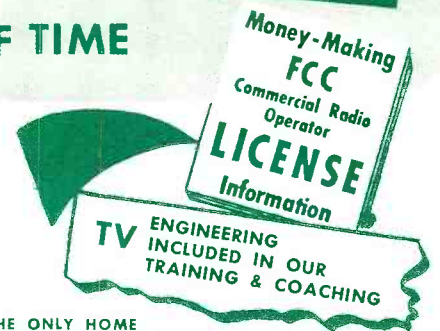

THE ONLY HOME STUDY COURSE WHICH SUPPLIES FCC TYPE EXAMINATIONS WITH ALL LESSONS AND FINAL TESTS.

Your FCC ticket is recognized employers in all phases of Electron as proof of your technical ability

TV ENGINEERING INCLUDED IN OUR TRAINING & COACHING

**TELLS HOW**

**Our Effective JOB FINDING Service Helps CIRE Trainees Get Better Jobs —**

Here are a few recent examples of Job-Finding results.

**ELECTRONICS TECHNICIAN:**

"I am now employed by the Collins Radio Company as a Lab Technician. (This job was listed in your bulletin). I have used the information gathered from your course in so many ways and I know that my training with CIRE helped me a great deal to obtain this job."

Charles D. Sindelar, Cedar Rapids, Iowa

**AIRLINES**

"I replied to the Job Opportunities you sent me and I am now a radio operator with American Airlines. You have my hearty recommendation for your training and your Job-Finding Service."

James A. Wright, Beltsville, Md.

**INDUSTRIAL ELECTRONICS**

"Upon my discharge from the Navy I used your Job-Finding Service and as a result I was employed by North American Aviation in electronic assembly (final checkout)."

Glen A. Furlong, Fresno, Calif.

**TELLS HOW Employers make JOB OFFERS Like These To Our Graduates Every Month**

**Broadcast Station in Illinois:**

"We are in need of an engineer with a first class phone license, preferably a student of CIRE; 40 hour week plus 8 hours overtime."

**West Coast Manufacturer:**

"We are currently in need of men with electronics training or experience in radar maintenance, and we would appreciate it if you will refer interested persons to us."

**HERE'S PROOF FCC LICENSES ARE OFTEN SECURED IN A FEW HOURS OF STUDY WITH OUR COACHING AT HOME IN SPARE TIME.**

	License	Time
A/1C Ronald H. Person, St. Louis 20, Mo.	1st	25 weeks
Carl Verboomen, Wrightstown, Wis.	1st	18 weeks
Marvin F. Kimball, Lafayette, Ind.	2nd	21 weeks
L. M. Bonino, Harlington AFB, Tex	2nd	16 weeks
John E. Hutchison, Bluefield, W. Va.	1st	27 weeks

An Approved Member



**Mail This Card No POSTAGE REQUIRED**

**Get All 3 FREE**



**CLEVELAND INSTITUTE OF RADIO ELECTRONICS**  
4900 Euclid Bldg., Cleveland 3, Ohio

RN-85A

I want to know how I can get my FCC ticket in a minimum of time. Send me your FREE booklet, "How to Pass FCC License Examination" (does not cover exams for Amateur License), as well as a Sample FCC-type lesson and the amazing new booklet "Money-Making FCC License Information." Be sure to tell me about your Television Engineering Course.

PLEASE PRINT CAREFULLY

NAME \_\_\_\_\_ AGE \_\_\_\_\_

ADDRESS \_\_\_\_\_

CITY \_\_\_\_\_ ZONE \_\_\_\_\_ STATE \_\_\_\_\_

Special tuition rates to members of the U. S. Armed Forces. Electronic Training Available To Canadian Residents.

**CLEVELAND INSTITUTE OF RADIO ELECTRONICS**  
CARL E. SMITH, Consulting Engineer, President  
4900 Euclid Bldg., Cleveland 3, Ohio

See our ad on next page



Six months from today  
**Which Will  
 You Hold?**



this-

or this

Add Technical Training  
 To Your Practical Experience-

**GET YOUR FCC LICENSE  
 IN A HURRY!**

Then use our Amazingly Effective  
**JOB-FINDING SERVICE**



Get This  
**Valuable Booklet  
 FREE!**

**TV** ENGINEERING INCLUDED IN OUR  
 TRAINING & COACHING

**IMPORTANT**  
 SEE OTHER SIDE FOR MORE INFORMATION

**TELLS HOW—**

**WE GUARANTEE**

TO TRAIN AND COACH YOU  
 AT HOME IN  
 SPARE TIME UNTIL YOU GET

**YOUR FCC LICENSE**

If you have had any practical  
 experience—amateur, Army, Navy,  
 radio repair, or experimenting.

**Here Is Your  
 GUARANTEE**

If you fail to pass your  
 Commercial License  
 exam after completing  
 our course, we guaran-  
 tee to continue your  
 training without addi-  
 tional cost of any kind  
 until you successfully  
 obtain your Commercial  
 License.

If You're in the Armed Forces **PLAN NOW** for

**PRESENT and FUTURE SECURITY**

- 1 Use your spare time, **NOW**, while you are in the armed forces, to prepare for the FCC license examinations, and get your FCC Commercial License.
- 2 Shortly before discharge, use our **EFFECTIVE JOB-FINDING SERVICE** to get your choice of good-pay jobs.  
 Special tuition rates to members of the U. S. Armed Forces.

**NORTH AMERICAN  
 EMPLOYS  
 EX-ARMY MAN**

"I am employed by North American Aviation as an electronic technician. Their name was received from you while I was in the service overseas. The lessons I completed played a big part in helping me pass their screening examinations.  
 Vernon Skovgaard  
 Los Angeles 6, Calif.

**FORMER NAVY MAN GETS JOB AT COLLINS RADIO**

"Since my discharge from the Navy, I have been working for Collins Radio Company at Cedar Rapids, Iowa, one of the job opportunities you listed. I am giving a lot of credit to your course for helping me in passing the qualifications exam at Collins."  
 Howard Johnson, Marion, Iowa

Postage  
 Will be Paid  
 by  
 Addressee

**BUSINESS REPLY CARD**  
 FIRST CLASS PERMIT No. 8685, Sec. 34.9, P.L.&R., Cleveland, Ohio

Cleveland Institute of Radio Electronics  
 4900 EUCLID AVENUE  
 CLEVELAND 3, OHIO

**TEAR OUT AND MAIL THIS CARD NOW!**

No Postage Stamp  
 Necessary  
 If Mailed in the  
 United States

DAEL PN-RSA





**Frequency Meter**  
(Continued from page 69)

quency meter, and a number of check points obtained for different points on the frequency meter tuning dial.

These points may then be plotted on a standard calibration curve. A different curve will be required for each coil used.

To use the frequency meter, turn the "power" switch "on." Since no tubes are used, no warm-up time is required. Turn the "meter sensitivity" control all the way "up" (for maximum sensitivity).

With the proper coil plugged into the coil socket (to cover the desired band of frequencies), hold the instrument near the source of r.f. energy to be checked and *gradually* adjust the "tuning" control. As the frequency of the signal source is approached, an up-scale meter reading should be obtained. Should the meter pointer tend to go off-scale, either reduce the coupling or turn the "meter sensitivity" control back.

Continue to adjust the "tuning" control until a peak meter reading is obtained. Note the dial setting at this point and check this value against the previously prepared calibration curve to obtain the frequency of the unknown signal source.

The relative strength of the signal source may be determined by the amount of coupling required to obtain a good meter reading, or by how far back the "meter sensitivity" control must be adjusted to avoid an off-scale meter reading.

If strong harmonic signals are present, these may sometimes be detected by plugging in the proper coil and using the frequency meter at maximum sensitivity.

**Applications**

In the ham shack, the frequency meter is quite useful for preliminary checks of a new "rig" and for determining that the "rig" is within the band. The ease of operation of the unit makes it practicable to check station frequency at any time.

The frequency meter is quite valuable in schools, particularly when setting up and working with experimental r.f. circuits. Quite a number of experiments have been based on the use of the r.f. frequency meter.

In the laboratory, the frequency meter is especially handy for checking the operation of experimental transmitter and oscillator set-ups. Because of the good sensitivity of the unit described, it may also be used to check for changes in r.f. output as experimental changes are made in a particular piece of equipment. When used in this application, the coupling between the frequency meter and the r.f. source should be kept fixed, and changes in signal level noted as differences in the peak reading of the meter.

-50-

**Short description of a Small Efficient TV System...**

**1 antenna .. IN**  
**8 set lines .. OUT**  
**10 db signal .. GAIN**

all with  
the



**DISTRIBUTION  
AMPLIFIER**

**model DA8-B**

approved.  
for  
Color-TV

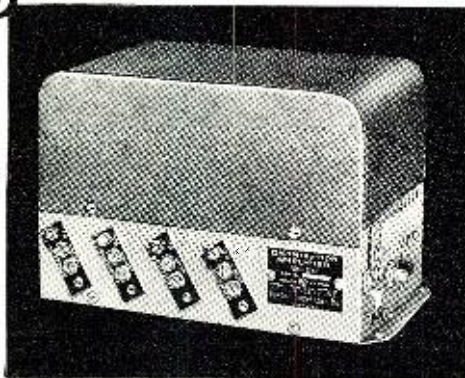

**\$89<sup>50</sup> List**

Ideal for garden apartments, motels, TV showrooms, deluxe home installations and other small TV systems. The DA8-B is a broadband, all-channel unit that requires no tuning, impedance matching devices, preamps or other special fittings.

**Features and Specifications:**

- Low noise all-triode circuit
- More than 10db gain on all VHF Channels
- Inter-set isolation in excess of 22db
- Provision for 75-ohm cable or 300-ohm twin lead
- Prevents overload through 10:1 gain control range
- Built-in power supply
- Designed for continuous duty operation

**NOTE:** For larger systems, Blonder-Tongue will furnish Free planning service on request.

Sold by Radio-TV Parts Distributors and Jobbers.

Write for Installation Details and FREE Booklet—"TV for 2, or 3, or More"

Dept. KA-4

**BLONDER-TONGUE  
LABORATORIES, INC.**  
Westfield, New Jersey



Manufacturers of TV Cameras, TV Amplifiers, Boosters, Converters, Accessories and Originators of the Masterline and 'Add-A-Unit' Master TV Systems.



MERIT, first in exact and universal replacement transformers, yokes, coils—the only manufacturer of transformers, yokes and coils who has complete production facilities for all parts sold under their brand name.

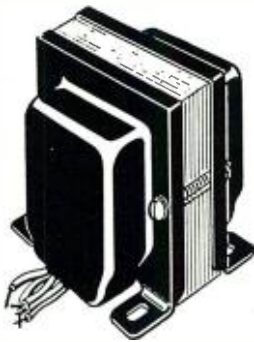

You find MERIT's leading quality and MERIT's original engineering developments throughout the entire Merit catalogued items—the only single source for all your transformer and coil requirements.

# Merit

MERIT COIL & TRANSFORMER COMPANY  
4427 NORTH CLARK STREET  
CHICAGO 40, ILLINOIS



# New G-E Color Picture Tube

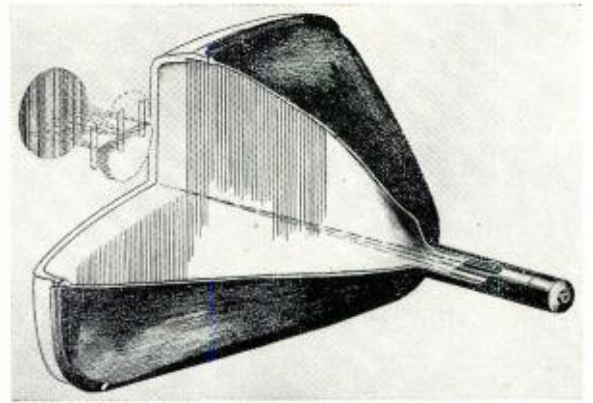

Fig. 1. Shown here is a drawing of the G-E post acceleration P.O.F. color TV tube, still in the development stage.

*Using a grille instead of a shadow mask, and vertical phosphor stripes instead of dots, yields high brightness.*

A COLOR TV picture tube that gives many times more brightness than the tubes in color sets now on the market was recently demonstrated by the General Electric Tube Department. Developmental models of this tube were demonstrated in various degrees of room lighting and produced a bright picture in light comparable to a brightly lighted store.

The new tube, which may not be ready for the production lines until 1957, has a 22-inch rectangular face and uses three guns. However, it is of the post acceleration type, meaning that the electron beams directed at the phosphor screen inside the face of the tube are accelerated after passing through a grille located in close proximity to the phosphor screen. The screen itself consists of vertical color phosphor stripes rather than color phosphor dots.

Fig. 1 is a drawing of the G-E tube, which is known as the P.O.F. tube (phosphor on the envelope face). Considering first the neck end, three electrostatic guns are shown lying in a plane instead of in a triangular array as in the shadow-mask tube. This type of gun structure allows each gun to be

more or less independent of the other two insofar as convergence adjustments are concerned.

On the other end of the tube is the grille (or color selective electrode), which consists of a parallel array of wires fastened to the envelope itself. In front of this is the tube envelope surface on which the red, green, and blue vertical phosphor stripes are printed. In normal operation, the final gun electrode and cone potential are held at about 6½ kilovolts, and the grille is held at a potential of about 200 volts less. The phosphor screen is run at approximately 25 kilovolts.

Fig. 2 shows in simplified terms the operation of the front end of the tube. The electron beams are shown entering the grille with a relatively large angular separation. Actually the angular separation is less than 1 degree. As the electron beam from one of the guns enters the grille region two effects occur; first, the central ray of this beam no longer travels in a straight line, but instead assumes a parabolic path exactly as occurs when one throws a ball which is then acted upon by the earth's gravitational field. In this case the strong electrostatic field between the screen and the grille accelerates the electrons to the high screen potential.

A second action which occurs as the beam enters the grille region is focusing. With properly applied potentials, each pair of grille wires forms an electron optical cylindrical lens which reduces the size of the beam in the horizontal dimension from its initial diameter of about 35 mils to only 5 mils. This makes the beam width small in comparison with the phosphor stripe width, and allows a guard band to form on either side of the beam landing area. Thus, the beam can move about on a particular stripe without striking an adjacent stripe allowing for good color purity.

One strict requirement of this tube is that the ratio of screen-to-grille voltage must be regulated since the electron trajectories between grille and

Fig. 2. Detail drawing showing how the electron beams enter the grille of the G-E tube and are deflected to the screen.

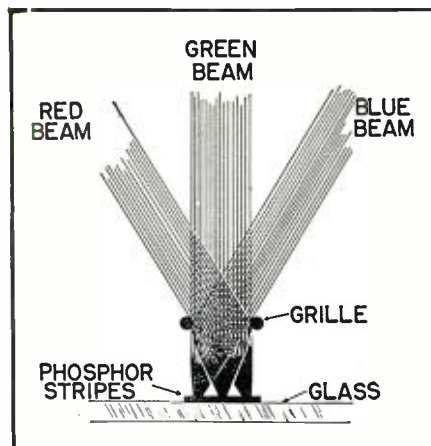



screen and also the properties of the cylindrical lenses are dependent on this ratio.

As claimed by engineers at G-E, the advantages of this tube over the shadow-mask type are that the P.O.F. tube yields higher brightness and uses less deflection power, simplified convergence circuitry, and simplified components on the neck of the tube. The higher brightness results from the fact that, because of the grille-type structure of the color selective electrode, 90 per-cent or more of the electrons ejected from the guns strike the phosphor screen in contrast to about 14 per-cent for the shadow-mask type tube. Less power is used because the beam is operated at a voltage of 6½ kilovolts versus the 27 kilovolts used in the shadow-mask type tube.

Because of the increased brightness of the P.O.F. tube, color selective safety glass can be used resulting in more saturated colors and better contrast in an illuminated room. -30-

### VOICE-POWERED RADIO

THE Army Signal Corps Engineering Laboratories at Fort Monmouth, N. J. has developed a sound-powered radio transmitter that is small enough to fit inside a telephone mouthpiece. As long as the sender speaks, the radio works, and his voice is broadcast.

A unique technique using a single transistor and matched circuit makes it possible for the new transmitter to harness the tiny voice power. In this device, the voice operates the transmitter and runs it. After the speech strikes the microphone, part of its power is filtered to operate the radio, while the rest puts intelligence into the signal put out.

Although still in the experimental stage, this particular transmitter has broadcast more than 600 feet. With higher radio frequencies and a matched antenna, the Signal Corps expects to be able to increase this distance up to a mile.

Further development is also expected to lead to a companion radio receiver weighing only three ounces and powered by the same voice energy. This energy would be built up and stored in the set when sending, and later used for receiving. -30-

Signal Corps' tiny voice-power radio set.



**HARVEY**



**AUTHORIZED DISTRIBUTOR**

*stocks the complete line of*  
**RCA GEIGER COUNTERS**

*for amateur and professional prospectors  
 ... or anyone interested in radioactivity*

"Geiger counter" is by now part of everyone's vocabulary... but then there are Geiger counters and Geiger counters, as Harvey's experts can easily tell you. RCA has exactly the right Geiger counter for every range of use—amateur or professional prospecting, laboratories, schools, industry. They are rugged, dependable, all-weather performers, built to RCA's most exacting standards in components and workmanship.

**2 OUTSTANDINGLY POPULAR MODELS**

**RCA Geiger Counter WF-10A**

**FOR THE AMATEUR PROSPECTOR**

Aluminum Case 8x3½x7½ in. 5 lbs. incl. batteries.

**\$119.50**

Also available with extra-sensitive bismuth-type Geiger-counter tube as Model WF-11A ..... **\$154.50**

**RCA Geiger Counter WF-12A**

**SENSITIVE ENOUGH FOR THE PROFESSIONAL**

Has Geiger-counter tube in external probe for exploring fissures and test bores.

Stainless Steel Case 7¼ x 3½ x 7½ in. 5½ lbs. incl. batteries. **\$149.50**

Also available with extra-sensitive bismuth-type Geiger-counter tube in external probe, as Model WF-14A. **\$186.00**

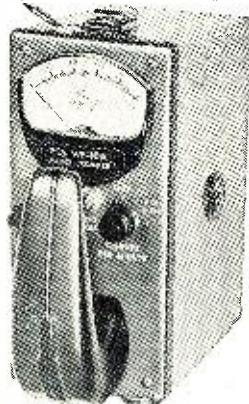

**Three-Way Radiation Detection**

- by meter
- by neon light
- by headphone

**Full-Vision Easy-to-Read Meter**

**Three Counting Ranges\***

- 0- 100 } counts
- 0- 1,000 } per
- 0-10,000 } minute

**Handy Zero-Reset Button.**

**Portable - Radio and Flashlight Battery Operation.**

**Weather-Proof Metal Case - easy to decontaminate in field with damp cloth.**

\*The WF-11A and WF-14A have three expanded counting ranges:

- 0- 200 } counts
- 0- 2,000 } per
- 0-20,000 } minute

Visit HARVEY's new AUDIOTorium at 1123 Avenue of the Americas (Sixth Avenue)

Write for complete descriptive data and specifications. Note: All prices F.O.B., N.Y.C. Subject to change without notice. Please add estimated shipping charge. Excess will be refunded.

ESTABLISHED 1927

**HARVEY**  
**RADIO COMPANY, INC.**  
 103 W. 43rd St., New York 36, N.Y. JU 2-1500



The new Model TC-55



# New! SICO Streamlined TUBE TESTERS

**FOR** The Experimenter or Part-time Serviceman, who has delayed purchasing a higher priced Tube Tester. The Professional Serviceman, who needs an extra Tube Tester for outside calls. The busy TV Service Organization, which needs extra Tube Testers for its field men.

Speedy, yet efficient operation is accomplished by: Elimination of old style sockets used for testing obsolete tubes (26, 27, 57, 59, etc.) and providing sockets and circuits for efficiently testing the new Novel and Sub-Binar types.

• You can't insert a tube in wrong socket. Separate sockets are used, one for each type of tube base. • "Free-point" element switching system Any pin may be used as a filament pin and the voltage applied between that pin and any other pin, or even the "top-cap". • Checks for shorts and leakages between all elements. Provides a super sensitive method of checking for shorts and leakages up to 5 Megohms between any and all of the terminals. Continuity between various sections is individually indicated. • Elemental switches are numbered in strict accordance with R.M.A. specification. The 4 position fast-action snap switches are all numbered in exact accordance with the standard R.M.A. numbering system.

Model TC-55 comes complete with operating instructions and charts and streamlined carrying case.

**\$26<sup>95</sup> NET**



## C. R. T. TUBE TESTER

The new Model TV-40



- Tests all magnetically deflected tubes . . . in the set . . . out of the set . . . in the carton!!
- A complete picture tube tester for little more than the price of a "make-shift" adapter!!

The Model TV-40 is absolutely complete! Self-contained, including built-in power supply, it tests picture tubes in the only practical way to efficiently test such tubes; that is by the use of a separate instrument which is designed exclusively to test the ever increasing number of picture tubes!

### SPECIFICATIONS

Tests all magnetically deflected picture tubes from 7 inch to 30 inch types. • Tests for quality by the well established emission method. All readings on "Good-Bad" scale. • Tests for inter-element shorts and leakages up to 5 megohms. • Test for open elements.

Model TV-40 comes absolutely complete — nothing else to buy. Housed in round cornered, molded bakelite case. Only . . .

**\$15<sup>85</sup> NET**



The new Model TV-11

## TUBE TESTER



- ★ Uses the new self-cleaning Lever Action Switches for individual element testing. Because all elements are numbered according to pin-number in the RMA base numbering system, the user can instantly identify which element is under test. Tubes having tapped filaments and tubes with filaments terminating in more than one pin are truly tested with the Model TV-11 as any of the pins may be placed in the neutral position when necessary.
- ★ The Model TV-11 does not use any combination type sockets. Instead individual sockets are used for each type of tube. Thus it is impossible to damage a tube by inserting it in the wrong socket.
- ★ Free-moving built-in roll chart provides complete data for all tubes.
- ★ NOISE TEST: Phono-jack on front panel for plugging in either phones or external amplifier will detect microphonic tubes or noise due to faulty elements and loose internal connections.

**EXTRA SERVICE** — The Model TV-11 may be used as an extremely sensitive Condenser Leakage Checker. A relaxation type oscillator incorporated in this model will detect leakages even when the frequency is one per minute.

The model TV-11 operates on 105-130 Volt 60 Cycles A.C. Comes housed in a beautiful hand-rubbed oak cabinet complete with portable cover.

**\$47<sup>50</sup> NET**



# TRANS-CONDUCTANCE TUBE TESTER

The new Model TV-12

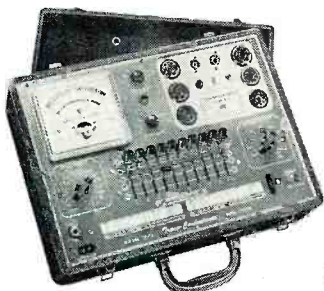

**ALSO TESTS TRANSISTORS!**

### TESTING TUBES

- ★ Employs improved TRANS-CONDUCTANCE circuit. An in-phase signal is impressed on the input section of a tube and the resultant plate current change is measured. This provides the most suitable method of simulating the manner in which tubes actually operate in Radio & TV receivers, amplifiers and other circuits. Amplification factor, plate resistance and cathode emission are all correlated in one meter reading.
- ★ NEW LINE VOLTAGE ADJUSTING SYSTEM. A tapped transformer makes it possible to compensate for line voltage variations to a tolerance of better than 2%.
- ★ SAFETY BUTTON—protects both the tube under test and the instrument meter against damage due to overload or other form of improper switching.

- ★ NEWLY DESIGNED FIVE POSITION LEVER SWITCH ASSEMBLY. Permits application of separate voltages as required for both plate and grid of tube under test, resulting in improved Trans-Conductance circuit.

### TESTING TRANSISTORS

A transistor can be safely and adequately tested only under dynamic conditions. The Model TV-12 will test all transistors in that approved manner, and quality is read directly on a special "transistor only" meter scale.

Model TV-12 housed in handsome rugged portable cabinet sells for only

**\$72<sup>50</sup> NET**

**EXAMINE BEFORE YOU BUY!  
USE APPROVAL FORM ON NEXT PAGE**



New!



# SUPER-METER

The new Model 670-A



**SPECIFICATIONS**  
 D.C. VOLTS: 0 to 7.5/15/75/150/750/1,500/  
 7,500 Volts  
 A.C. VOLTS: 0 to 15/30/150/300/1,500/3,000  
 Volts  
 OUTPUT VOLTS: 0 to 15/30/150/300/1,500/  
 3,000 Volts  
 D.C. CURRENT: 0 to 1.5/15/150 Ma. 0 to  
 1.5/15 Amperes  
 RESISTANCE: 0 to 1,000/100,000 Ohms 0 to  
 10 Megohms  
 CAPACITY: .001 to 1 Mfd. 1 to 50 Mfd. (Good-  
 Bad scale for checking quality of electrolytic  
 condensers.)  
 REACTANCE: 50 to 2,500 Ohms 2,500 Ohms  
 to 2.5 Megohms  
 INDUCTANCE: .15 to 7 Henries 7 to 7,000  
 Henries  
 DECIBELS: -6 to +18 +14 to +38 +34 to  
 +58

# SUPER-METER

ADDED FEATURE:

Built-in ISOLATION TRANSFORMER reduces pos-  
 sibility of burning out meter through misuse.

The Model 670-A comes housed, in a rugged  
 crackle-finished steel cabinet complete with  
 test leads and operating instructions.

**\$28<sup>40</sup>**  
 NET

**SHIPPED ON  
 APPROVAL  
 NO MONEY  
 WITH ORDER  
 NO C.O.D.**

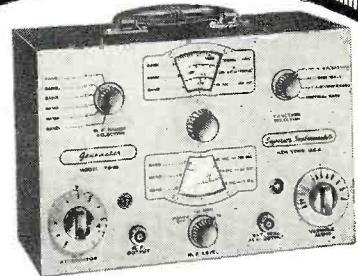

The new  
 Model TV-50

# GENOMETER

A versatile all-inclusive GENERATOR which provides ALL the outputs for servicing:  
 A.M. Radio • F.M. Radio • Amplifiers • Black and White TV • Color TV

R. F. SIGNAL GENERATOR: Provides complete coverage for A.M. and F.M. alignment. Generates Radio Frequencies from 100 Kilocycles to 60 Megacycles on fundamentals and from 60 Megacycles to 180 Megacycles on powerful harmonics. • VARIABLE AUDIO FREQUENCY GENERATOR: In addition to a fixed 400 cycle sine-wave audio, the Genometer provides a variable 300 cycle to 20,000 cycle peaked wave audio signal. • BAR GENERATOR: Projects an actual Bar Pattern on any TV Receiver Screen. Pattern will consist of 4 to 16 horizontal bars or 7 to 20 vertical bars. • CROSS HATCH GENERATOR: Genometer will project a cross-hatch pattern on any TV picture tube. The pattern will consist of non-shifting horizontal and vertical lines interlaced to provide a stable cross-hatch effect. • DOT PATTERN GENERATOR (FOR COLOR TV): The Dot Pattern projected on any color TV Receiver tube by the Model TV-50 will enable you to adjust for proper color convergence. • MARKER GENERATOR: The following markers are provided: 189 Kc., 262.5 Kc., 456 Kc., 600 Kc., 1000 Kc., 1400 Kc., 1600 Kc., 2000 Kc., 2500 Kc., 3579 Kc., 4.5 Mc., 5 Mc., 10.7 Mc., (3579 Kc. is the color burst frequency.)

MODEL TV-50 comes absolutely complete with shielded leads and operating instructions

Only

**\$47<sup>50</sup>**  
 NET

## TRY ANY

of the instruments on this or  
 on the facing page, for 10 days  
 before you buy. If completely satis-  
 fied then send down payment and pay  
 balance as indicated on coupon. No  
Interest or Finance Charges Added!

If not completely satisfied return  
 unit to us, no explanation  
 necessary.

MOSS ELECTRONIC DISTRIBUTING CO., INC.  
 Dept. D-197, 3 849 Tenth Ave.  
 New York 34, N. Y.

Please send me the units checked. I agree to pay down payment within 10 days and to pay the monthly balance as shown. It is understood there will be no finance, interest or any other charges, provided I send my monthly payments when due. It is further understood that should I fail to make payment when due, the full unpaid balance shall become immediately due and payable.

Name \_\_\_\_\_  
 Address \_\_\_\_\_  
 City \_\_\_\_\_ Zone \_\_\_\_\_ State \_\_\_\_\_

- Model TC-55 ..... Total Price \$26.95  
 \$6.95 within 10 days. Balance \$5.00  
 monthly for 4 months.
- Model TV-12 ..... Total Price \$72.50  
 \$22.50 within 10 days. Balance \$10.00  
 monthly for 5 months.
- Model 670-A ..... Total Price \$28.40  
 \$7.40 within 10 days. Balance \$3.50  
 monthly for 6 months.
- Model TV-11 ..... Total Price \$47.50  
 \$11.50 within 10 days. Balance \$6.00  
 monthly for 6 months.
- Model TV-40 ..... Total Price \$15.85  
 \$3.85 within 10 days. Balance \$4.00  
 monthly for 3 months.
- Model TV-50 ..... Total Price \$47.50  
 \$11.50 within 10 days. Balance \$6.00  
 monthly for 6 months.



THE NEW WRENCH  
WITH THE "INNER GRIP"

Preamp-Control Unit?  
(Continued from page 49)



... GRIP and DRIVE ALL  
HEX HOLLOW-HEAD  
SET SCREWS AND  
CAP SCREWS!

NO FUMBLING  
NO DROPPING



OVER 200 TYPES AND SIZES IN STOCK

WRITE FOR CATALOGUE

MANUFACTURED EXCLUSIVELY BY

MAKERS OF SPINTITES, GRIP  
SPINTITES, — FORCE-FORMED  
SOCKET WRENCHES — AND ALL  
TYPES OF MECHANICS' HAND TOOLS

FOR OVER  
**50** YEARS

**STEVENS WALDEN Inc.**  
450 SHREWSBURY STREET  
WORCESTER, MASSACHUSETTS

curves in Fig. 1, which attain a maximum boost of about 17 db at 50 cycles.

The original loudness of music generally ranges between 40 and 90 db.<sup>2</sup> In reducing gain, the lowest intensity sounds should not be brought below the level of audibility if it is desired to prevent part of the music from dropping out. At 1000 cycles the absolute audibility level in a quiet residence is 15 db.<sup>2</sup> Considering that this is the very threshold of audibility, and that one ordinarily desires music at least slightly higher than the threshold, it may be said that music should not be reduced below an absolute level of 20 db at 1000 cycles.

If none of the music is to be lost, the maximum extent of reduction at 1000 cycles is therefore 20 db, that is, a reduction from 40 db absolute to 20 db absolute. If for the sake of peace in the household one is willing to lose part of the music, an additional reduction of, say, 10 db may be introduced. This would convert orchestral peaks of 90 db to 60 db, which is in the range of conversational speech (peaks).

According to the Fletcher-Munson curves, a 20 db reduction requires in the neighborhood of 12 db boost at 50 cycles. If the reduction is from 90 to 70 db, the actual required boost is 11 db; if from 40 to 20 db, the actual boost is 12 db. This amount of boost is well within the 17 db maximum bass boost of the response curves in Fig. 1.

If gain at 1000 cycles is attenuated 30 db, then about 16-18 db of boost is required according to the Fletcher-Munson curves. The maximum bass response curve of Fig. 1 just about meets this requirement.

If gain at 1000 cycles is attenuated more than 30 db, the boost available from most bass controls would be insufficient. However, such a degree of attenuation borders on the extreme. Let us assume that at 1000 cycles gain is reduced by 40 db. This means a portion of the music would be lost. The percentage lost would of course vary with the nature of the music. Less would be lost of the "Age of Gold Polka" than of the "Afternoon of a Faun." Nonetheless, considering that the lowest level sounds of an orchestral selection would be placed 15 db below audibility, it may be inferred that the loss would be substantial in all cases. A 40 db reduction at 1000 cycles would require 24 db of bass boost at 50 cycles. Thus the response curve in Fig. 1 would fall 7 db short of providing complete loudness compensation. This deficiency of 7 db seems far less serious than the loss of a substantial portion of the music when gain is reduced 40 db.

Some loudness compensation controls have been designed to provide bass boost far in excess of that required by the Fletcher-Munson curves. For example, a control with as much

**FIRST and FOREMOST!**  
The ORIGINAL and UNMATCHED

**CapaciTester**

The pioneer instrument for checking coupling condenser leakage in the circuit!

TeleTest anticipated your demand for a unit that would check leaky coupling condensers, under load, without removal from the circuit. With the remarkable and unparalleled CapaciTester, you not only can check any coupling condenser without clipping or unsoldering leads, but you can test for leakage between any points where it may occur! AND, with the added Wien bridge, you can measure capacities from 10 mmf. to 50 mfd.



Model CT-355

1-YEAR FACTORY  
SERVICE GUARANTEE

only \$44.95\*

\* Slightly Higher West of the Rockies

- Tests all coupling condensers for leakage, regardless of type or capacity.... IN THE CIRCUIT

- Will not damage condensers
- No calibration adjustments required
- Positive indication of relative leakage amount present

**TELETEST**

See your local jobber, or write TODAY:  
**TELETEST INSTRUMENT CORP.**

31-01 Linden Place, Dept. N-1 Flushing 54, N. Y.



as 41 db boost at 50 cycles has been described and commented upon as follows: "... listening tests proved that the control does a very good job."<sup>4</sup>

However, such super bass boosters do not belong in the category of loudness compensators, whose purpose is to make reproduced music sound as much like the original as possible at a reduced level. Instead, they should be classified with echo chambers, low cut-off filters, and other special devices which may impart to music a pleasing quality, but one that was not there to begin with.

It has been shown here that a good bass control can be used as an adjunct to record equalization and as the means of loudness compensation in all but extreme cases. The question arises whether these two uses are mutually exclusive. For a bass control with as much as 17 db boost the answer appears to be essentially "no."

Table 2 shows that at 50 cycles the maximum bass boost required for record equalization is 7 db or less, leaving 10 db or more for loudness compensation. In the unusual combination of events where 1000 cycles is attenuated as much as 30 db and where a recording with the old RCA characteristics is played, there would be a 7 db deficiency at 50 cycles. On the other hand, at 30 db attenuation of 1000 cycles there would be no deficiency for the London, Columbia LP, and Columbia 78 recordings, and only a relatively minor deficiency of 3 db at 50 cycles for old AES recordings. Furthermore, it must be remembered that the hypothetical simple control unit is assumed to provide only RIAA equalization. Provision for one more phono equalization setting with greater bass boost would make it possible to supply sufficient bass in all cases.

To summarize, a simple control unit with one or two record equalization curves and without a loudness compensator, but with a good set of bass and treble controls, can handle the majority of situations in which the average home listener is apt to find himself. True, the complex type of control unit can take care of some situations where the simple unit is not completely adequate, but these situations can usually be tolerated when the added cost of a complex control unit is taken into account. In audio the last ounce of satisfaction costs considerably more than the first ounce. It seems sensible, where dollars are limited, to forget the last ounce of satisfaction in a control unit and to concentrate on improvement elsewhere, such as the speaker end, which usually leaves more to be desired.

#### REFERENCES

1. John, R. S., Jr.: "Dynamic Loudness Control," *Radio-Electronic Engineering Edition of RADIO & TELEVISION NEWS*, May 1953
2. O'Leary, M. G.: "Loudness Controls," *Radio-Electronics*, August 1953
3. Schjelderup, John R.: "A Proposed Solution to the Loudness Control Problem," *Audio Engineering*, September 1952
4. Estkowski, Michael H.: "Loudness Control," *RADIO & TELEVISION NEWS*, October 1953

-30-

January, 1956

## Your Profit Starts The Very First Day

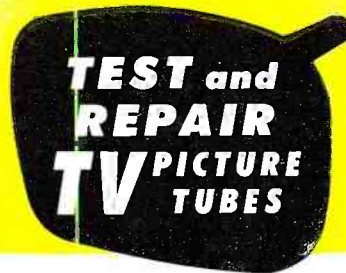

### NEW DELUXE CRT 400 with 4½" Plastic Meter

This portable Cathode Rejuvenator Tester quickly locates and corrects picture tube troubles in a few minutes, right in the home, without removing tube from set! Restores emission, stops leakage, repairs inter-element shorts and open circuits. Life-test checks gas content and predicts remaining useful tube life. Grid Cut-Off reading indicates picture quality customer can expect. Earns servicing dollars in minutes. Cuts operating costs, eliminates tube transportation. Saves money on TV set trade-in reconditioning. Pays its way from the very first day.

Weighs only 5 lbs. mounted in rugged, luggage style, carrying case covered with handsome, durable leatherette. Size: 11 x 7½ x 5".

Model 400. Net \$5495

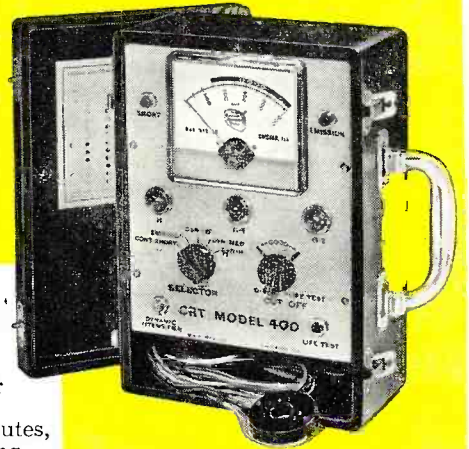

Over 20,000 CRT'S  
NOW IN DAILY USE  
ACROSS THE NATION



### NEW ECONOMY CRT 200

A quick profit maker priced low enough for every serviceman to cash in on picture tube repairs. Performs most of the functions of the CRT 400. Has 3" meter. In leatherette carrying case. Size: 11 x 7½ x 5". Weighs 5 lbs.

Model 200. Net \$3995



Send for Bulletin 101-N

**B & K MANUFACTURING CO.**  
3726 N. Southport Ave. • Chicago 13, Illinois



## TV TUNER REPAIRS 48-HOUR SERVICE

Defective tuners rebuilt to factory standards. New tuner guarantee. Ship prepaid.

### RADIO PRODUCTS CO.

15-20 122nd Street • College Pt. 56, N. Y.  
We carry a full line of Replacement Tuners for all makes of T.V.

HOME SENDING  
RECEIVING SPEED



Be a "key" man. Learn how to send and receive messages in code by telegraph and radio. Commerce needs thousands of men for jobs. Good pay, adventure, interesting work. Learn at home quickly through famous Candler System. Quality for Amateur or Commercial License. Write for FREE BOOK. **CANDLER SYSTEM CO.**  
Dept. 2-A, Box 628, Denver 1, Colo., U.S.A.

don't  
stand on your  
head!

let the  
**MASTER**  
show you the  
easy way...  
see pg. 137





# NOW HEAR THIS

for  
improved high fidelity

## GOODMANS LOUDSPEAKERS

in the New  
'Friction-Loaded'  
AXIOM Enclosures

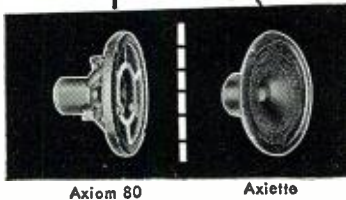
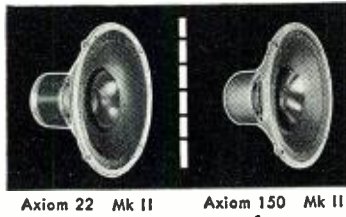

Complete do-it-yourself construction  
details — available on request

Mail this Coupon... Today

ROCKBAR CORPORATION Dept. NA-5  
215 East 37th St., New York 16, N. Y.

Please send me:

Complete information about GOODMANS  
High Fidelity Loudspeakers.

Complete details about the new 'friction-  
loaded' AXIOM Enclosures.

NAME.....

ADDRESS.....

CITY.....ZONE.....STATE.....

110

## Scope Calibrator (Continued from page 63)

with pliers. The end of the diode that corresponds to the cathode of a vacuum-tube rectifier is marked with the letter "K."

The exact value of  $R_1$  is not too important. A fifty per-cent variation is possible without much change in wave-shape. As was mentioned previously, resistors  $R_2$  and  $R_3$  are regular 5% units and are accurate enough for most applications.

Output connections from the calibrator can be made to jacks or binding posts on the scope front panel, or a push-button may be installed to connect the scope vertical input to the calibrator when the button is depressed. The 2.7 volt output from terminal "A" (see Fig. 2) is more accurate than the one-volt signal, so, it is advantageous to have both these

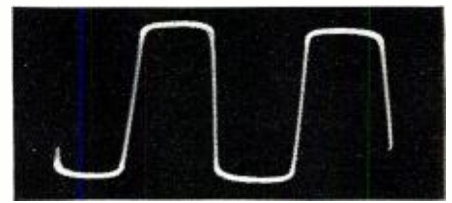

Fig. 3. Output waveform of the calibrator, fed to scope's vertical input.

signals available for calibration purposes.

### Operation

Connect the calibrator to the vertical input terminals of the scope. A square wave like the one in Fig. 3 will appear on the screen. The height of the wave represents 2.7 or 1 volt peak-to-peak depending upon which is used, output "A" or "B." If the gain is adjusted, for example, until the one-volt square wave spans ten divisions of the scope grid, the calibration is .1 volt per division.

-30-

## AN INEXPENSIVE PULSE GENERATOR

By ALVIN G. SYDNOR

**O**FTEN a need arises in the home laboratory for pulse equipment which normally can only be found in large electronic laboratories. The author, faced with this problem, constructed the pulse generator described here which serves as a useful piece of equipment and is inexpensive.

The pulse generator to be described is a simple blocking oscillator in which the trigger is an electron-coupled oscillator. The complete circuit is shown in Fig. 1. A wide range of pulse repetition rates may be obtained with the values of  $C_X$  and  $R_X$  shown in the table.

The author's unit was built in a small general purpose 4" x 4" x 2" utility cabinet. The heater and plate voltages were taken from an external source; there is no limitation on building the power supply and pulse generator on a chassis large enough to accommodate the required parts.

Tubes and resistors alone cannot produce all of the waveforms required when pulsing or starting other electronic circuits. Multivibrators can produce a nearly rectangular pulse of any adjustable or fixed duration, but they differ from many other pulse circuits in that a multivibrator determines its own cycle of operation because it uses a feedback path.

Trigger pulses are widely used for controlling the operation of various types of circuits. Most cases call for a trigger pulse of very short duration and very sharp leading edge. The trigger generator of Fig. 1 is a simple blocking oscillator which cuts itself off after a few cycles because a negative charge accumulates on the grid capacitor. Let's look at Fig. 1. Say electrons have accumulated on the capacitor  $C_X$ . They must return through the grid to the cathode coil. If the resistance is high enough to permit the grid capacitor to stay charged, we can bias the tube well into the cut-off region. Now the tube is cut off, thus the capacitor will slowly discharge through the resistance until a point is reached when the tube will start to conduct again, and this repeats over and over again.

Pulse duration of a self pulsed oscil-

lator such as this one is controlled by the grid capacitor. The value of  $R_X$  has little effect on pulse length. Changing the value of  $C_X$  will vary both repetition rate and duration.

Remember that pulse duration is the time from the leading edge to trailing edge, usually expressed in microseconds ( $\mu\text{sec.}$ ) and that pulse repetition rate is the time from the leading edge of one pulse to the leading edge of the following pulse.

An excellent article on pulses and how to work with them appears in the "Oscillographer" Vol. 14, No. 2, April-June, 1953 under the title "Techniques in Pulse Measurements" by Melvin B. Kline. Those interested in the general field of pulses should investigate this article for further information.

-30-

Fig. 1. Complete schematic diagram and parts list covering a simple pulse generator.

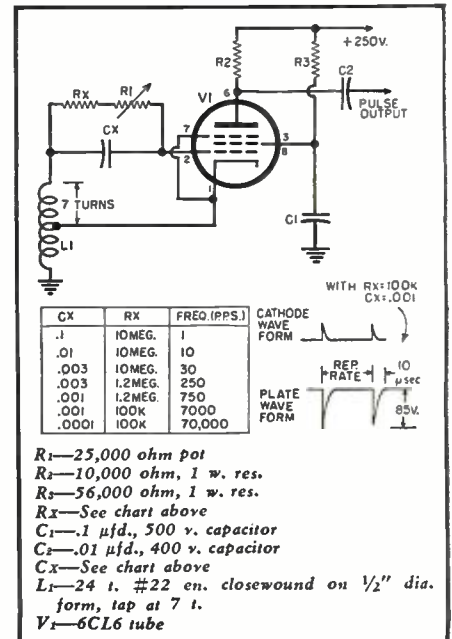

RADIO & TELEVISION NEWS



than \$4 billion annually ten years hence.

**Industrial Electronics**

Although now relatively small, the field of industrial electronics promises to become another giant in the electronics family. A figure of about \$600 million gives a fair estimate of the present size of this business. Since it is still in its initial stage, the substantial sales already achieved suggest an enormous potential. Already the list of products for electronic devices is becoming encyclopedic. Some of the more familiar applications would include the control of motors and machines, automatic elevator controls, electronic cooking, testing, sorting, closed circuit television, etc. Also significant here (although much broader in application) is the development of the transistor.

There is a strong likelihood that industrial electronics will become a billion dollar business by 1960.

**Components and Service**

Because of its magnitude, the electronics industry is able to support a sizable parts and servicing business. The value of component parts which include tubes, capacitors, transformers, speakers, resistors, etc., was in the area of \$600 million during 1954.

**Broadcasting**

Today, TV ranks third among all advertising media, exceeded only by newspaper and direct mail. In 1954, it obtained 9.9% of national advertising budgets, equal to \$809,100,000. During the current year, it is estimated that expenditures on TV advertising will surpass \$1 billion. That the industry has not yet achieved its pinnacle may be seen by looking at authoritative projections of future revenues which envision billings of \$3.5 to \$4.5 billions ten years hence.

Of course, the rapid growth of TV has displaced radio as the star medium of home entertainment. Considering that it will be able to generate revenues in the area of \$500 million annually, however, radio's contribution to the total sales picture of the electronics industry should not be underestimated.

Judging from the success it has already achieved, it appears virtually certain that the electronics industry will go on to fulfill its tremendous potential. Well out of the cradle stage now, it has exhibited an enormous vigor. Its capacity for additional growth has already been proven by its ability to rejuvenate itself through the frequent development of new facets. Perhaps of no other industry might it be said with so much certainty that it promises to maintain and strengthen its position as one of our brightest industrial diamonds.

# h.h. Scott

## AWARD WINNING AUDIO COMPONENTS

**99-B TRANSCRIPTION AMPLIFIER** — Imagine! A 22-watt amplifier with complete controls, plus a preamplifier for two magnetic inputs and at a best buy price. The 99-B has tone and loudness controls, record equalizer, tape playback provisions and record scratch and rumble filters. In practically every respect, the performance and features of the 99-B equal those of much higher priced amplifiers. **\$99.95\* net.**

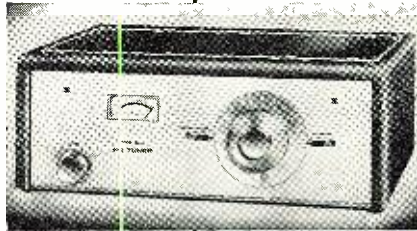
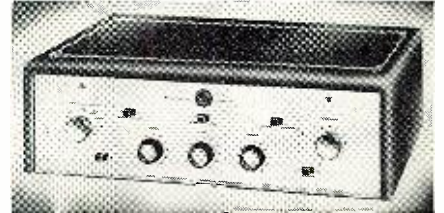

**311 FM TUNER** — Moderately priced, this FM tuner features new wide-band circuits which audio experts have called "the most significant development in tuner design for years." These circuits allow you to separate stations so close together that ordinary tuners would pass right over them. Absolutely free from drift, the 311 has 3 microvolt sensitivity for outstanding reception in even the weakest signal areas. **\$99.95\* net.**

**330 AM-FM (BINAURAL) TUNER** — An entirely new kind of AM-FM Tuner, the 330-A is the first tuner to feature truly wide-range AM plus super-selective drift-free FM. The new AM design permits the full 10 kc frequency range broadcast by better AM stations: to be received, and entirely without distortion. The new wide-band FM circuits are extremely sensitive and selective, yet are completely free from tuning drift. **\$169.95\* net.**

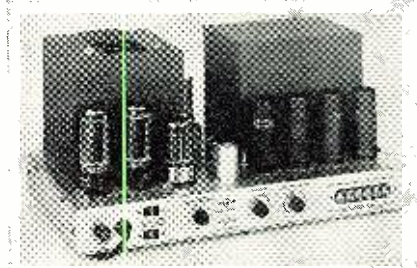
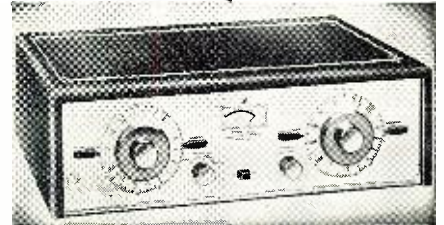

**265-A 70-watt LABORATORY POWER AMPLIFIER** — A distinguished amplifier for the perfectionist. Exclusive adjustable "Dynamic Power Monitor" control allows full output on music, with maximum speaker protection. Damping factor continuously adjustable from 30/1 to 0.5/1. Class A circuitry throughout. Frequency response flat from 12 cps to 80,000 cps. Intermodulation distortion less than 0.1%, harmonic distortion less than 0.5% at full output. **\$199.95\* net.**

**210-D DYNURAL LABORATORY AMPLIFIER** — The powerful 30-watt 210-D is the most complete amplifier made. It incorporates a flexible record equalizer, wide range controls and a preamplifier that accommodates two magnetic pickups. Features include versatile tape-recording facilities and a unique dynamic noise suppressor. This amplifier's features and refinements make it "first choice" among connoisseurs. **\$169.95\* net.**

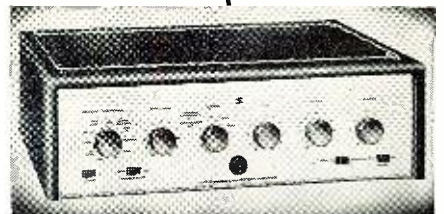

\*Prices slightly higher west of Rockies. Prices and specifications subject to change without notices.

**Engineering Leadership  
for Superior Performance**

**H. H. SCOTT inc.**  
385 PUTNAM AVENUE  
CAMBRIDGE, MASSACHUSETTS

- Professional recognition includes:**
- "Electrical Manufacturing" Award for outstanding laboratory instrument design
  - The Audio Engineering Society's award of the John H. Potts memorial medal to H. H. Scott for outstanding contributions to audio science
  - H. H. Scott amplifiers were rated "first choice" in the "Saturday Review Home Book of Recorded Music and Sound Reproduction."

Write for  
**FREE ILLUSTRATED CATALOG R 156**



# 14 TUBE ESPEY HI-FI CUSTOM FM-AM CHASSIS \$84<sup>95</sup>

LATEST 1956 MODEL WITH RESPONSE FROM 10 TO 22,000 CPS

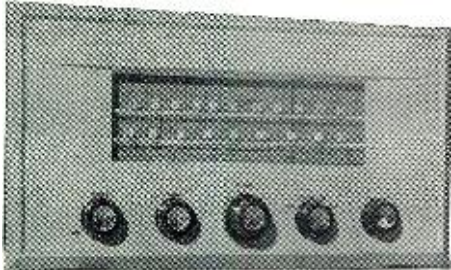

NEW MODEL HF-250C. A FULL HIGH FIDELITY AUDIO AMPLIFIER AND FM-AM TUNER—ALL ON ONE CHASSIS

- ★ PUSH-PULL 6V6 OUTPUT
  - ★ TWIN TONE CONTROLS
  - ★ INPUTS FOR CRYSTAL OR V.R. PHONO, TAPE OR TV
  - ★ WILLIAMSON TYPE CIRCUIT
  - ★ ULTRA-LINEAR RESPONSE
- PRICE **\$84<sup>95</sup>**  
LESS SPEAKER

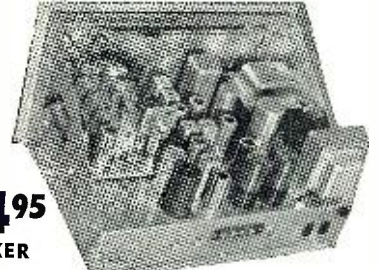

**ESPEY MODEL HF-250C**  
 With 12" Phillips Model 9760M Speaker... \$ 99.95  
 With 12" Phillips Model 9762M Speaker... 119.95  
 Buy either of these new Duotone "Norelco" speakers with your Espey chassis. Made by Phillips of Holland. Features Ticonal magnet, improved cone design, built-in mechanical crossover and copper ring fitted into air gap keeps voice coil impedance independent of frequency.  
 Model 9760M, \$54.95 list 12" Phillips speaker, response 30 to 20,000 cps, rated at 20 watts with Model HF-250C Espey chassis, both for only \$91.95.  
 Model 9762M, \$99.95 list 12" Phillips speaker, response 22 to 20,000 cps, rated at 20 watts with Model HF-250C Espey chassis, both for only \$119.95.  
 With 15" Utah Coaxial PM Speaker... \$99.95

New 1956 model, 14 tube FM-AM chassis. A true Hi-Fidelity receiver built by a nationally famous maker of fine custom chassis. Espey Model HF-250C, 14 tube FM-AM chassis with push-pull 6V6, 10 watt radio. You could spend \$200 to \$250 for a separate tuner and amplifier and not have the quality of this receiver. Ultra-Linear output used in Williamson type circuit gives frequency response of 10 to 22,000 cps. Output taps of 4, 8 and 16 ohms. Separate RF stages for FM and AM assure high sensitivity. Temperature compensated FM front end for minimum drift. Separate bass and treble tone controls. Pre-amp for all types of magnetic cartridges. 2nd input for crystal phono, tape recorder or TV. 3 position equalizer for accurate reproduction of all records. Built-in antennas for both FM and AM. Response plus or minus 1 db from 10 to 22,000 cps. Harmonic distortion less than 10%. Sensitivity: FM, 8 mv for 30 db quieting; AM, 75 mv for 6 db signal to noise ratio. Off-on-volume and equalizer are combined on a concentric control. Has 2 AC outlets on rear of chassis. Beautiful lighted flywheel inertia slide rule dial. Size: 7 3/4" x 13 1/2" x 10" deep. Ship wt. 24 lbs. (not mailed) Model HF-250C. Sale price, \$84.95. With heavy duty Utah 15" coaxial PM speaker, both for only \$99.95.

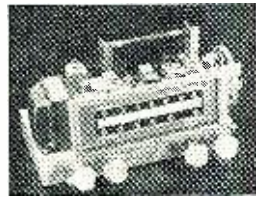

**HI-FI FM-AM TUNER AND 10 WATT P.P. 6V6 AMPLIFIER**  
 BOTH FOR **\$44<sup>95</sup>**  
 9 TUBES-PLUS 2 RECTIFIERS PHONO INPUT  
 10 W. AMP.

New Hi-Fi self-powered FM-AM tuner with 10 watt amplifier (push-pull 6V6's) on separate chassis. All you need is a record changer and speaker to have a complete home music system. 3 ft. cable connects tuner to amp. Tuner has input for crystal phono. (If changer with v.r. cartridge is purchased, we will include the necessary pre-amp, no charge.) Tuner has 6 tubes: 12AT7, 6BE6, 6AT6, 6AL5 and 6X4 rectifier. Amp has 2-6V6's, 6SN7 and rectifier. Full superhet circuit with AVC, 3 position tone control, 9" illuminated slide rule dial, escutcheon and knobs. Stick loop antenna for AM. Radio-FM-AM phono selector switch, tone control, volume control on tuner. Response 50 to 17,500 cps. Receives broadcast 540 to 1600 kc and FM 88 to 108 mc. Output matches any of the speakers shown above. No. FA9-2CR tuner and amplifier complete. Ship. wt. 22 lbs. Sale price, \$44.95. CU-14Y 12" coax speaker, \$30.00 extra; 15" coax speaker, \$20.00 extra.



**McGee's Famous 12 AND 15 INCH COAXIAL P.M. HIGH FIDELITY SPEAKERS**  
**\$12<sup>95</sup> \$23<sup>95</sup>**  
 12-Inch Model CU-14Y  
 15-Inch Model P15-CR

Model CU-14Y, 12" high fidelity coaxial PM speaker. Response from 30 to 17,500 cps. Full 6.8 ohm. Alnico V magnet in the 12" woofer. Special coaxially suspended high frequency tweeter. Built-in crossover network. Only two wires to connect to your radio or amplifier. Matches 3.2 to 8 ohm output. Don't confuse this speaker with many cheap speakers that are offered. This is a fine quality speaker. Stock No. CU-14Y. Sale price, \$12.95. 15" high fidelity coaxial PM speaker. Response down to 20 cps. and up to 17,500 cps. Full 21 1/2 ohm. Alnico V magnet in the 15" woofer. Specially made, coaxially suspended 5" high frequency tweeter. Built-in crossover network. Only two wires to connect. Matches 3.2 to 8 ohm output transformer. A regular \$62.50 list speaker. Model P15-CR, McGee's Sale Price, \$23.95.



**9-TUBE HI-FIDELITY**  
 12 Watts Audio **\$39<sup>95</sup>**  
 Dual Tone Controls  
 RECEIVES BROADCAST 550 TO 1650 K.C.

JACKSON AM9A  
 Jackson AM9A, 12 watt hi-fi audio amplifier and broadcast tuner combined. Less than you would pay for the amp alone. Push-pull 6V6's. Response 30 to 15,000 cps. Inputs for crystal or v.r. phono and crystal or dynamic mike. Separate bass boost and treble tone controls, radio-phon switch. Shielded output matches 3.2 to 8 ohm output. Heavy duty output transformer. 9 1/2" illuminated slide rule dial. 3 gang condenser with tuned R.F. and loop ant. Receives 550 to 1650 kc. Size, 13" x 9 1/2" x 6" high. With tubes: 2-6BA6, 6AU6, 6BE6, 6SN7, 6X4. Knobs, escutcheon, diagram and instructions included. Model AM9A. Ship. wt. 19 lbs. Sale price, \$39.95. CU-14Y 12" coax speaker, \$10.00 extra; 15" coax speaker, \$20.00 extra.



**WEBCOR 3 SPEED CHANGER**  
 MODEL 140-16 WITH 2 NEEDLE FLIPOVER CARTRIDGE **\$24<sup>95</sup>**

New Model 140-16, Webster-Chicago 3 speed automatic record changer with Astatic 66-TMY, 2 needle flipover crystal cartridge. Plays all 3 speeds and all 3 size records. Shuts off automatically after last record. Has neutral position to prevent damaging drive wheels when changer is not in use. 13 3/4" x 12" wide, 7 1/2" high overall, 2 1/2" below motor board and 4 1/2" above. Model 140-16. Ship. wt. 12 lbs. Sales price, \$24.95. Model 114-43 Webster-Chicago 3 speed changer with G.E. RPX-050 variable reluctance cartridge. Plays all 3 speeds. Compensating spring to shift weight of tone arm for LP and Std. records. Plug-in head will hold any popular cartridge. 14 3/4" long, 1 1/2" wide and 4 3/4" above motor board, 2 7/8" below. Available in grey, cream and high frequency finish. Ship. wt. 20 lbs. Regular net, \$48.75. Special sale price, \$38.95, less cartridge. Large 45 RPM spindle \$3.30 extra. 3/352 Collaro changer with G.E. RPX-052A "Golden Treasure" cartridge, \$58.95.

**NEW—SMALL VOLT-OHM METER**  
 2000 OHMS PER VOLT AC-DC WITH TEST LEADS  
 2 FOR \$19.50—4 FOR \$37.00

McGEE SC003  
 SALE PRICE **\$9<sup>95</sup>**

New, small Volt-Ohm meter 5 1/2" tall, 3 5/8" wide and 1 1/2" thick. 3 1/4" meter. Sensitivity 2000 ohms per volt. DC volts 0 to 1000 in 5 ranges; AC volts 0 to 1000 in 5 ranges; DC current 0 to 500 ma. in 3 ranges; Resistance 2 chms to 1.5 megohms in 3 ranges; Decibels minus 20 to plus 16 (0db, 77.4 volts). A thin, compact instrument small enough to fit in your service kit. A fine imported meter specially priced at \$9.95 for this Radio & TV News ad. Never before have we offered an instrument value like this. Model TP-5, complete with test leads. Sale price, only \$9.95. Ship. wt. 2 lbs. Special quantity price, 2 for \$19.50, or buy 4 for only \$37.00.

**MINIATURE BROADCASTING STATION FOR MICROPHONE AND PHONO WITH CRYSTAL MICROPHONE**  
 SALE PRICE **\$9.95**

Sensational new model MCL-E3 miniature broadcasting station for microphone and phonograph. Can be used as any broadcast radio in the home. No wires to connect, tubes to operate, one control fades from microphone to record. Frequency can be adjusted so as not to interfere with local radio stations. Miniature broadcast station, complete with crystal hand mike and instructions. Ship. wt. 4 lbs. Net price \$9.95.

**6-TUBE, 2-BAND RADIO KIT \$14.95**  
 6-18 MC 550-1650 KC

6 tube, 2 band AC-DC radio kit, complete with speaker and plastic cabinet. Popular with schools and colleges for training in radio. Receivers broadcast and 3-18 mc shortwave. Full 2 gang superhet with 5" speaker and slide rule dial. A complete kit with tubes: 12K8, 2-12SK7, 12SQ7, 50L6 and 35Z5, diagram and instructions. Cabinet 13" x 6 3/4" x 6 1/4". Ship. wt. 12 lbs. Model ME6-2, Net \$14.95.

**REGULAR \$65.00 LIST COLLARO 3 SPEED HI-FI CHANGER**  
 Imported from England Sale Price **\$38<sup>95</sup>**  
 Less Cartridge

Regular \$65.00 list Collaro Model 3/532, 3 speed automatic record changer made in England. Intermixes 10" and 12" records of the same speed. Constant speed reluctance cartridge. 14 1/2" long, 1 1/2" wide and 4 3/4" above motor board, 2 7/8" below. Available in grey, cream and high frequency finish. Ship. wt. 20 lbs. Regular net, \$48.75. Special sale price, \$38.95, less cartridge. Large 45 RPM spindle \$3.30 extra. 3/352 Collaro changer with G.E. RPX-052A "Golden Treasure" cartridge, \$58.95.

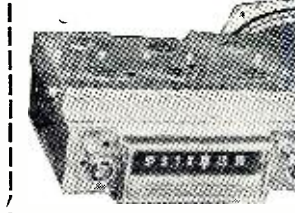

**6-TUBE, 6-VOLT UNIVERSAL MOUNTING AUTO RADIO**  
 WITH **\$19<sup>99</sup>** 6" x 9" SPEAKER

McGee makes another tremendous purchase and passes the saving on to you. This universal mounting, 6 tube, 6 volt auto radio is a full superhet with fully tuned R.F. stage. Made to sell at a much higher price, by one of America's best known manufacturers. Its very thin and compact construction lends it to a neat underdash installation in most any car or truck. Or you can arrange a place in the dash for custom installation. (Dial requires a cut-out 5 1/2" long x 2 1/2" high; two control holes on 7" centers. A minimum of 6 3/4" depth behind dash.) Wheel mounted underdash it extends only 2 1/4" below. Overall size 9" wide, 4 1/4" high and 7 1/4" deep. Requires no more room under your dash than an ordinary auto radio remote control head. Not intended for an exact custom panel fit, but it lends itself very well to your custom installation ideas. Can be custom fit in most late model cars and trucks. Has no built-in speaker, but is furnished with a heavy duty 6x9" speaker. This is the most popular size auto radio speaker. Tubes: 6BE6, 2-6BE6, 6AV6, 6AQ5 and 6X4. Ship. wt. 12 lbs. Stock No. AH-759. McGee's Sale Price, \$19.99 for the radio complete with 6x9" speaker, 3 section cow antenna, \$2.29 extra.

**McGEE RADIO COMPANY**  
 PRICES F.O.B. KANSAS CITY SEND 25% OR FULL REMITTANCE WITH ORDER. BAL. SENT C.O.D. TELEPHONE VICTOR 5092 1903 MCGEE ST., KANSAS CITY, MISSOURI



# AMERICA'S FINEST VALUES IN "LOW COST" HIGH FIDELITY

## ECONOMY 20 WATT AMPLIFIER \$22.95

**NEW 1956 MODEL**  
 Push-Pull 6L6 Output Tubes  
 Response 30-15,000 CPS  
 Bass and Treble Tone Controls  
 Input for Xtal or Dynamic Mike  
 Input for Xtal or V.R. Phono

With CU-14Y, 12" Coax Speaker... \$32.95  
 With P15-CR, 15" Coax Speaker... \$42.95  
 With Imperial IV System... \$39.95  
 With SP-12125CR... \$44.95  
 With HF-33GE... \$69.95

A tremendous High Fidelity amplifier value. Response 30 to 15,000 cps. Electronic bass and treble boost by separate tone controls. Use this amplifier with any push-pull changer having crystal or variable reluctance cartridge, radio tuner or high impedance crystal or dynamic microphone. 20 watts power output. Use with any 4 or 8 ohm speaker or 250 ohm line. Chassis size, 7 3/8" x 10 1/2" x 7 3/8" high. Complete with tubes: 2-6L6, 2-6X4, 12AU7, 12AF6. This is a terrific value. A ready to use high fidelity amplifier at less than the cost of a kit. Ship. wt. 17 lbs. Model HF-20, 20 watt Hi-Fi amplifier, McGee's sale price, \$22.95.

## CONSOLE HI-FI SPEAKER SYSTEM \$49.95

**12" G.E. PM WOOFER-10" PM MID-RANGE-8" G.E. MODEL 850 MID-HIGH RANGE SPEAKER AND 600 CYCLE L-C CROSSOVER NETWORK.**

Have Juke Box tone quality in your own home. Strictly High Fidelity. Three speakers all connected to a 600 cycle frequency dividing network, so that only 2 wires feed the system from any 4 or 8 ohm radio or amplifier. A variable tone compensating control incorporated in the circuit makes brilliant highs or boomy lows to your own taste. Any amplifier that you now have will give you a much wider selection of acoustical arrangements with this speaker system. The 3-way system is shipped ready to connect to your amplifier or hi-fi radio. Equipped with a General Electric 12" woofer, an 8" famous G.E. 850 plus a 10" middle range speaker. Frequency response 30 to 15,000 cps. Take your choice of cabinets: blonde oak, walnut or mahogany. (Specify finish desired when ordering) 37" high, 24" wide and 20" deep. Ship. wt. 75 lbs. Stock No. HF-33GE. Sale price, \$49.95. Model HF-44GE, console speaker system, same as above except has a heavy duty 12" G.E. PM Model 1201, plus 8" G.E. PM Model 850, 10" mid-range speaker and 5" hard cone tweeter. Sale price, \$54.95. (Specify cabinet finish.) Model HF-55GE, super deluxe quality console speaker system, same as HF-33GE described above, except has 15" G.E. PM Model 850, 10" mid-range speaker and 5" hard cone tweeter. Sale price, \$54.95. (Specify cabinet finish.) Model HF-55GE, super deluxe quality console speaker system, same as HF-33GE described above, except has 15" G.E. PM Model 850, 10" mid-range speaker and 5" hard cone tweeter. All 3 systems incorporate 600 cycle L-C type crossover network with variable tone compensating control. Model HF-55GE. Sale price \$69.95 (specify cabinet finish).

## DELUXE CONSOLE SPEAKER SYSTEM \$89.50

**15" UTAH WOOFER-8" GE-2-5" TWEETERS-CROSSOVER**  
 New, deluxe quality High-Fidelity console speaker system. Has 15" Utah woofer with 21 oz. Alnico V magnet, 8500 cps. mid-range speaker and two Utah tweeters. This is the finest console speaker system that we offer. Available in blond oak or natural mahogany finish. Cabinet size, 43" high, 31" wide and 23" deep. Has 34" length doors with attractive hardware and ornament on grill below doors. All 4 speakers are connected to a 600 cycle frequency dividing network, so that there are only 2 wires to connect to any 4 or 8 ohm output of your radio or amplifier. Has variable tone compensating control built-in. Model HF-15CR, deluxe quality Hi-Fi console speaker system. Ship. wt. 100 lbs. (Specify cabinet finish desired.) Sale price, \$89.50.

## NEW IMPERIAL IV with General Electric 8 in. HIGH FIDELITY SPEAKER \$19.95

New 1955 Model IMPERIAL IV, High fidelity speaker system with General Electric 8" speaker. Housed in a high quality leatherette covered plywood cabinet 10" x 10" x 2 1/2". Fully enclosed; covered on all sides except back. Use as an auxiliary speaker or with any high fidelity radio, amplifier or home music system. The IMPERIAL IV contains a General Electric model 850, 600 cycle frequency dividing network, with 6.8 oz. Alnico V magnet and curvilinear cone with 8 ohm voice coil and a 5" tweeter. Response 50 to 15,000 cps. Model IV Imperial \$19.95. Ideal for use with HF-20 and IMP-30 amplifiers described above.

## FAMOUS STANDARD COIL CASCODE TUNERS

TV-2000 series Standard Coil cascode tuners complete with 6J6 and 6BK7 or 6RQ7 tubes. Thousands of TV sets are using our tuners. Tuner 12 channels (2 thru 13). For I.F. circuit. This tuner will give 2 to 1 better reception than the old pentode type. Many servicemen replace an older tuner with our cascode model. Available with either 27 1/2" or 4 1/4" shaft length. A tremendous purchase makes our low \$12.95 price possible. Specify shaft length desired. Stock No. TV-2000-3. 2 FOR \$25.00. Sale price \$12.95 each, 2 for \$25.00. Matching knobs for Standard Coil tuners. Set No. SCK-2 for fine tuning and channel selector. Set VCK-2, matching volume and contrast knobs. Either set only 55¢ a pair.

## TWO-TUBE SARKES-TARZIAN TV TUNER WITH TUBES \$7.95 EA., 2 FOR \$15.00

No. TT-3A, 2 tube Sarkes-Tarzian 12 channel TV tuner. 21-25 mc. Popular in many makes. Ideal for general replacement use too. Has 6J6 and 6BC5 tubes. Used in CBS, Arvin, Crosley, etc. Makes a good replacement for one tube tuners. 3 1/2" shaft. Takes SCK-2 knob set described above. Sale price, \$7.95 each, 2 for \$15.00 with tubes.

## 3-STATION MASTER SUB-STATIONS \$3.95 EACH \$16.95

Powerful 3 station master. Chrome plated metal case 7 1/2" x 6" x 5". 3 tube AC-DC amp. Press-to-talk switch on top. Volume control, switch and station selector on front. 3-Station Master is ideal when it is pressed at sub. Use with one to 3 subs. Model MPM-F3, Ship. wt. 10 lbs., \$16.95. Matching sub-station PM-AS, with matching knobs for Standard Coil tuners. \$3.95 ea. 3 for \$10.00. Requires 3 wire intercom cable, \$1.95 per 100 ft., 500 ft. for \$8.95.

## TELEVISION BOOSTER CLEARANCE SALE

Clearance sale on VHF television boosters for channels 2 through 4. RMS Model WP-10, chrome case, brown winkle finish. Continuously variable tuning, GAKS tube. Ideal for late model sets with cascode front end. Sale price, \$4.95. RMS Model SP-6, brown plastic case. Same as SP-5 except has variable control. (Picture.) Sale price, \$4.95. McMurdo-Silver GB-6B continuously variable, includes FM band, 6J6 tube, brown plastic case. Sale price, \$5.95. Standard Coil B-51 printed circuit booster. Sale price, \$6.95. GAKS tube, brown plastic case. Sale price, \$6.95.

# McGEE RADIO COMPANY

## IMPERIAL 30 WATT AMPLIFIER \$29.95

**NEW 1956 MODEL**  
 Push-Pull 6L6 Output Tubes  
 Response 15-20,000 CPS  
 Bass and Treble Tone Controls  
 Compensated Gain for G.E. Cart.  
 Input for Xtal or Dynamic Mike

With CU-14Y, 12" Coax Speaker... \$39.95  
 With P15-CR, 15" Coax Speaker... \$49.95  
 With Imperial IV Speaker System... \$46.95  
 With SP12125CR... \$51.95  
 With HF-33GE... \$76.95

New 1956 model 7 tube Imperial 30 watt High Fidelity audio amplifier. A \$100.00 list value for only \$29.95. Features a heavy 4 lb. specially wound high fidelity output transformer with 15% inverse feedback; push-pull 6L6 output tubes and frequency response from 15 to 20,000 cps. Matches 8 or 16 ohm speakers. You can center your entire custom music system around this low cost 30 watt amplifier. This Imperial 30, 30 watt amplifier may be used with any radio tuner or record player. It will drive any speaker system that you may have. Use from one to ten 8" speakers or any 12" or 15" coaxial speaker or any 3-way speaker system. Tone compensated input for either a crystal phono pickup or a General Electric variable reluctance pickup. Also, has input for crystal or high impedance dynamic microphone. 4 controls are mike gain, phono gain, treble tone and bass boost tone control. This amplifier weighs 21 lbs. net. Full size transformer components would cost you up to \$15.00 if purchased separately. Gold color chassis is 12 1/2" x 7 3/4" x 7 1/4" high. Complete with tubes: 6AT6, 6AU6, 6CA, 12AU7, 2-6L6A plus 5U4G rectifier. Stock No. IMP-30, 30 watt Imperial High-Fidelity amplifier complete with tubes and diagram. Ship. wt. 23 lbs., Sale price only \$29.95.

## 25 WATT HI-FI SPEAKER SYSTEM

**2-12" Woofers SALE PRICE**  
**2-5" Tweeters**  
**Power Supply and L-C Crossover Network \$24.95**

25 watt, High-Fidelity Dynamic Speaker System complete with 2000 cycle genuine inductance-capacitance cross-over network, two 12" woofer speakers, two 5" high frequency tweeter speakers and separate 110 volt AC power supply for only \$24.95. Frequency response 20 to 18,000 cps. Both the woofers and tweeters are fine quality dynamic speakers with fields excited to saturation by the power supply. Tweeters are specially made with cones designed to respond only to the high frequencies of the audio spectrum. The 2000 cycle cross-over network prevents frequencies below 2000 cps from entering the tweeters and eliminates frequencies above 2000 cps from the woofer circuit. The cross-over network system is simple to connect to any 4 or 8 ohm output of your high fidelity audio amplifier or radio. No. SP-12125CR, High Fidelity Dynamic Speaker System. Ship. wt. 15 lbs. Sale price, \$24.95. No. SP-12125, High Fidelity Dynamic Speaker System, as described above, but less the 2000 cycle cross-over network and with a separate attenuator control. Sale price, \$14.95. Ideal for use with HF-20 and IMP-30 amplifiers described above.

and the tweeters are fine quality dynamic speakers with fields excited to saturation by the power supply. Tweeters are specially made with cones designed to respond only to the high frequencies of the audio spectrum. The 2000 cycle cross-over network prevents frequencies below 2000 cps from entering the tweeters and eliminates frequencies above 2000 cps from the woofer circuit. The cross-over network system is simple to connect to any 4 or 8 ohm output of your high fidelity audio amplifier or radio. No. SP-12125CR, High Fidelity Dynamic Speaker System. Ship. wt. 15 lbs. Sale price, \$24.95. No. SP-12125, High Fidelity Dynamic Speaker System, as described above, but less the 2000 cycle cross-over network and with a separate attenuator control. Sale price, \$14.95. Ideal for use with HF-20 and IMP-30 amplifiers described above.

## HIGH FIDELITY SPEAKERS

**5" BLUE STREAK TWEETER.....\$ 2.95**  
**8" BLUE STREAK.....\$ 6.95**  
**15" BLUE STREAK WOOFER.....\$16.95**

Model HF-8J, 8" "Blue Streak," High Fidelity wide range speaker. This one speaker properly baffled will cover an area of 100 sq. ft. with high and low frequencies and terrific response through the very important middle range. Has 6.8 oz. Alnico V magnet with wide range curvilinear cone and 8 ohm voice coil. Response essentially flat from 35 to 12,500 cps. Perfect for high fidelity radios, amplifiers and professional music systems. Ship. wt. 6 lbs. Model HF-8J. Sale price, \$6.95. Model HF-15WF, new 15" "Blue Streak" Hi-Fi woofer. Has 21 1/2 oz. Alnico V magnet with one piece cone and 1 1/2" x 8 ohm voice coil. Will give excellent response from 50 to 9500 cps. Takes 18 to 25 watt peak. Ship. wt. 12 lbs. Sale price, \$16.95.

## NEW-LOW COST HIGH FIDELITY MICROPHONES

Special Sale! Model M28-KT, high quality imported crystal microphone. Very trim and neat in appearance. Polished chrome case 1 1/2" x 5/8" thick with clip on back and 5 ft. shielded plastic cable. Hi-Fi response, comparable or better than lapel microphones selling for \$10 to \$15 net. Shipped with 3 connector, one piece cone and 1 1/2" x 8 ohm voice coil. A fine addition to any tape recorder or audio amplifier. Stock No. M28-KT, Sale price, \$3.99.

Deluxe Model M14-KT, High Fidelity imported crystal microphone for use with any amplifier or tape recorder. Attractive brilliant finish is a combination of polished chrome and opalescent tan lacquer. Has full swivel head and 5 ft. shielded plastic cable. A fine addition to any amplifier or tape recorder. Comparable to microphones selling for \$15 to \$25 net. Shipped with plugs to fit most recorders and amplifiers. Stock No. M14-KT, Sale price, \$7.95. Fits standard 5/8" mike stand.

Model M20-KT, all purpose crystal microphone. Hi-Fi response. A terrific imported value. Comparable or better than microphones selling for \$10 to \$12 net. Fits standard 5/8" mike stand. Shipped with pin plug, phone plug and screw-on connector. Stock No. M20-KT, Sale price, \$4.95.

## AIR KING FM-AM TUNER SELF POWERED \$24.99

Use with any Audio Amplifier

**SALE PRICE \$24.99**

Air King factory built, 6 tube self-powered FM-AM radio tuner. Receives broadcast 540 to 1620 kc and FM 88 to 108 mc. Use with any Hi-Fi audio amplifier or connect it to your TV set for FM-AM reception. Selector switch has 4 positions for TV-Phono-FM and AM. 3 other controls are volume-off-on, tone and tuning. With tubes: 12AT7, 2-6AU6, 6AL5, 6XQ7, and 5Y3 rectifier. Chassis size, 11 1/2" x 7 1/2" x 6 1/2" high. Illuminated slide rule dial 7 1/2" x 2 1/2", with escutcheon plate and knobs. Self-powered with its own power transformer. Air King FM-AM tuner chassis No. 703 as used in Air King model 17K1C combination TV-Radio-Phono with power supply added. Note: A separate audio amplifier is required to operate a speaker. Stock No. AIR-K6, self-powered FM-AM tuner, complete with tubes, knobs and diagram. Ship. wt. 10 lbs. Sale price, \$24.99.

## PRICES F.O.B. KANSAS CITY TELEPHONE VICTOR 5092

SEND 25% OR FULL REMITTANCE WITH ORDER. 1903 MCGEE ST., KANSAS CITY, MISSOURI BAL. SENT C.O.D.



# Super Savings on HI-LITE TUBES

- all tubes branded Hi-Lite and dated
- individually boxed in attractive red and black cartons
- fully guaranteed for 1 year
- all Hickok mu tested to insure satisfaction

**ANY TUBE 43<sup>c</sup> ea.**

0Z4	6AQ6	6V6	12SK7
1R5	6AT6	6W4	12SL7
154	6AU6	6W6	12SN7
174	6AV6	6X4	12SQ7
1U4	6AX4	6X5	25L6
1U5	6BA6	6Y6	25W4
3AL5	6BC5	7C5	25Z5
3AU6	6BF5	7C6	25Z6
3BC5	6C4	7F7	35A5
3CB6	6CS	7N7	35B5
3Q5	6CB6	7Q7	35C5
354	6F6	12AL5	35L6
3V4	6H6	12AT6	35W4
SU4G	6I5	12AU6	35Y4
SV4G	6K6	12AU7	35Z5
5Y3	6K7	12AV6	50A5
5Z3	6S4	12AX4	50B5
6AB4	6SA7	12BA6	50C5
6AG5	6SJ7	12BE6	50L6
6AL5	6SL7	12AZ7	50Y7
6AQ5	6SN7	12SA7	117Z3
	6SQ7	12SJ7	

**ANY TUBE 64<sup>c</sup> ea.**

1B3GT	6BA7
1LA6	6BC7
1LB4	6BD5
1LC5	6J6
1LC6	6SR7
1X2	6T8
6AC7	6V3
6AG7	6X8
6AF4	12AV7
6AK5	12BH7
6AU5	12BZ7
6AV5	12BY7
6AH4	12SR7

**ANY TUBE 75<sup>c</sup> ea.**

6AM8	6CD6G
6AN8	6CU5
6BG6G	6CF6
6BK5	19AU4
6BK7	19T8
6BL7	19BG6G
6BQ6	25BQ6
6BQ7	25AV5
6BN6	117L7
6BZ7	117Z6

**INDOOR ANTENNA** List Price \$9.95  
with brass dipoles dial selector Sale Price \$3.59

**PICTURE TUBES** \$1.20 per inch

**PICTURE TUBE BRIGHTNER** .85 ea.

**TERMS:** Shipments F.O.B. Irvington, N. J. Please send full amount and allow for postage. We refund excess money. 25% deposit required on C.O.D.'s, 75c service charge on orders under \$5. Subject to prior sale.

**HI-LITE**  
ELECTRONIC SALES CO.  
37A 18th Avenue • Irvington 11, N. J.

## New Hi-Fi-Audio Equipment

### 10-WATT AMPLIFIER

Challenger Amplifier Co. is now offering a 10-watt amplifier, the Model HF8A, which has a frequency response of 30 to 20,000 cps  $\pm$  1 db.

The HF8A features a three-position phono equalizer for RIAA, 78, and POP equalization curves. A bass tone con-



trol provides an 8 db boost at 50 cps while a treble control provides for 18 db attenuation at 10,000 cps.

The amplifier may be used with low-level magnetic cartridges as well as crystals and ceramics. It is adaptable to both open shelf and custom cabinet installations since it is supplied with a removable etched-brass front panel.

Write the company at 29 Ninth Ave., New York 14, N. Y., for additional specifications on this unit.

### MARION VU METER

Marion Electrical Instrument Company has developed a new vu meter which has joined the firm's line of "Medalist" panel instruments.

The new unit has the characteristic "medallion" shape which provides increased readability and legibility. The

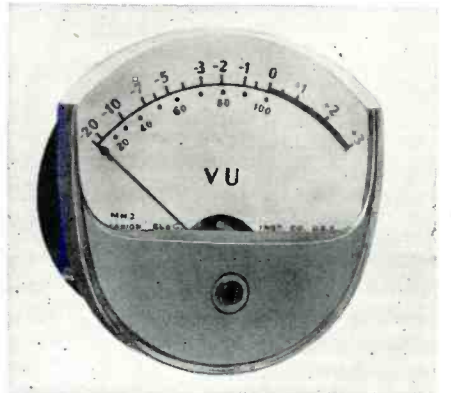

clear Plexiglas case construction results in virtually shadow-free dial illumination by admitting light from the top and sides as well as from the front.

The Model MM2VU meets the latest ASA specification C16.5-1954 for volume measurements of electrical speech and program waves and is designed to

RADIO & TELEVISION NEWS

WRITE FOR THIS

**FREE**  
LIFETIME  
HI-FIDELITY  
Sales Kit

DEALER  
SALES KIT  
MAKE BIG  
HI-FI PROFITS

Sell the finest HI-FI Units for custom building or in BEAUTIFUL CABINETS... Sell BE-LOW REGULAR WHOLESALE PRICES with full dealer mark-up and with price protection.

TRANSVISION Hi-Fi Equipment is  
SOLD THRU SELECTED DISTRIBUTORS  
TRANSVISION, INC., NEW ROCHELLE, N. Y.  
In Canada: 1338 Queen St. W., Toronto 3, Ont.

TRANSVISION, INC., New Rochelle, N. Y. RN-1  
Rush FREE Dealer SALES KIT on HI-FI and name of nearest distributor.

Name \_\_\_\_\_  
Address \_\_\_\_\_  
City \_\_\_\_\_ State \_\_\_\_\_

**LEARN TV**  
the practical way..



BUILD the New  
TRANSVISION  
TV KIT

Designed so that  
COLOR can be added

\$15<sup>00</sup>  
ONLY gets you started\*

- PROFIT 3 WAYS:
- 1 Learn TV
  - 2 Save up to 50%
  - 3 Prepare for COLOR TV

Shows 8 Great TV Kits:

EXCLUSIVE: Only Transvision TV Kits are adaptable to UHF. Ideal for FRINGE AREAS. No Previous Technical Knowledge required. Write now!

**FREE**  
CATALOG

**TRANSVISION**  
THE OLDEST NAME IN TV KITS  
NEW ROCHELLE, N. Y.

MAIL THIS COUPON TODAY -  
TRANSVISION, INC., NEW ROCHELLE, N. Y. Dept. RN-1

- I'm enclosing \$ \_\_\_\_\_ deposit. Send standard kit PACKAGE #1, with all Instruction Material. Balance C.O.D.  
 Send FREE copy of your new TV Kit Catalog.

Name \_\_\_\_\_  
Address \_\_\_\_\_  
City \_\_\_\_\_ State \_\_\_\_\_



be used where the precise indication and measurement of a.f. voltages is required in broadcast, monitoring, recording, and hi-fi applications.

The company will supply full details on this instrument if you will write them at Manchester, N. H.

### FM ANTENNA LINE

Technical Appliance Corporation is offering a new series of FM antennas in its "Taco" line.

One of the units is the "Omni-directional S-type" antenna which provides a nearly perfect circular directivity pattern. This antenna has a broadband folded dipole tuned to cover the entire FM band. Matching the conventional 300-ohm transmission line, the antenna delivers maximum signal to the receiver terminals. By having the driven element at ground potential, a simple and effective lightning protection feature is provided automatically. The Model 624L is a single antenna and the two-stacked version which provides added gain has been designated as the Model 624ST-L.

The Models 644 and 645 are single- and two-bay units designed for fringe reception of FM signals.

The firm, located in Sherburne, N. Y., will supply additional data on this line upon request.

### RECORD AND TAPE RACK

Leslie Creations has come out with a "Stack-a-Rack" unit which is designed to accommodate 45 rpm records and recorded tape packages.

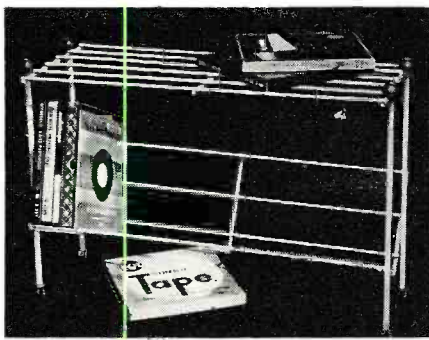

The "Stack-a-Rack" features a unique "expansion" principle in that the top corner supports are fitted with sockets that accommodate the legs of another rack. Several racks may be stacked in this manner to become an inexpensive room divider. Legs are rubber tipped.

Measuring 22" x 14" x 9" over-all, the rack will hold either 225 single 45 rpm records, more than 160 LP albums, or over 30 recorded tape or 45 rpm album boxes.

Write the company at P.O. Box 9516, Dept. 308, Philadelphia 49, Pa., for prices on these racks.

### GRANCO CONSOLETTA

Granco Products Inc., 36-07 20th Ave., Long Island City, N. Y., has recently expanded its radio line to include a radio-phonograph consolette, the Model RP-1000.

The new instrument is cabined in a wood veneer housing and includes an

(Continued on page 116)

## SAVE HOURS OF WORK

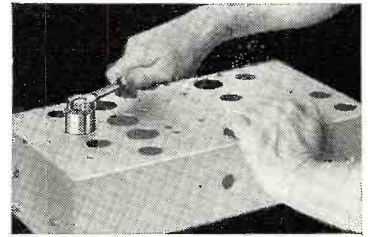

quickly make round, square, key and "D" openings with Greenlee Radio Chassis Punches

In 1½ minutes or less you can make a smooth, accurate hole in metal, bakelite or hard rubber with a GREENLEE Punch. Easy to operate . . . simply turn with an ordinary wrench. Wide range of sizes. Write for details. Greenlee Tool Co., 1881 Columbia Ave., Rockford, Ill.



# New TELEVISION COURSE

Amazing Bargain, Complete, Only \$3

### NEW PRACTICAL COURSE

Here is your complete training in television servicing. Amazing value at only \$3, full price. These new lessons cover every fact, adjustment, and repair of all types and makes of TV receivers. Giant in size, mammoth in scope, topics just like correspondence courses selling for over \$150.00. Our amazing offer permits you to obtain the course complete for only \$3.

### SIMPLIFIED TV TRAINING

New, easy-to-follow, well illustrated 14 lessons on circuits, picture faults, adjustments, short cuts, about UHF, alignment, antenna problems, troubleshooting, service hints, how to use test equipment. Many large practical sections prepared by leading manufacturers. Recently published. Send trial coupon right now. Prompt shipment.

### COVERS EVERYTHING IN TV

Let these course-lessons take you into TV servicing the easy way. The very first lesson of this sensational course tells how to do simple repairs. You can start earning money immediately. Second lesson tells you what is wrong, by just looking at the picture—no instruments used. Lesson 4 has 32 large, 8½x11" pages and 28 helpful illustrations on antennas. Also 12 full lessons on trouble-shooting, alignment, UHF, test equipment, picture analysis, and all types of new circuits. With this new course you will find yourself doing TV repairs in minutes—instantly finding faults. Most amazing bargain. You are invited to examine. Send no-risk coupon.

### Companion RADIO COURSE

Here is your complete radio training in 21 easy-to-follow lessons. Covers fundamentals, fault finding, test equipment. Everything in radio. Introduction to television. New 1955 edition. Special price, only \$2.50.

Just Out



### RADIO and TV Manuals

Your complete, best source for all needed RADIO and TV diagrams and servicing data. Most amazing values. Still sold at pre-Korean prices. Only \$2 to \$3 per volume. Every Radio manual contains large schematics, all needed alignment facts, parts lists, voltage values, trimmers, dial stringing, and many repair hints. Each TV volume is a practical treatise on servicing a full year's sets, with giant diagrams, waveforms, hints, alignment and voltage charts, production changes. See coupon at right for a complete list of these low-priced Supreme Service Manuals.

**Supreme Publications**  
Sold by All Leading Parts Jobbers

January, 1956

### NO-RISK TRIAL ORDER COUPON

### SUPREME PUBLICATIONS, 1760 Balsam Rd., Highland Park, ILL.

#### Radio Diagram Manuals

Most-Often-Needed Series (See full description at left)

- New 1955 Radio Manual, \$2
- 1954
- 1953
- 1952
- 1951
- 1950
- 1949
- 1948
- 1947
- 1946
- 1942
- 1941
- 1940
- 1939
- 1926-1938 Manual, \$2.50
- Radio and TV Master Index, 25¢

These annual RADIO volumes specially priced at only **\$2.50** each . . .

**THIS GROUP ONLY \$2 EACH**

- Rush today TV and Radio manuals checked  below and at left. Satisfaction guaranteed or money-back.
- New Television Servicing Course, complete. . . \$3.
- Radio Servicing Course (all 21 lessons) . . . \$2.50
- Additional 1955 TV, \$3.       Early 1955 TV, \$3.
- 1954 TV Manual, \$3.       1953 TV Manual, \$3.
- 1952 Television Manual, \$3.       1951 TV, \$3.
- 1950 Television Manual, \$3.       1949 TV, \$3.
- 1948 TV, \$3.       1947 TV & FM, only \$2.

- I am enclosing \$ . . . . . Send postpaid.
- Send C.O.D. I am enclosing \$ . . . . . deposit.

Name: .....

Address: .....



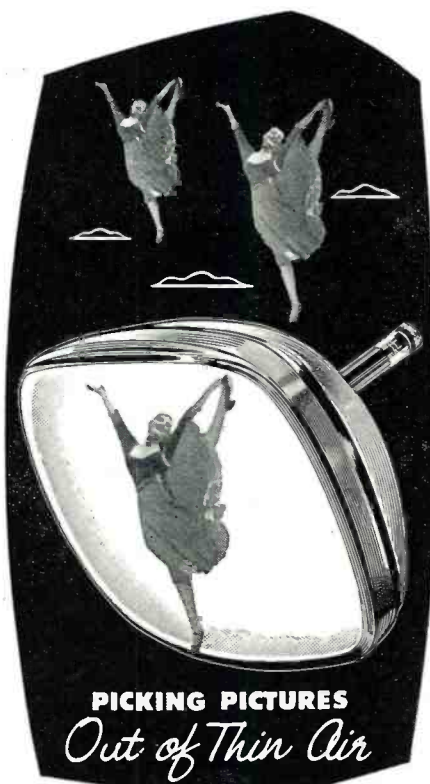

**PICKING PICTURES**  
*Out of Thin Air*

## TUNG-SOL®

### Magic Mirror Aluminized PICTURE TUBE

That electronic miracle, your TV set, picks a world of entertainment out of the air at the fantastic speed of 120 pictures a second!

Leading TV set manufacturers depend upon Tung-Sol Magic Mirror Aluminized Picture Tubes and Receiving Tubes to deliver the exacting performance their engineering standards demand.

This use is indicative of the quality and dependability of Tung-Sol Tubes . . . products of America's largest independent electron tube manufacturer.

**TUNG-SOL ELECTRIC INC.**  
Newark 4, N. J.

Sales Offices: Atlanta, Chicago, Columbus, Culver City, Dallas, Denver, Detroit, Newark, Seattle. Canada: Montreal.

### Tung-Sol Automotive & Electronic Products

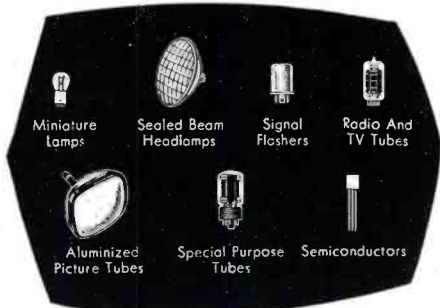

FM-AM tuner, the company's coaxial-tuning unit, and amplifier. The set uses



two speakers and incorporates a three-speed automatic record changer.

At present the Model RP-1000 is available in either mahogany or limed oak finishes.

### AMPRO "CONSOLETTES"

Ampro Corporation, 2835 North Western Ave., Chicago 18, Illinois, has two new model "Consolettes" tape recorders in its line.

Designed to fit into any home decor, the Models 757M and 757B are offered in either Honduras red mahogany or "Primavera" blonde wood finished cabinets. Space is provided in the cabinet for over 45 hours of tape programming.

The recorders include electronically-balanced, two-speaker systems; amplifier bypasses for high-fidelity hookups; extended frequency response from 40 to 12,500 cps; two speeds for both record and playback (7½ ips and 3¾ ips);



electromagnetic piano-key controls; automatic selection locators; and electron eye level indicators.

### "BIFLEX" SPEAKERS

Altec Lansing Corporation, 161 Sixth Avenue, New York 13, N.Y. is now offering three new loudspeakers which have been designated as "Biflex" units.

The most interesting feature of the new speakers is their use of multiple concentric compliances. The speaker not only has compliance at the outer edge, but an additional compliance approximately midway down the slope of the cone.

Presently available are the 8" Model 408A with a guaranteed frequency range of 60 to 13,000 cps; the 12" Model 412A which covers from 40 to 13,000 cps; and the 15" Model 415A which offers coverage from 30 to 13,000 cps. Write the company for full details on this new line.

### SPINET-TYPE ORGAN

Electronic Organ Arts, 4878 Eagle Rock Blvd., Los Angeles 41, California, has added another build-it-yourself kit to its line of electronic organs.

The new spinet type features modern styling, compactness and portability. The organ kit includes a full-size 61-note organ manual and a 13-note pedal keyboard with a master volume control pedal.

The nineteen stops include several couplers plus a variety of solo and ensemble voices. The electronic components feature the latest in printed cir-



cuitry. Although there is space in the console for loudspeakers, if desired, the organ is designed to operate through the owner's audio system.

Write for full details on this "Artisan Spinet Electronic Organ" kit direct to the manufacturer.

### "SELF-CABINETED" UNITS

Bell Sound Systems, 555 Marion Rd., Columbus 7, Ohio has announced that its Model 2122-C, 2199-B, and 2200-C amplifiers are now being offered with an optional satin-finish gold cover for those who wish a "cabineted" unit.

The cover houses the entire deck area of the amplifier, presenting a neat, modern appearance. The entire front face of the cover is a grille of perforated metal, while the back is entirely open for maximum ventilation. A pilot light is provided on all three models. The company will supply complete data on this "Series G" line of amplifiers, on request.

### 4-SPEAKER SYSTEM

Sight and Sound Electronics Co., 167 Depot Road, Huntington Station, L.I., New York is now offering a new 4-speaker system which is being marketed as the "Fidelio."

The four speakers are mounted in a hand-crafted enclosure finished in mahogany, natural birch, or walnut. The infinite baffle type enclosure requires no tuning or adjusting of any kind.

Response from 37 to 17,000 cps is



# Now...a new magazine!!! audiocraft

for the tinkerer—the experimenter—in home music reproduction who wants to know how to do it himself.

by the publishers of  
**High Fidelity**

A PERFECT COMPLEMENT TO "The Magazine for Music Listeners"...

A slick, exhilarating, and elegant new monthly which will appeal particularly to those many thousands of home-music, home-radio, home-TV and home-recording hobbyists who are hard-bitten by the urge to experiment with their high fidelity installations and systems. Semi-technical, do-it-yourself material about hi fi for those who want basic, practical and reliable information on sound recording and reproduction. For the man with brains, curiosity and energy, absorbed with a desire to work with sound apparatus, and not to be frightened off with a diagram or two. A Magazine for the alert, progressive sound enthusiast. Much needed... long awaited... published by experts in the field of home music and high fidelity listening... 35¢ a single copy—1 year subscription \$3.50, 2 years \$6.50, 3 years \$9.00.

IN EACH ISSUE  
Practical Audio Design,  
Sound Servicing,  
How They Did It,  
Audionews,  
Tips for Woodcrafters,  
Basic Electronics,  
Tape News and Reviews.  
and

many more informative, clearly detailed articles, diagrams, and illustrations.



A 3 year subscription saves you \$3.60 over single-copy price.

**SEND IN THIS COUPON TODAY!**

**AUDIOCRAFT Magazine** 5013 Publishing House, Great Barrington, Mass.

Please enter my subscription to AUDIOCRAFT.  Remittance enclosed.  Please bill me.

3 years \$9.00      2 years \$6.50      1 year \$3.50  
 (36 issues)       (24 issues)       (12 issues)

NAME \_\_\_\_\_  
ADDRESS \_\_\_\_\_

Add \$1 per year for subscriptions outside U.S. and Canada

## FREE GIFT COUPONS

FREE COUPON for exciting gifts for every dollar you spend on Electrical appliances, etc. for use in home, save over counter. Send for FREE PREMIUM CATALOG... order now... start collecting these valuable coupons!

## FREE GIFT COUPONS

- 900,000 Radio TV Tubes
- Individually Boxed
- One year RTMA guarantee
- Best brands available
- Same day service

## TUBE SPECIALS SAVE TUBES

To Feb. 1st

**19¢ EACH**

**1F5G 49**  
**12Z3 2C22**  
**16Z9 35/51**

Disregard Main Tube List!



**FREE** with each \$25 or more order! S-Pc. Sylvania Repair Kit. Value \$4.95. Includes: flashlight head, Phillips screwdriver, flat head screwdriver, alignment tool and polystyrene case.

### FREE WITH \$3 order or more!

Practical, All Purpose ELECTRIC TESTER. Equipped with genuine GE neon glow lamp. Tests loads from 90 volts to 500 volts, AC or DC. Use it in the home, factory, shop, garage, etc.

**TERMS:** 25% deposit required on all orders, balance C.O.D. Save C.O.D. charges, send full remittance plus postage with order. All unused money refunded with order. NO MINIMUM ORDER.

TYPE	PRICE	TYPE	PRICE	TYPE	PRICE
6Z4	.45	6BH6	.53	706	.46
1B3GT	.79	6BJ8	.49	7F8	.70
1L8	.51	6BK5	.70	7Y4	.35
1L8	.51	6BK7A	.78	12AT6	.61
1LA4	.57	6C6	.59	12AT7	.68
11R4	.69	6C17GT	.77	12AU6	.46
11E6	.65	6CG6T	.80	12AU7	.58
11D5	.57	6CQ7A	.80	12AV6	.42
11E3	.57	6E2	.20	12AX7	.83
11A5	.59	6EY5G	.48	12BY7	.50
11M4	.46	6C4	.39	12DA6	.46
11A5	.47	6C5	.38	12E4	.70
11A5GT	.55	6C6	.51	12KE8	.46
1R4	.46	6C86	.61	12BH7	.60
1R3	.51	6CD6G	1.28	12BY7	.64
154	.53	6E6	.50	12SA7	.52
1E5	.51	6E5	.46	12SH7	.61
1T4	.61	6F6	.40	12S7GT	.50
1U5	.50	6H6GT	.40	12SQ7	.50
1V	.57	6I4	2.00	12SL7GT	.61
1X2A	.62	6J5GT	.40	12SN7GT	.57
20Z1	1.00	6J6	.49	12SQ7GT	.40
2V4G	.94	6I7	.47	14W5	.39
2X2A	.90	6K6GT	.39	14A7	.45
3D6	.45	6K7	.40	1486	.40
6AF4	.59	6L7	.44	14Q7	.52
3Q4	.55	6N7	.61	19B6G6	1.18
3Q5GT	.63	6Q7	.45	19J6	.66
3V4	.58	6E4	.48	19T8	.70
5T4	.70	6S7G	.47	25A7GT	1.50
5U4G	.49	6SA7GT	.50	25AV5GT	.80
5V4G	.71	6SC7	.50	25L6GT	.48
5Y3GT	.39	6S7	.43	25BQ6GT	.82
5Y4G	.43	6SH7	.45	25Y5	.45
5Z3	.45	6S17GT	.45	25Z5	.42
5Z4	.54	6SK7	.50	25Z6GT	.42
6A7	.59	6SL7GT	.70	35A5	.48
6A8	.59	6SN7GT	.57	35B5	.48
6AB4	.45	6SQ7GT	.44	35C5	.48
6AF4	.80	6V6GT	.48	35L6GT	.48
6AG5	.52	6W4GT	.40	35W4	.39
6AH6	.80	6W6GT	.53	35Y4	.40
6AK5	.40	6X4	.35	35Z7	.41
6AL5	.42	6X5	.39	35Z6GT	.39
6AL7GT	.70	6X5GT	.35	50B5	.48
6A55	.50	6X8	.75	50C5	.48
6A56	2.00	6Y6	.60	50L6GT	.48
6A57G	2.25	7A4	.47	75	.44
6AT6	.40	7A5	.55	77	.39
6AU5GT	.70	7A6	.47	78	.39
6AU6	.43	7A7	.45	80	.35
6AV5GT	.75	7A8	.46	83V	.60
6AX5GT	.59	7B5	.41	117L7GT	2.00
6B4G	.90	7B7	.43	117N7GT	2.00
6BA6	.49	7B8	.47	117P7GT	2.00
6BC5	.50	7C4	.40	117Z3	.37
6BE6	.46	7C5	.44	117Z6GT	.65
6BG6	1.18				

**WELLER DUAL-LITE SOLDER GUN KIT**  
100 watt gun provides the proper heat for most applications. Dual spotlight illuminates work. Kit includes Solder Gun, Soldering aid, Kester solder. **\$5.83**

**Pocket AC-DC MULTITESTER**  
Hi-accuracy precision VOM-1000 Ohms per V. Reads AC & DC volts 0, 5, 25, 250, 1000 V. DCWR: 0.1, 10, 100 MA. Ohms 10, 100 K. Size: 1 1/2" D, 4 3/4" L, 3/4" W. Test Leads. Sold Singly \$9.95. Lots of 3..... **\$9.45**

- Sheldon Picture Tube Brightener..... Lots of 3, **\$1.09**
- 5K-50K-100K-500K-200K, 1 meg. less switch. Your choice ea. **19¢**
- TV deflection yoke. New type for anti-anastigmatic focusing. **\$2.99**
- Standard Coil CASCODE TV TUNERS..... ea. **\$13.95**
- Long Shaft, 41 C. complete with 6J6, 6Q7, 12 channel (2 to 13). Long shaft can be cut. **\$1.29**
- UNIVERSAL 4-prong Auto Radio Vibrator..... ea. **89¢**
- For 90% of 6 volt auto sets. **\$1.39 ea.**
- 25 asst. knobs for radio, TV, auto work..... each kit **\$2.49**
- GE TYPE FLYBACK TRANSFORMER..... ea. **19¢**
- 14.5 KV Flyback, use with 6BG6 or 6CD6, 12 to 14.5 KV. ea. **59¢**
- UL approved. Double outlet. Molded rubber plug. **\$3.86**
- 6 FT. EXTENSION CORD..... ea. **89¢**
- VISULITE TV TUBE CHECKER AND CONTINUITY TESTER..... ea. **59¢**
- Automatically checks all tubes, tests electrical devices such as fuses, lamps, resistors etc. **\$1.95**
- TUBE SOCKET KIT..... ea. **89¢**
- 25 asst. octal, loctal, 7 pin, 9 pin miniature in bakelite and wafer type. Complete..... ea. **59¢**
- TERMINAL STRIP KIT..... ea. **1.95**
- 10 asst. most wanted type for radio, TV. Complete..... ea. **1.95**
- INSULATED RESISTOR KIT..... ea. **1.95**
- Asst. of 100 1/2 watt, 1 watt, 3 watt resistors RTMA color coded. Handy plastic utility kit. List \$15.80..... each kit **1.95**
- BIG SAVINGS! SPEAKERS**
- 4" PM-Matching output transformer..... **\$1.57**
- 6" PM-\$2.29 ea..... **\$2.00**
- 8" PM-For radios, small PA systems, \$3.49 ea..... Lots of 10, ea. **\$3.29**
- 12" PM-Jumbo Alnico 5 magnet, \$5.50 ea..... Lots of 8, ea. **\$4.50**

**Stanley ELECTRONICS CORP.**  
Dept. RN-1  
835 MAIN AVENUE - PASSAIC, N. J.  
Gregory 1-2498



**DOUBLE  
YOUR  
PLAYING  
TIME**

WITH NEW **irish** BRAND **Double-Play** RECORDING TAPE



**Double-Play**  
the newest of the **irish** Ferro-Sheen process premium tapes is made on DuPont's strong, tough, miracle film—Mylar. A 7" reel gives you 2 hours of continuous recording at 3 3/4 ips (4 hours dual track). Recommended for all applications requiring long, uninterrupted operation and where tape tension is not excessive.

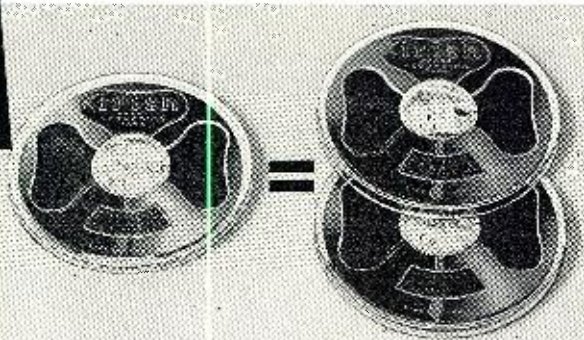

**One 7" Reel of New irish Double-Play Tape Has As Much Playing Time - 2400 Feet - As Two 7" Reels of Ordinary Tape!**

2400' on standard 7" reel.....\$7.50 Hi-Fi Net

If not available at your dealer, order direct from:  
**ORRADIO INDUSTRIES, INC.**  
Opelika 2, Alabama  
World's Largest Exclusive Magnetic Tape Manufacturer  
Export: Morhan Exporting Corp., N.Y.C.  
Canada: Atlas Radio Corp., Ltd., Toronto

assured. Each speaker is a full-range 9" unit and requires no crossover network for complete audio coverage.

**CRESTWOOD RECORDER**

Daystrom Electric Corp., 753 Main Street, Poughkeepsie, New York, is currently marketing a new magnetic tape recorder, the Crestwood "Concerto Model 360".

Basically a table model unit, it is unique in that accessory legs screw in the base to convert it to an armchair-height console. Decorator-styled wood cabinets are offered in mahogany and blonde finishes. The woofer and tweeter speaker system is properly baffled to reproduce the full music range.



Push-button control, a printed circuit preamp, and a 10-watt power amplifier are additional features of the unit.

The company will supply complete specifications on request.

**McINTOSH 60-WATT UNIT**

McIntosh Laboratory, Inc., 320 Water Street, Binghamton, New York, has



added a 60-watt amplifier to its line of audio equipment.

The Model MC-60 incorporates a new patented circuit which delivers 60 watts of power with less than 1/2 of 1 per-cent distortion from 20 to 20,000 cps. Frequency coverage is from 20 to 30,000 cps. Output impedances of 4, 8, 16, and 600 ohms are provided. The amplifier measures 14 1/4" x 10" x 8" and is of chassis-type construction.

The amplifier is designed to be used with the company's C-4, C-8, or other preamplifiers.

**SCOTT AM-FM TUNER**

Herman Hosmer Scott, Inc., 385 Putnam Ave., Cambridge 39, Mass. is marketing a new AM-FM tuner, the Type 330-A.

**10 Major Works**

- TO INTRODUCE YOU TO THE MIRACLE OF TRUE HIGH FIDELITY RECORDINGS
- BACH**  
Tocatta and Fugue in D Minor
  - CHOPIN**  
Fantasie-impromptu, Opus 66
  - BEETHOVEN**  
Piano Sonata No. 24 in F Sharp, Opus 78
  - MUSSORGSKY**  
Night on Bald Mountain
  - VIVALDI**  
Concerto in C for Two Trumpets and Orchestra
  - MOZART**  
Symphony No. 26 in E Flat, K. 184
  - BRAHMS**  
The Academic Festival
  - BERLIOZ**  
The Roman Carnival
  - WAGNER**  
Die Meistersinger, Prelude, Act 1
  - DUKAS**  
Sorcerer's Apprentice

**COMPLETE TO THE LAST NOTE!**  
Yes, all works complete on two EXTRA-Long Playing discs.  
**\$1**  
Take all 10 for just one dollar!

try them **FREE**

Don't pay until AFTER you've heard them.  
**No Strings Attached!**  
No purchase obligation. Full membership privileges.

Performed by world-famous artists and orchestras. Custom recorded on quiet vinylite with full range high-fidelity—50 to 15,000 cycles! Now, take all these 10 Masterpieces for free home trial! After 5 days send only \$1 as payment in full for all 10, or return them. We make this amazing offer to show you the quality of our recordings and acquaint you with our no obligation Membership plan. See coupon for details, and mail today—without money—for your 10 Masterpieces.

The Musical Masterpiece Society, Dept. 47-1  
43 West 61st Street, New York 23, N. Y.  
Rush 10 Masterpieces for free trial. After 5 days I'll send only \$1 plus shipping or return them. Enroll me as Trial Member. Privileges: No purchase obligation ever. Advance notice of releases. Free trial on any disc. May return any disc. May cancel membership at any time. For future l.p. discs I keep I'll pay only \$1.65 plus shipping.

Name .....

Address .....

City..... Zone..... State.....  
Canada: 105 Bond Street, Toronto 2, Ont.

**NEW—Best Buy in Hi Fi**  
**Grammes**  
**Build-it-Yourself Kits**

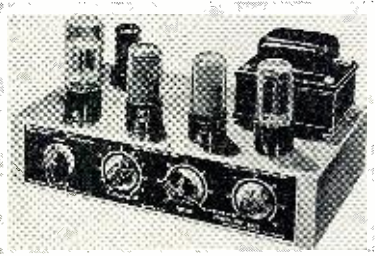

**The Famous Lille Jewel \$21.95 NET**  
**MUSIC LOVERS AMPLIFIER**

Most popular hi-fi amplifier in its field, featured by Life Magazine.

Enjoy . . . Building Your Own.  
Most complete set of instructions.

Sold only through selected distributors.  
SEND COUPON FOR NAME OF DISTRIBUTOR IN YOUR AREA

Grammes Division of Precision Electronics, Inc.  
9101 King Ave., Franklin Park, Ill.

Rush name of nearest distributor.

Send L.J. Kit. Enclosed find \$5.00, balance and postage C.O.D.

Send L.J. Kit postage-paid. Enclosed find \$21.95.

Name .....

Address .....

City..... Zone..... State.....  
10-day money back guarantee on all kits.



The new unit features wide-range, distortion-free AM, and highly selective, sensitive, drift-free FM performance. The new AM design permits the full 10 kc. frequency range broadcast by better AM stations to be re-

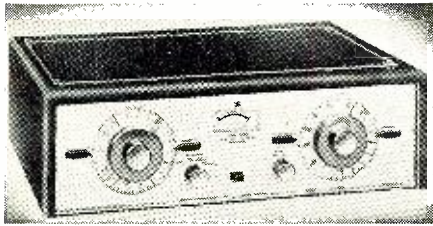

ceived. The 3-position i.f. bandwidth switch allows wide range, normal, or distant reception. The wide-band design provides extra sensitivity on FM and eliminates drift. Full 80 db rejection of spurious cross-modulation response by strong local signals is also offered.

A free bulletin on this new tuner is available on request.

#### RONETTE CARTRIDGE

Not new, but still of considerable interest to hi-fi fans, is the 284 series of cartridges imported from Holland by *Ronette Acoustical Corp.*, 135 Front St., New York 5, N. Y. Model TO-284P is particularly designed for high quality reproduction. According to the company, this cartridge will equal, if not outperform in many cases, present-day magnetic units. It is a low-priced crystal type with turnover operation

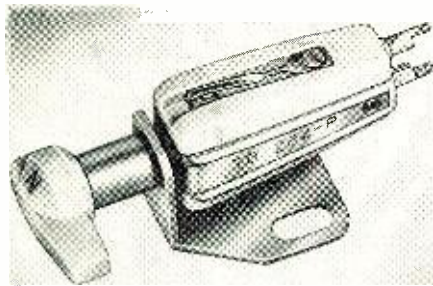

for both LP and 78 rpm recordings.

Its greatest feature is in the fact that it has a very low value (less than 1% according to the company) of intermodulation distortion even at high stylus velocities. In addition, the extremely small mass and high compliance of the moving system contribute to its ability to track even at the extreme stylus velocities. It has a constant velocity response and will drive a power amplifier with a sensitivity of .75 volt to full output.

Write direct to *Ronette Acoustical Corp.* for information on this and on other cartridges in the line.

#### "PLUG-IN" ADAPTER

The *Audak Co.*, 500 Fifth Ave., New York 36, N.Y. is in production on a new instant "Plug-In" adapter that permits any of its cartridges to be connected to any *Garrard* record player.

The connector was designed specifically for the *Garrard* RC-80M and RC-

**COYNE**  
trains you for  
big pay jobs  
in...

# TELEVISION

-RADIO in shops of COYNE  
...or in  
spare time at HOME

A fascinating field! A great future! A good job or independence in a business of your own! TV is growing by leaps and bounds—1227 new communities, 1845 new stations given "go-ahead". Trained men are worth their weight in gold!

#### COYNE HAS TRAINED MORE SUCCESSFUL MEN

Thousands of successful men trained at COYNE—the largest, oldest, best-equipped school of its kind (established 1899). A Coyne-trained man is a top-trained man. Coyne methods require no advanced education or previous experience.

#### TRAINING TAILORED TO MEET YOUR NEEDS

**Resident Shop Training**—You can learn on real equipment in the Great Shops of Coyne. Learn quickly—easily at Coyne. Practical Technical method gives practical experience on massive outlay of full-size equipment plus necessary technical training. Finance Plan whereby you can enroll now and pay most of tuition later. Also Monthly Payment Plan especially designed for K-Vets. If you need part-time work to help out with living expenses while at COYNE, we'll help you get it. Coupon brings FREE BOOK and details.

#### OR

**Coyne Tested Home Training**—To those who cannot come to the Coyne shops here in Chicago, we offer modern, up-to-the-minute training designed to meet Coyne standards. Practical, down-to-earth, easy to follow, step-by-step instruction. So practical, you can quickly be earning money in

B. W. COOKE, President FOUNDED 1899

**COYNE**  
ELECTRICAL SCHOOL  
A TECHNICAL TRADE INSTITUTE OPERATED NOT FOR PROFIT  
500 S. Paulina Street, Chicago 12, Dept. 16-TR5  
ELECTRICITY • RADIO • TELEVISION • REFRIGERATION • ELECTRONICS

#### No. 47 RADIO PANEL BULBS:

25	100	500	1,000
\$1.00	\$3.00	\$13.50	\$25

Minimum order \$1. Bulbs are quality imported, fully guaranteed. Send 25% dep., we ship C.O.D. for bal. Write for bargain parts catalog; prices F.O.B. Boston.

**GLOBE ELECTRONICS**  
200 Washington St., Boston 8, Mass.

#### TEST EQUIPMENT REPAIRED

Contractors to U. S. Government  
Repairs and calibration by skilled craftsmen on all makes of Meters, Testers, Sig. Gens., V. T. V. M's, Scopes. Our twentieth year. Prompt service. Low factory prices. Stock of Genuine parts. All work guaranteed. Write for estimate or ship P. P. Ins. to:

**DOUGLAS INSTRUMENT LABORATORY**  
Electronic Instrument Repairers  
176 Norfolk Avenue Boston 19, Mass.

Television and Radio while learning—personal supervision by Coyne Staff—men who know TELEVISION AND RADIO, AND KNOW HOW TO TEACH IT—and the cost is low—you pay only for training—no costly extras. Send coupon below for Picture Folder and full details, including easy Payment Plan.

#### MAIL COUPON FOR FREE INFORMATION

Fill in and mail coupon. TODAY. Check the training you're interested in. If you want information on both, check both. Complete details will come by return mail. No cost—No obligation—No salesman will call.



B. W. COOKE, President  
COYNE ELECTRICAL SCHOOL  
500 S. Paulina Street, Chicago 12  
Dept. 16-TR5

Send details of your offer on training checked below. This does not obligate me and no salesman will call. I am interested in:

- TELEVISION-RADIO HOME TRAINING
- TELEVISION-RADIO IN COYNE SHOPS

Name .....

Address .....

City ..... State .....

#### Send For Our Latest Catalogue

Illustrating 39 Professionally Designed and Engineered Kits

- AM/FM Tuner • FM Tuner
- Television • HI-FI Amplifier
- Geiger Counter • Test Equipment
- Long and Shortwave Radio Kits
- Experimenters Construction
- Phonographs and Record Changer

## ARKAY KITS

WORLD'S FINEST  
RADIO PHONOGRAPHS TV  
TEST EQUIPMENT HI-FI  
Write for FREE Brochure

RADIO KITS, INC. • 120 Cedar St., N. Y. 6



# Rauland

"GOLDEN SERIES"

## HIGH FIDELITY

Custom  
Quality  
Hi-Fi  
Components



Sensibly  
Priced  
for  
Everyone

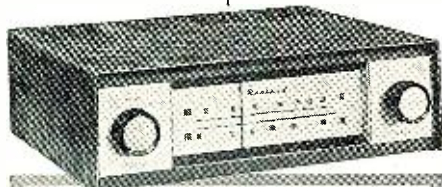

*Golden Star* MODEL HF255  
AM-FM TUNER

Provides exceptional AM-FM reception, true high fidelity realism with "space-saver" convenience and beauty at remarkably low cost. FM response,  $\pm 0.5$  db, 20 to 20,000 cycles; AM,  $\pm 4$  db, 20 to 5,000 cycles. Sensitivity: FM—5 microvolts for 20 db of quieting; AM—20 microvolts for 1 volt output. Includes AFC, drift-compensated circuits, FM di-pole antenna, AM ferrite loop, etc. Only  $3\frac{1}{2}$ " high. Ideal for use with amplifier below.

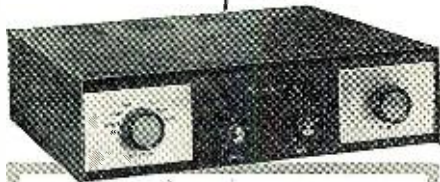

*Golden Chief* MODEL 1512  
12-WATT  
HIGH FIDELITY AMPLIFIER

True hi-fi performance at moderate cost. Full 12 watts output; response,  $\pm 0.5$  db, 20 to 20,000 cps. Features 5 inputs; separate bass, treble controls; equalization for EUR, ffr, RIAA, Quiet; variable damping control, choice of volume control or loudness control. In compact cabinet, only  $3\frac{1}{2}$ " high.

### BEAUTIFUL "SPACE SAVER" DESIGN

RAULAND matching Hi-Fi units are decorator-styled in handsome charcoal black with marbled gold finish, control panels in soft brushed brass. Designed to fit anywhere—no cabinets required. (Extension shafts available for behind-panel mount.)



Hear these RAULAND units at your  
Hi-Fi dealer, or write for details

RAULAND-BORG CORPORATION  
3515 W. Addison St., Dept. B, Chicago 18, Ill.

90 changers and for the Model "T" turntable. Provision is made for maintaining the all-important stylus-to-groove alignment. No soldering or wire handling is required.

Additional details on this adapter are available from the manufacturer.

### NEW RCA PICKUP

The Tube Department, *Radio Corporation of America*, Harrison, N.J. has unveiled its new developmental wide-range, dynamic-type phonograph pickup which offers several features of interest to the audiophile.

Among the unique properties of the device are the elimination of the need for external damping material in the suspension and the use of a new-type coil which produces a more uniform magnetic field for smooth signal output. The pickup has a frequency response extending to 20,000 cps.

### NEW LITERATURE

#### E-V MIKE CATALOGUE

*Electro-Voice, Inc.*, Buchanan, Mich-

igan is now offering a colorful, illustrated catalogue covering its line of microphones.

Detailed application information, features, and specifications on each of the firm's microphones used in telecasting and broadcasting is included in this 32-page publication. The booklet also shows how these microphones work, and includes polar patterns, frequency response curves, and wiring diagrams.

Please specify Catalogue No. 120 when writing for this publication.

### MAGNETIC TAPE

*ORRadio Industries, Inc.*, Opelika, Alabama, maker of "Irish" brand recording tape, is offering an interesting new folder which completely describes and illustrates every step in the manufacture of magnetic recording tape.

Entitled "How Magnetic Tape is Made," this booklet will be sent to interested persons without charge. Address all requests for this booklet to Department 120 of the firm. —50—

### "BUILD YOUR OWN" COMPUTER AVAILABLE

THE scope of "do-it-yourself" projects is a continual source of amazement to those who have been keeping track of the trend for the past few years.

Today's prospective home owner is positively casual about whipping up his own roof and installing the necessary wiring and plumbing.

This same trend toward handling the more complex "do-it-yourself" projects has now extended into the field of electronics. The Heath Company has just introduced a relatively inexpensive electronic analog computer in kit form which will provide a real challenge to the electronic hobbyist.

The unit was not designed simply as a challenge to the home technician but serves a real purpose in universities and industries where the cost of an elaborate commercial instrument is not justified but where an accurate instrument is required.

This table-model unit incorporates 30 coefficient potentiometers, each of which is capable of being set to an accuracy of better than 1/10th of 1 per-cent; a standard reference supply for all d.c. volt-

ages; a nulling meter for accurate setting of computer voltages; and a patch-board layout which enables the operator to "see" his computer block layout.

The computer cabinet, shown in the photo below, houses all of the electronic components comprising the computer. It will handle 15 amplifiers; 30 coefficient potentiometers, 2 auxiliary 10-turn potentiometers; 6 floating initial conditions; and 4 dual bias diodes. The amplifier, power supply, and initial conditions circuits come as individual chassis to be assembled into the cabinet. The function generator is housed in a separate self-contained cabinet.

While the company doesn't recommend that this unit be built as a "first project" by the beginner, the student engineer or more advanced technician can assemble this unit by following the step-by-step instructions and pictorial diagrams which accompany the project.

Although the price of this kit has not been finally determined as yet, according to the company, it will sell for under \$700. Distribution is scheduled for some time prior to March 31st of 1956. —50—

Over-all view of the Heath electronic analog computer now available in kit form.

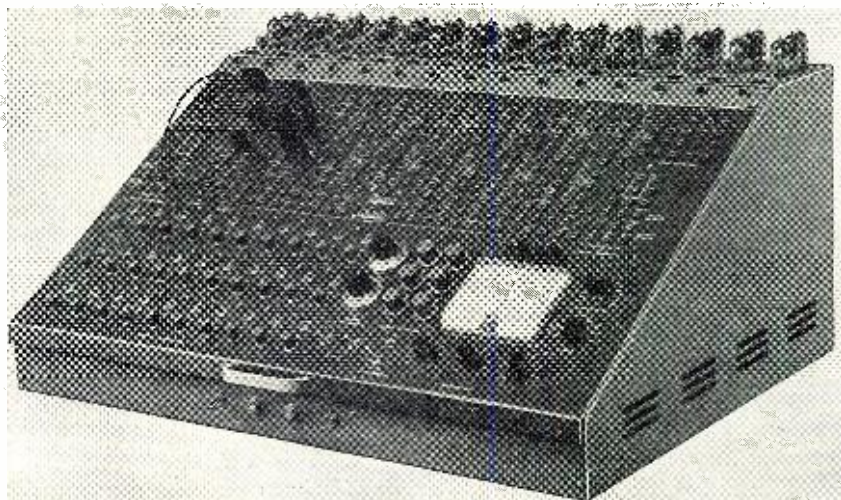



## CLIFF DWELLER'S ANTENNA

By K. E. HUGHES, W6CIS

THE accompanying diagram of the author's "Four-Band Cliff Dweller's Antenna" is self explanatory and might be of interest to other readers.

Let me say at the outset that such an antenna will not replace a good three-element beam on 20 or a 60-foot high doublet on 80; however, considering the space, cost, and ease of adjustment, it gives a very good account of itself.

Basically, the antenna functions as an  $\frac{1}{8}$  wave on 80,  $\frac{1}{4}$  wave on 40,  $\frac{1}{2}$  wave on 20, and  $\frac{3}{4}$  wave on 15, being base loaded on all except 20 meters where it is voltage-fed from the parallel resonant tank. The vertical radiator is made up of five six-foot lengths of  $\frac{1}{2}$ " diameter surplus whip. In the author's case, the whip is guyed with two sets of three guys each (light sash line, spring loaded at the lower ends to allow for shrinkage) at 12 and 24 foot levels. The antenna can be used at ground level (if well clear of buildings, trees, etc.) or well off the ground, using ground plane wires as an effective ground.

In the author's installation, the tuning unit is  $8\frac{1}{2}$  feet off the ground, at the same height as the aluminum patio roof. This roof, plus a heavy copper ribbon running to a good ground rod, makes up the "ground system."

The cold end of the coil is truly cold on all bands. The switches, S<sub>1</sub>, S<sub>2</sub>, and S<sub>3</sub> are actually heavy copper clips, although relays or knife switches could be used if available. The capacitor can be any variable type with a maximum capacity in the neighborhood of 100  $\mu$ fd. A National TMS-100 would be suitable.

Adjustment of the tuning unit was extremely simple. A grid dipper should be used in determining the proper setting for the S<sub>1</sub> tap, as well as getting the correct number of turns in the complete coil for resonance at 3.5 mc. The next step is to determine the correct feedpoint for the coax. If a SWR bridge is available, it amounts to finding the point which gives the lowest SWR on the feedline. If no bridge is available, the feedpoint can be found by observing reflected reactance in the final amplifier tank. With correct tap points at the antenna, the PA tuning will be very nearly the same with or without the feedline coupled to the transmitter.

Results have been excellent, considering the size of the system. The transmitter was free from TVI and no change was noted when switching to this vertical radiator.

As an example of its possibilities, only Europe is needed for a WAC on 3.5 mc. while running 450 watts input. It is hoped that this idea may be of some help to those amateurs living in so-called "impossible locations." -30-

Diagram of 4-band "Cliff-Dweller's" unit.

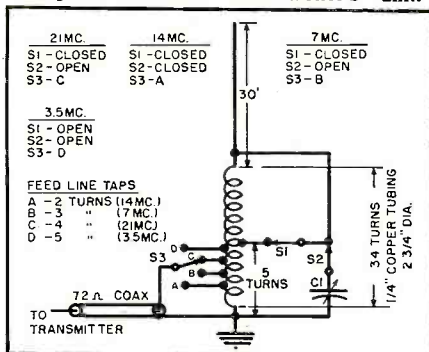

# Picking Winners...

You're always in luck when you use a Stephens System. These Tru-Sonic Speaker components are designed to mix and match with quality inbred across the board!

## Stephens Speaker Systems

### Your best low cost buy, 801

Low frequency driver is 15" 105LX, with a 2 $\frac{1}{2}$  lb. Alnico V magnet, 2" voice coil, large spider assembly and sturdy cast aluminum frame. System 801 has a 216 high frequency driver, 814H multicellular horn, and Stephens 800X-2 network and attenuator. Range is from 30 to 18,000 cps. 25 watts power capacity. Net \$165.00. For an excellent, three-way system, add a 214 super tweeter and 5000X crossover.



### Super two-way system 803

Uses two 103LX low frequency drivers, the finest available; a Stephens 216 high frequency driver releasing full 20 watts above 800 cps. Horn is the multicellular 824H, 2 cells high and 4 cells wide. System 803 utilizes 800X crossover and attenuator. Frequency range extends from 20 to 18,000 cps. 30 watts power capacity. Net \$269.25.

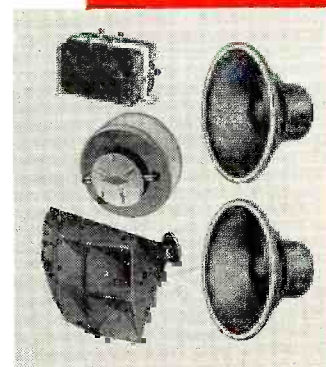

Note: This speaker system converts to a three-way system with the addition of a Stephens 214 super tweeter and 5000X network.

Hear the difference with Stephens.

For name of dealer nearest you, write:

# STEPHENS

TRU-SONIC

STEPHENS MANUFACTURING CORPORATION

8538 Warner Drive • Culver City, California

Cable Address "Morhanex" — Export Address: 458 Broadway, New York 13, N. Y.

## AUTO RADIO PARTS FORD-BENDIX, DELCO, COLONIAL

Pushbutton Radios For '55-'56 Ford, Chev, Plymouth  
Custom Mounting, 6 Tube, Net \$45.47  
Transistor Portable Radio—Complete  
With Battery—Net \$34.95

LYTRON DISTRIBUTING CO.

1338 W. North Ave. Baltimore 17, Md.

## NOW IN STOCK at ELMAR ELECTRONICS

140-11 Street Oakland 7, Calif.



COLOR & BLACK & WHITE

5" — 5 MC SCOPE

KIT \$79.95 Wired \$129.50



## DO-IT-YOURSELF!!!

### SPEAKER REPAIR PARTS & KITS

- Kit "A" REPLACEMENT CONE KIT... An assortment of popular sizes 4" to 12" including oval. Less voice coils. Kit of 12 assorted... \$1.98
- Kit "B" DE LUXE CONE KIT... same as above cones but containing larger variety of 20... \$2.98
- Kit "C" SPEAKER REPAIR KIT... Professional assortment of: RINGS, SPIDERS, VOICE COIL FORMS, CHAMOIS, LEATHER, FELT, SHIM KIT, CEMENT & INSTRUCTIONS... \$2.49

SPECIAL! Both Kits "A" & "C" \$3.95

- REPLACEMENT CONE & VOICE COIL ASSEMBLIES... FOR EVERY TYPE OF SPEAKER! (please specify OD, ID & depth)
- 4" or 5".....\$1.10 10".....\$2.50
- 6" or 4x6".....1.45 12".....3.00 up
- 5x7, 7", 8".....1.70 15".....4.50 up
- 6" x 9".....1.80

"Hi-Fi Speaker Repairs & Parts a Specialty" (Write for Free "Speaker Parts Manual")

- HI-IMPEDANCE HEADPHONES—2400 ohms DC. Adjust. forks; dble. rubber cord, DOUBLE \$2.49. SINGLE \$1.79.

LEOTONE RADIO CORP.  
65 DEY ST.  
NEW YORK 7, N. Y.



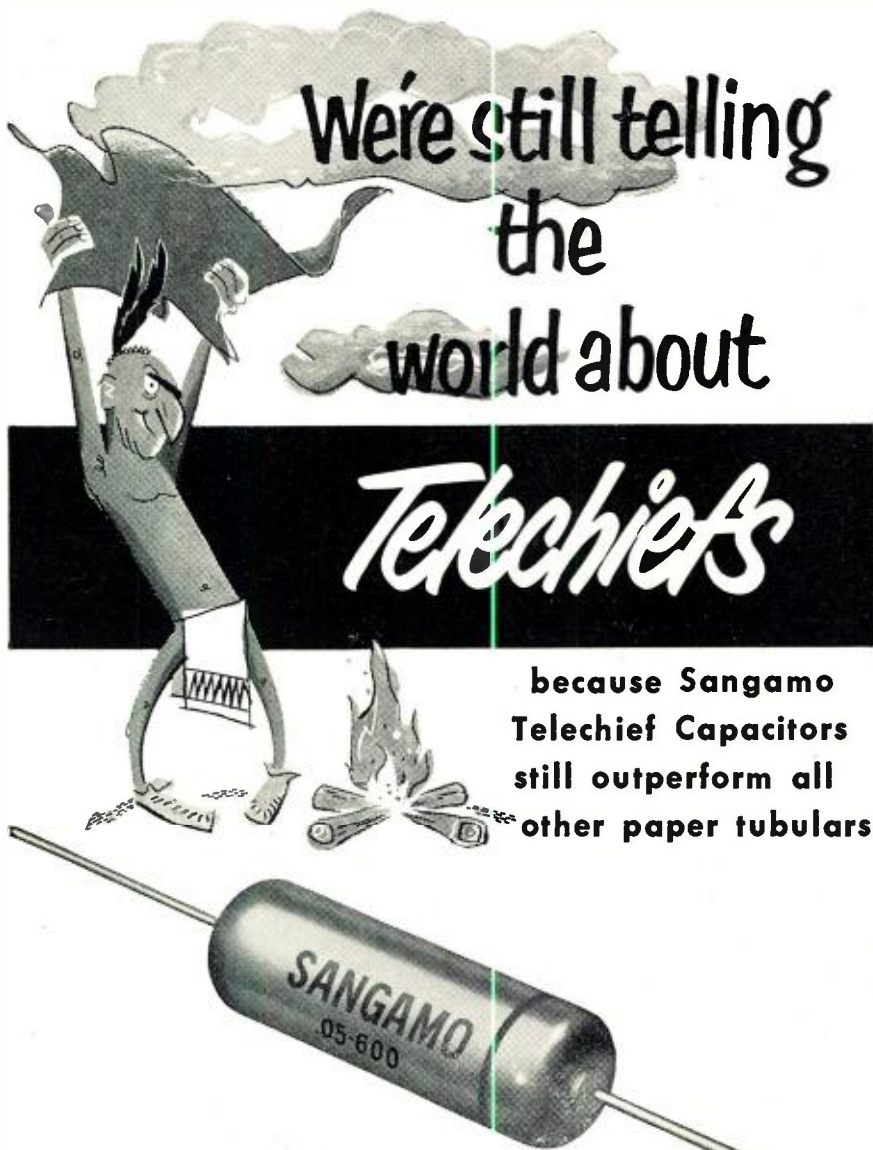

We're still telling  
the  
world about

*Telechiefs*

because Sangamo  
Telechief Capacitors  
still outperform all  
other paper tubulars

What do we mean when we say Sangamo Telechief Capacitors outperform all other molded paper tubulars?

Simply this: When it comes to moisture resistance... optimum operation in high temperatures... when it comes to holding rated capacity under all conditions, the Sangamo Telechief wins hands down.

Tests by major manufacturers and branches of the Armed Services—not our tests—have proven that Telechiefs outlive

all other molded tubular capacitors... that they have a final insulation resistance 10 to 15 times greater than any other paper tubular because they're molded in HUMIDITITE... the remarkable plastic molding compound developed by Sangamo.

HERE IS TRULY EXTRA VALUE AT NO EXTRA COST! Best of all, Telechief, the biggest value in molded paper tubulars, is available to you at the price of an ordinary capacitor.

SC55-9



SANGAMO ELECTRIC COMPANY  
MARION, ILLINOIS

## A Low-Cost Crystal Marker

By CHARLES H. WOOD, JR., K4CKO

*Build this handy ham shack  
unit for a buck and a half!*

**T**HIS crystal marker generator is a virtual "do-all" piece of equipment that the author has found indispensable in the ham shack. Even if you buy all new parts, this marker can be constructed for approximately one dollar and a half, excluding the crystal. A little later in the article a few of its many uses will be covered.

The circuit of this crystal marker is not critical. Any triode may be used or a pentode may be triode-connected and similarly used. The only changes that are necessary when using other than a 6J5 are the socket pin connections. The construction of this marker generator is straightforward in that lead length and placement are non-critical.

A power supply capable of delivering 6.3 volts at 0.3 amp. and 75 to 250 volts at 2 ma. is all that is needed. Any available power supply should easily handle these requirements.

It should be noted at this point that only fundamental type crystals are applicable in this circuit. Overtone type crystals should definitely not be used or damage to the crystal will result.

The uses of the crystal marker are limitless and after you have used this one for a while, you will agree that it was a very worthwhile addition to your equipment. This marker can be used as a spot frequency generator for servicing radios and television sets. For AM broadcast receivers, three crystals are needed: 456 kc., 600 kc., and 1400 kc. If you're working with color television, a 3.579 mc. crystal could be used. Similarly, crystals can be selected for alignment of FM and TV i.f.'s, etc.

Crystals may be selected for spotting the net frequency, spotting your

Schematic of the crystal marker unit.

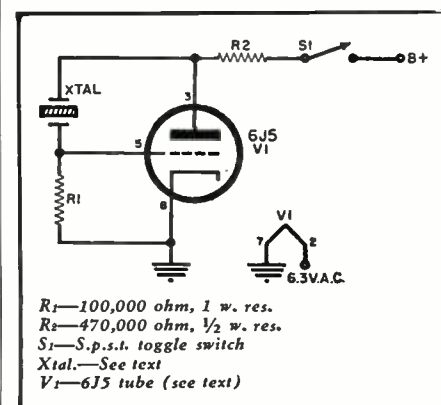



favorite short-wave station, or any other frequently-tuned-in frequency. If a 3.500 mc. crystal is chosen, this generator will mark the lower edge of the 80, 40, 20, and 10 meter amateur bands, insuring "within the band operation" if you like to operate near the lower edge of the band. It can even be used as a code practice oscillator with any receiver that incorporates a b.f.o. Just shunt the key across the "B-plus" switch, select a crystal within the tuning range of the receiver, and you're all set to go.

How about a receiver that you can instantly tune to Conelrad? Just install a crystal-controlled oscillator in your receiver, flip a switch, and you will be tuned precisely to 640 or 1240 kc. By picking a crystal one kilocycle higher or lower than the i.f. of your receiver, this marker may be used as a b.f.o. in receivers which do not already enjoy this feature, producing a 1000 cycle beat note. If you prefer a 2000 cycle beat note, choose a crystal which differs from the i.f. frequency by 2 kc. If you have a tunable converter, this generator will be handy for marking on your receiver the exact i.f. of your converter.

Many other ideas will suggest themselves once you have built this low-cost crystal marker.

-50-

### PHONE PLUG ADAPTER

BY ARTHUR TRAUFFER

IN THE course of some experiments, I wanted to connect a phone plug to a male mike chassis unit, but I had no adapter on hand and I didn't want to take time out to build one. I solved the problem by removing the spring on the end of a female mike connector. Then the phone plug was inserted into the connector so that the pointed bead on the end of the plug fitted into the eye in the center of the connector, then the set-screw in the connector was tightened to hold the assembly fast. The connector was then screwed onto the chassis unit, as shown in the photo. The result was a good solid connection that didn't give a bit of trouble!

This trick also gives pretty good shielding, as can be seen by studying the assembly, especially if you use a phone plug with a metal shell instead of the Bakelite one used by the writer. The set-screw in the female mike connector will not damage the phone plug if you don't tighten the screw too hard.

If your phone plug doesn't have a pointed bead, just be sure that the rounded bead centers in the eye in the connector. Then press the two units together tightly and tighten the set-screw in the connector.

-50-

One method for connecting a phone plug to a male mike chassis unit. Details in text.

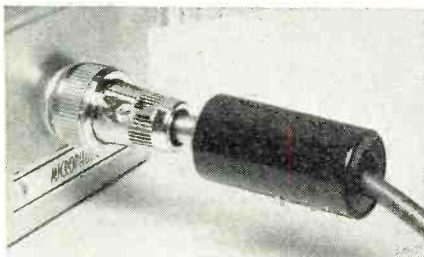

January, 1956

..but don't overlook

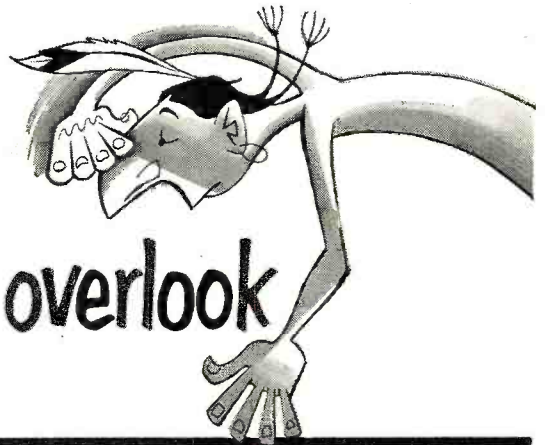

## SANGAMO REPLACEMENT ELECTROLYTIC CAPACITORS

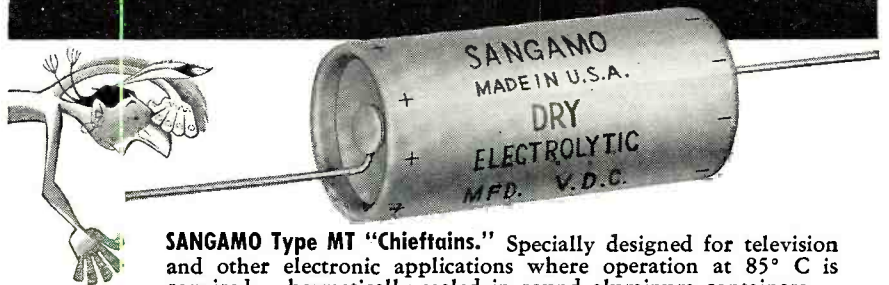

**SANGAMO Type MT "Chieftains."** Specially designed for television and other electronic applications where operation at 85° C is required... hermetically sealed in round aluminum containers... small size makes them good for mounting in limited space... they fit anywhere and can be mounted in almost any position.



**SANGAMO Type PL "Warrior."** These twist-tab electrolytics are used as original equipment by all major manufacturers... they are exact replacements... assure long life and dependable performance at 85° C and under conditions of high surge voltages and extreme ripple currents.



### SANGAMO Type CS "Tomahawk."

These electrolytic capacitors are contained in wax-filled cardboard tubes with insulated flexible leads approximately 8 inches in length extending from both ends of the unit. Each unit is supplied with a mounting strap to facilitate mounting to the chassis.

SC55-10

SANGAMO ELECTRIC COMPANY

MARION, ILLINOIS



123



# opportunities

AT  
**BELL TELEPHONE LABORATORIES**

A career for you with one of the nation's leaders in research and development in communications and military electronics.

**ELECTRONIC TECHNICIANS                      DRAFTSMEN**  
**ELECTROMECHANICAL TECHNICIANS**

Openings require previous training at high school, armed service school, or technical institute level and in general 2 or more years of applicable industrial or military experience.

Send your name and address for application, telephone collect within 100 miles for information, or visit us Monday through Friday. Evening interviews arranged.

**BELL TELEPHONE LABORATORIES**  
WHIPPANY, N. J. (Near Morristown)  
**WHIPPANY 8-1000                      EXTS. 2786, 300**  
**MURRAY HILL, N. J. (Near Summit)**  
**CRESTVIEW 3-6000                      EXTS. 3078, 3204**  
463 WEST STREET, NEW YORK CITY  
**CHELSEA 3-1000                      EXTS. 2871, 2873**

**FIDELIVOX**  
**RECORDED TAPES**  
THE LONGEST HOUR OF SOOTHING  
CATHEDRAL ORGAN BACKGROUND MUSIC  
Moderate Cost • Mail Order • Free Details  
ELECTROSONIC, 7230 Clinton, Upper Darby 4, Pa.

**WANT A BETTER JOB? BECOME AN ELECTRONIC ENGINEER**  
ONLY 32 MONTHS TO EARN A BACHELOR OF SCIENCE DEGREE IN ELECTRONIC ENGINEERING  
Class enrollment limited to allow for individual instructions. Chartered by state of California. Nonprofit, nonsectarian, coeducational—established 26 years.  
**APPROVED FOR VETS—ENROLL NOW!**  
SEND FOR FREE CATALOG  
**PACIFIC STATE UNIVERSITY**  
1516 S. WESTERN AVE.      LOS ANGELES, CALIF.

**Pulse Generator**  
(Continued from page 65)

the "Polarity" and "Power" switches in the author's model. If preferred, a volume control type switch could be used for the "Power" switch, permitting this unit to be combined with either the "Pulse Rate" or "Output" controls.

Although binding post output connectors were employed by the author, tip jacks, banana jacks, or even a coaxial connector may be used instead.

An Eveready type 411 battery may be used in place of the battery specified in the parts list. This unit is about the same size physically and supplies the same voltage as the battery used by the author.

Capacitor  $C_4$  is not critical, since it is used only for bypass purposes and a smaller or larger unit may be substituted here without difficulty.

The size of the output blocking capacitor,  $C_3$ , is non-critical, and either a larger or smaller capacity may be used here if desired. The larger capacities are suggested, however, to prevent possible distortion of the output signal waveform.

**Circuit Modifications**

The basic transistorized pulse generator may be easily modified to suit the specialized needs or requirements of the individual builder. Let us discuss the more important modifications in order:

*Changing Pulse Width:* As mentioned earlier, the pulse width depends primarily on the characteristics of the transformer used in the blocking oscillator circuit. The author used a standard "universal" audio output transformer in the model shown in the photographs. Where the prospective builder has access to special transformers, it should be practicable to substitute another unit to obtain either a narrower or a wider pulse.

*Changing the "Pulse Rate" Range:* The author's model covers a range from approximately 100 to 6000 pulses-per-second. Where a different range is desired, it is only necessary to change the value of  $C_1$ .

Using a larger capacity here will reduce the operating frequency, while a smaller capacity will increase the frequency. If desired, several "ranges" might easily be provided by using a selector switch to choose different values of  $C_1$ .

The pulse rate range covered by the "Pulse Rate" control may be extended to provide wider coverage or reduced to provide more accurate adjustment. To extend the range covered by the control, use a potentiometer having a larger maximum resistance (a 5 megohm or 10 megohm pot, for example). To reduce the range covered by the control, use a pot of lower maximum resistance (1 megohm, 500,000, or even a 100,000 ohm unit).

Where pulses at only a few fixed rep-

## LAMPKIN METERS

### + FCC LICENSE

### = HIGHER INCOME!

Over half a million mobile-radio installations need regular, high-grade maintenance and measurements per FCC regulations!

This means money . . . steady income . . . right in your own area.

**LAMPKIN 105-B MICROMETER FREQUENCY METER**

Measures numerous crystal-controlled transmitters, 0.1 to 500 mc. Gives error from assigned frequencies. VHF CW signal generator. Weight 13 lbs., width 13". \$220.00

**LAMPKIN 205-A FM MODULATION METER**

Reads peak FM voice deviation  $\pm 25$  kc., tunes 25-500 mc. in one band. Relative field-strength meter. Speaker. Jack for oscilloscope. Weight 13 lbs., width 12". \$240.00

**LAMPKIN METERS are the preferred test equipment!**

Send for new booklet . . . "HOW TO MAKE MONEY IN MOBILE-RADIO MAINTENANCE". No charge . . . just use coupon below.

**LAMPKIN LABORATORIES, INC.**  
MFM Division, Bradenton, Florida

At no obligation to me, please send

Free booklet       Data on Lampkin meters

Name \_\_\_\_\_

Address \_\_\_\_\_

City \_\_\_\_\_ State \_\_\_\_\_

**LAMPKIN LABORATORIES, INC.**  
BRADENTON, FLORIDA



etition rates are desired, a selector switch may be substituted for the "Pulse Rate" potentiometer, and fixed resistance values chosen as the switch is rotated.

**Changing the Output Impedance:** Where a lower or slightly higher output impedance is desired, it is only necessary to substitute a potentiometer of the desired impedance (resistance) for  $R_2$ . When this is done, care should be taken that the output transistor cannot be accidentally overloaded. Do not use a pot of less than 3000 ohms with a 15-volt supply.

**Obtaining Pulses of Fixed Amplitude:** Where the user will not need an adjustable output amplitude, a fixed resistor may well be substituted for  $R_2$ . The output pulse amplitude should approximate the battery supply voltage and should remain fairly constant, even at different repetition rates.

A fixed amplitude signal with a lower value may be obtained by using two fixed resistors in series in place of  $R_2$  to form a simple voltage divider. The output signal is obtained at the junction of the two resistors.

**Obtaining Pulses of Fixed Polarity:** Should the user not require both positive- and negative-going pulses, the pulse "Polarity" switch may well be omitted and the circuit permanently wired to deliver whichever type of signal the user requires.

The possible applications of a pulse generator are too numerous to more than briefly indicate. New applications

are constantly being worked out, and the individual worker often finds that the only limitation on his use of the instrument is his ingenuity and skill in applying it.

The pulse generator is particularly valuable for operating many types of "slave" sweep circuits or for syncing "recurrent" sweeps and multivibrators.

A simple linear sweep (saw-tooth signal) generator may be formed by using the positive-going pulse from a pulse generator to operate a "discharge" tube connected across the capacitor in a simple RC series network. The capacitor is charged slowly through the resistor from a d.c. source, then discharged rapidly by the tube when a positive pulse is applied to its grid.

Pulse generators are widely used for checking and testing delay lines, for checking the transient response of amplifiers, for testing counter circuits, and for calibrating and testing radiation instruments.

The pulse signals obtained from a pulse generator are also useful for oscilloscope retrace blanking and for use as a "marker" to divide a scope trace into segments of known duration. In both of these applications, the pulse signal is applied to the "Z-Axis" or "Intensity Modulation" terminal of the scope.

Considering the small amount of time and money required to build this compact unit, it makes a worthwhile project.

**ONE Generator covers 150 kc—435 mc!  
WORLD'S BEST GENERATOR BUY!**



**New! EICO SIGNAL GENERATOR #324  
KIT \$26.95      Wired \$39.95**

- 6 fundamental bands: 150-400 kc, 400-1200 kc, 1.2-3.5 mc, 3.5-11 mc, 11-37 mc, 37-145 mc, 1 harmonic band 111-435 mc. Covers AM, FM, TV, & Amateur freqs.
- $\pm 1.5\%$  frequency accuracy; 6:1 vernier tuning knob & excellent spread at most important alignment frequencies.
- Etched tuning dial, plexiglass windows, edge-lit hairlines.
- Variable depth of int. mod. 0-50% by 400 cps Colpitts osc.
- Variable gain ext. mod. ampl.; only 3.0 v for 30% mod.
- Colpitts RF oscillator plate-modulated by cathode follower.
- Turret-mounted, slug-tuned coils.
- Fine & Coarse (3-step) RF attenuators; 50-ohm output Z.
- RF output 100,000 uv; AF output to 10 v.

In stock at local parts distributors coast to coast.  
Write for free Catalog RG 1

**EICO**®

Prices 5% higher  
on West Coast

84 Withers Street • Brooklyn 11, N.Y.

© 55

★ NO FREE GIFTS! NO COUPONS! NO BONUSES EXCEPT THE

# ★ ★ ★ LOWEST TUBE PRICES

**ALL TUBES UNCONDITIONALLY GUARANTEED FOR 1 YEAR**

Pretested Tubes		Individually Boxed	
1B3GT	6AC7	6BK5	6SK7GT
1H5GT	6AG5	6BK7	6SL7GT
1LC5	6AG7	6BL7GT	6SN7GT
1LN5	6AF4	6BQ6GT	6SQ7
1N5GT	6AK5	6BQ7	6SR7
1Q5GT	6AL5	6BY5G	6T8
1R5	6AQ5	6BZ7	6U8
1S4	6AS5	6C4	6V3
1S5	6AT6	6CB6	6V6GT
1T4	6AU6	6CD6G	6W4GT
1T5GT	6AU5GT	6F6	6W6GT
1U4	6AV5	6H6GT	6X4
1U5	6AV6	6J5GT	6X5GT
1X2	6AX4GT	6J6	6Y6G
3Q4	6AX5GT	6K6GT	7C5
3S4	6AH4GT	6L6	7C6
3V4	6BA6	6S4	7E7
SU4G	6BC5	6S8GT	7F7
5V4G	6BE6	6SA7	7F8
5Y3	6BG6G	6SH7	7N7
6AB4	6BJ6	6SJ7GT	12AL5
			12AT7
			12AU6
			12AU7
			12AV6
			12AV7
			12AX4GT
			12AX7
			12BA6
			12BE6
			12AZ7
			12BH7
			12BZ7
			12BY7
			12SA7
			12SG7
			12SJ7GT
			12SK7
			12SL7GT
			12SN7GT
			12SQ7
			12SR7
			19T8
			19BG6G
			19BQ6GT
			25L6GT
			25AV5
			25W4GT
			25Z5
			25Z6GT
			35B5
			35C5
			35L6GT
			35W4
			35Y4
			35Z5GT
			50A5
			50B5
			50C5
			50L6GT
			117L7GT
			117Z3

**BRAND NEW PICTURE TUBES—RCA and DUMONT Licensed**

12LP4	\$14.99	17BP4A	\$19.00	20CP4	\$24.00
14BP4	15.99	17HP4	19.00	21ALP4A	24.00
16AP4A	19.99	17LP4	18.00	21EP4A	24.00
16GP4	20.99	19AP4A	23.00	21AUP4A	24.00
16RP4	17.00	19DP4A	23.00	21FP4	24.00
				24AP4	42.00

Picture Tubes Shipped F.O.B. Passaic, N. J.

# TUBE MART DISCOUNT HOUSE

The Lokpet Bldg. Passaic, N. J.

Take your pick!  
Any Assortment!

# TUBES 41¢ ea.

Quantity Buyers!

100 Tubes — \$38.00

**FREE POSTAGE**

On all prepaid U.S.A. orders. 25¢ handling charge on all orders under \$5.00. 25% Deposit on all C.O.D.'s. Subject to prior sale.

Write for

**FREE TUBE LIST!**



Your choice of school  
is highly important  
to your career in



**INDUSTRIAL  
ELECTRONICS**



**RADIO**



**TELEVISION**

Become an  
**ELECTRICAL  
ENGINEER**

or an

**ENGINEERING  
TECHNICIAN**

at

**MSOE in Milwaukee**

Choose from courses in:

**ELECTRICAL ENGINEERING**  
Bachelor of Science degree in 36 to 42  
months with a major in electronics or  
electrical power.

**ELECTRICAL TECHNOLOGY**  
Engineering Technician certificate  
in 12 months in electronics, radio, or  
electrical power.

Associate in Applied Science degree  
in 18 months in radio and television.

**TECHNICAL SERVICE**

Service certificate in 6 months in electric-  
ity; in 12 months in radio and television.

**MSOE** — located in Milwaukee,  
one of America's largest indus-  
trial centers — is a national  
leader in electronics instruction  
— with complete facilities,  
including the latest laboratory  
equipment, visual aid theater,  
amateur radio transmitter —  
offers 93 subjects in electrical  
engineering, electronics, radio,  
television, electrical power,  
and electricity.

Advisory committee of lead-  
ing industrialists. Courses  
approved for veterans. Over  
50,000 former students.

Excellent placement record.

TERMS OPEN APRIL, JULY,  
SEPTEMBER, JANUARY

Choose wisely — your  
future depends on it. Write  
for more information today!



**MILWAUKEE**

**SCHOOL OF ENGINEERING**

Dept. RN-156, 1025 N. Milwaukee St.  
Milwaukee 1, Wisconsin

Send FREE career booklets on:

Electrical Engineering  Radio-Television

I am interested in.....  
(Name of course)

Name.....

Address.....

City..... Zone..... State.....

If veteran, give discharge date.....

MS-31

**Spot Radio News**  
(Continued from page 18)

shelters are constructed of aluminum  
sheeting and insulated with a foamed-  
in-place plastic. Included among the  
equipment are a control tower unit,  
a low-frequency beacon, a direction-  
finder, radio receiver and transmitter,  
facsimile apparatus for weather re-  
ports, and a complete mobile elec-  
tronics shop for maintenance work.

The most important element in the  
system is the control tower. During  
transport, the glass-walled astrodome  
of the control tower telescopes into  
the control tower housing, but can be  
elevated during operation for com-  
plete visibility. Since the tower op-  
erator is confined to a relatively small  
area for long periods, the equipment  
has been planned for his comfort. Meteorological instruments are in  
plain view; there is adequate lighting  
and the tower has been air-conditioned  
for both tropical and arctic climates.

When the control tower is in opera-  
tion, it can be used to assist in land-  
ing aircraft carrying the remainder of  
the communications-navigation gear,  
or begin the task of directing other  
aircraft to take off or land at the for-  
ward airstrip.

With a homing beacon and a direc-  
tion-finding unit to aid landings of  
lost or strayed aircraft, and with the  
necessary transmitters and receivers,  
the new system was described as a  
near duplicate of any permanent air  
traffic control system.

**ALTHOUGH ELECTRONIC BUILD-  
ING** blocks have become widely ac-  
cepted for their general function and  
circuit arrangement, no attempt has  
been made by industry to standardize  
their exact circuit configurations or  
the resistance or capacitance values  
of their components. Everyone has  
recognized that one of the great ad-  
vantages of electronic techniques is  
the flexibility of the circuits, both  
during design and production, since an  
electronic assembly consists of many  
parts that may be rather easily re-  
placed by others. Electronic engi-  
neers have been naturally reluctant  
to surrender this flexibility except for  
great compensating advantages.

It has been found, though, that  
standardization of circuits used in  
aeronautical electronic equipment  
could result in worthwhile advantages  
to both the military user and the in-  
dustrial producer.

For example, most aeronautical  
electronic equipment includes rectifier  
circuits, and many include amplifier,  
timing and other circuits. Some of  
the circuits in a complete piece of  
equipment are unique and especially  
designed for that particular equip-  
ment, but the majority of circuits in  
any device are of widely-used types.

To the military, standardization  
means lower purchase prices, shorter  
delivery time, greater operating re-  
liability, fewer spare parts at field in-  
stallations, and simpler maintenance  
procedures. For the producers, there  
is the prospect of economies in design  
and production engineering. Junior  
engineers, usually assigned the routine  
work of designing or selecting such  
well-known circuits, would have their  
work facilitated and this, in turn,  
would reduce the supervisory burdens  
of the senior engineers. Production  
would benefit from fewer designs and  
reduced inventories.

Several years ago, the Navy Bureau  
of Aeronautics and the Bureau of  
Standards decided to undertake a  
study of a plan that would result in  
a circuit standardization program. To  
initiate the investigation, experts  
made a detailed examination of twen-  
ty-two pieces of aeronautical-elec-  
tronic equipment including radar sets,  
indicator assemblies, radios, and sim-  
ilar gear. Sources of information in-  
cluded instruction manuals, specifica-  
tions, and the experience and advice  
of equipment engineers and mainte-  
nance personnel. The over-all circuits  
were divided into functional subcir-  
cuits and then subjected to systematic  
analysis of the detailed circuit differ-  
ences and of design parameters. Con-  
siderable attention was paid to the  
establishment of common termi-  
nology, as different equipment design-  
ers may use widely different names  
for essentially the same circuit.

The results showed that the over-all  
circuits of the twenty-two equip-  
ments were essentially made up of  
sixty circuit types. Although the cir-  
cuits falling within a given type were

**NEW TV STATIONS ON THE AIR**

(As of December 25, 1955)

The following new stations bring the lists published in previous issues up to date.

STATE, CITY	STATION	CHANNEL	FREQUENCY RANGE (IN MC.)	VIDEO WAVELENGTH (IN FT.)	VIDEO POWER (IN KW.)
Arkansas El Dorado	KRBB	10	192-198	5.08	24
South Dakota Florence	KDLO-TV	3	60-66	16.06	27
Texas Big Spring	KBST-TV	4	66-72	14.61	12.75
Laredo	KHAD-TV	8	180-186	5.43	2.27
Territories Wailuku, Hawaii	KMVI-TV	12	204-210	4.79	30
Canadian Stations North Bay, Ont.	CKGN-TV	10	192-198	5.08	51.5
Mexico Nuevo Laredo	XEFE-TV	11	198-204	4.93	

The frequency of the video carrier = 1.25 + channel lower freq. limit. Total number of  
TV stations now on the air in U.S.: 473 (116 of which are u. h. f.).



not identical, in many cases examination showed that these circuits were sufficiently similar in their more important aspects so that standardization would be feasible. For example, it was found that certain range marker generator circuits could be identical for many of the radars and for other time-scale indicators.

Even the various elements in tubes were considered. To illustrate, it has become the practice to use the ratio of the number of cathodes in standardizable portions of the circuit to the number of cathodes in the over-all circuit. Cathodes are counted instead of entire vacuum tubes to avoid ambiguity resulting from such items as double triodes. On this basis, the feasibility study showed that 50 to 75% of the cathodes were standardizable.

It was found that the most promising field of standardization was in the power supply circuits. One of the first steps that became evident here was the reduction possible in the number of power-supply voltages. It was found that the voltages used in the twenty items under study showed twenty different nominal values, which appeared readily reducible to four.

As a result of the favorable outcome of the feasibility study, work was started on a preferred circuits program. Priority was given to the most widely used and readily standardizable items. The work on any given circuit required both theoretical and experimental studies of the known versions, so that a *least-common denominator* circuit could be established. Thus far a number of standardizable

factors have been well established.

The investigation, which is now in high gear, is expected to result in major economies in critical engineering man hours, lead time, and by accelerating production. It should also provide the military with means for simplifying maintenance training, designing simple *throw-away* units, achieving improved operational reliability, and establishing design standard levels.

The engineering electronics laboratories of the Bureau of Standards, directly involved in the standards study, is cooperating with industrial groups engaged in similar programs.

**THE CAREFULLY-DEVELOPED MIL-LION-DOLLAR CONELRAD** plan, adopted by nearly 1300 commercial

## FM TRANSMITTER

27 to 38.9 MC

BC-924—TRANSMITTER: Four preselected Channels, M.O. Control, 30 Watt slug tuned Coils, high & Low Switch. Uses 2/815 tubes, 2/6S17, 1/6SL7, 1/6V6, 1/6A6, 1/6V8, 1/6V150. Voltage required 12 or 24 V. and 400 MA. @ 400 MA. Size: 11" x 11" x 11". With Schematic.....NEW: **\$24.95**

## TOWER and ANTENNA EQUIPMENT

TRYLON TOWER—Triangle Galvanized Steel Tower—12 1/2" Base, 30 Ft. High—in 10 Ft. Sections. (Two Towers may be put together for 60 Ft.) Knocked down—Complete with Hardware, two 50 Ft. and one 80 Ft. Guys, three 5 Ft. Anchors, and Base Plate. Each section weighs 45 lbs. Complete with Erection Manual. Shipping Weight: Approx. 350 lbs. F.O.B. Ky. Price..... **\$31.95**

### MAST BASES—INSULATED:

MP-22 BASE—(Illustrated) Ins. spring action; direction of bracket can be raised or lowered easily..... **\$2.95**

MP-S-33 BASE—Insulated type with heavy coil spring and 5" dia. Ins. Requires 2" hole for mounting. Weight: 9 lbs..... **\$5.95**

MP-48 BASE—Insulated type base with heavy coil spring. Requires 1 3/8" mounting hole. Weight: 11 lbs..... **\$4.95**



### MAST SECTIONS FOR ABOVE BASES:

Tubular steel, copper coated, painted in 3 ft. sections, screw-in type. MS-33 can be used to make any length with MS-52-51-50-49 for taper. Any section.....@ 50¢ Each  
Larger Diameter Section: MS-54.....75¢

**ALL ITEMS PREVIOUSLY ADVERTISED STILL AVAILABLE—SEND FOR LIST!**

### CLASSIFIED ITEMS:

BC-212G Amplifier—2/6C5 tubes.....NEW: \$ 1.95  
BC-216 Amplifier—6F7 & 39/44.....USED: 1.50  
BC-229/429 Receiver—2500-7700 KC w/Coils U: 6.95  
BC-230 Transmitter—2500-7700 KC w/Coils. U: 8.95  
BC-347 Amplifier—1/6F8G tube.....N: \$3.95; U: 1.95  
BC-357 Marker Beacon Rec.—75 MC.....N: \$1.95; U: 2.95  
BC-367 Amplifier—2/6V6 tubes.....N: \$1.95; U: 2.95  
BC-375 Transmitter.....Used: 29.95  
BC-442 Antenna Relay Box—w/Cond.....New: 2.95  
BC-500 Trans. & Receiver—25 Watt, 20-28 MC. 59.50  
BC-604 Transmitter—20 to 28 MC.....Used: 9.95  
SCR-625 Mine Detector—Recognized.....49.95  
BC-654 Transceiver—3800 to 5800 KC.....Used: 34.95  
BC-709 Amplifier—Batt. Operated.....New: 1.95  
BC-745 Transceiver—3 to 6 MC.....Used: 14.95  
BC-966 1FF—160 to 211 MC. 13 tubes.....Used: 5.95  
BC-1206 Receiver—200 to 400 Kc.....New: 9.95  
RT/ARR-I Receiver—Converts to 2 or 6 Meters 2.95  
RT-7/APN-I Altimeter—440 MC.....Used: 9.95  
RT-34/APS-13 Transceiver, Complete, less tubes U: 3.95  
Range Beam Filter, Navy Type \$1.95; FL-8 Used: 1.49  
EE-8 Field Telephones—Checked.....Used: 14.95  
RM-21 Radio-Telephone—Remote Control. Used: 19.95  
BD-72 Portable 12 Line Switchboard.....Used: 39.95  
Sound Powered Head & Chest Set—Checked.... 3.95  
T-17 Microphone—Clean, Used, Checked..... 3.95  
HS-30 Headset—Hearing Aid Type—L.N..... 1.50  
CD-874 Cord—f/HS-30—Low Imp., w/PL-55.U: .59  
CD-605 Cord—f/HS-30—High Imp., w/PL-55.N: .79  
CD-307 Cord—w/PL-55 & JK-26..... .59  
CD-318 Cord—2/PL-68, JK-48, & SW-141.....U: .89

## TRANSMITTER & MODULATOR

67 to 74 MC

BC-463—20 Watt, Crystal Control—Complete with 16 Tubes: 1/815, 1/12J5, 2/12SN7, 2/6V6, 2/6L6, & 1/VR-150. Also Output Meter, Crystal Modulator Trans., Motor, & Fan.....USED: **\$16.95**

## HIGH FREQUENCY RECEIVER

R-74/CRW-2 RECEIVER—53 to 88 MC—For remotely controlled radio systems on preselected freq. Complete with tubes & 24 Volt Dyn. Size: 9 1/2" x 8" x 4 1/2".....NEW: **\$9.95**

## TG-34A KEYS

TG-34A KEYS—115 or 230 Volts at 50 to 60 cycles—an automatic unit for reproducing audible code practice signals previously recorded in ink on paper tapes. By use of the self contained speaker, the unit will provide code practice signals to one or more persons—or provide a keying oscillator for use with a hand key. Unit is compact & portable carrying case, and complete with Tubes, Photo Cell and Operating Manual. Size: 10 1/2" x 10 1/2" x 15 1/2". Shipping Weight: **\$16.95**  
45 lbs.....NEW: **\$16.95**

TG-10 KEYS—Same function as TG-34A—only larger—using 2/6N7—2/6L6—2/6S17—1/5U4G Tubes and 1/923 Photo Cell. Housed in standard Metal Cabinet, with provision for 19" rack mtg. Size: 11" H x 24" W x 18 1/2" D. Price—USED, TESTED.....Only **\$14.95**

## BLANK PAPER TAPES FOR CODE RECORDERS:

3/8" Wide, in 90 Ft. Rolls—Prices: 25¢ Each—or 6 Rolls f/\$1.00—30 Rolls f/\$3.00—60 Rolls f/\$5.00

## NOVICE BAND TRANSMITTER

### TRANSMITTER AND AUTOMATIC KEYS

T-121—3.5 to 4 MC; 50 Watt Crystal Control (Crystal in Novice Band) MO. P.A. for CW. W/2/1625, 1/25L6 Tubes & Crystal Keyer consists of 24 VDC Keyer Assy & Code-Wheels. Size: 8 1/2" x 6 3/4" x 9 1/2". w/Innovated for instruction Book. NEW: **\$7.95**

## TRANSFORMERS—115 V. 60 CYCLE PRI.:

600 VCT/100 MA—6.3 V/5 A; 5 V/3 A.....\$4.95  
350 VCT/40 MA—3.3 V/2.4 A; 6.3 V/1.6 (Rect. 6 x 5) 1.75  
1500 VCT/350 MA—Tapped at 600.....9.95  
1300 VCT/350 MA—5 inches Sq.....6.95  
940 VCT/500 MA—6" x 5" x 5".....5.95  
700 VCT/150 MA—5 V/3 A; 6.3 V/4.5 A. CSD.....3.95  
2500 V/015 A; 2.5 V/175 A; 6.3 V/4.5 A.....5.95  
1890 V/12.6 MA—Tapped 2.5 V 2 A.....5.95  
1100 V/80 MA—7.5 VCT/3.25 A.....5.95  
9 Volt CT—35 Amp.—Tapped 4.5 V.....7.95  
12 Volt—Two separate windings—4 amp each.....5.95  
28 Volt 8 Amp—Tapped 4 Volt.....5.95  
5 V/2 A; 5 V/2 A; 5 V/2 A; & 5 V/6 A.....2.95  
600-0-600 VAC—200 MA. 12.5 V. 2 A.; 12.5 V. @ 2 A.; 5 V. @ 3 A.—#H-108—Price.....8.95  
250-0-250 VAC—50 MA. 24 V. 1 A.; and 6.3 V. 1 A.—#H-109—Price.....4.95

CURRENT TRANSFORMER—Ratio 150 to 5; 25 to 60 cycle. Wes. Style 81R691.....\$ 8.95  
CONSTANT VOLTAGE REGULATOR—115 Volt 60 cycle, 80 VA. Sola #30726.....12.95

Choke—12.5 Hy/10 MA.....\$1.95  
Choke—5 Hy/200 MA—80 Ohm.....1.25  
Choke—8 Hy/150 MA—200 Ohm—Open Frame.....1.25  
Choke—5 Hy/150 MA—85 Ohm.....1.50

## PANORAMIC ADAPTER And OSCILLOSCOPE

ID-60/APA-10—Two units in one Panadapter & Scope with three inputs for feeding IF Freq. of 455 KC, 5.2 MC, or 30 MC from receivers for viewing on 3" scope tube. Can also be used as regular scope; has vertical and horizontal push pull Amplifier inputs. Complete with 21 Tubes. Operates from 115 V. 400 cycle.....New **\$49.50**

## BROADCAST RECEIVER

NAVY TYPE—520-1500 KC. NEW.....\$19.95  
LIKE NEW.....\$14.95  
Q 5 er. NAVY TYPE—190-550 KC.....NEW: \$12.95  
R-28/ARC-5 REC.—100-156 MC. w/Tubes.....\$10.95  
NAVY TYPE COMM. TRANS.—2-1-3 MC. NEW: \$7.95.....USED: \$5.95  
NAVY TYPE COMM. TRANS.—3-4 MC. USED: \$12.95  
BC-458 TRANS.—5-3.7 MC. NEW: \$5.95—USED: \$3.95  
Navy Type Trans.—7-9 MC.....New: \$7.95—Used: \$5.95  
BC-1206—200 to 400 KC.....\$9.95

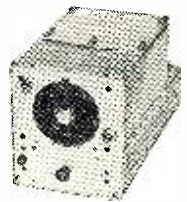

## DYNAMOTORS:

### HEAVY DUTY MOBILE DYNAMOTOR:

DM-42—14 V. input; output 1030 VDC—260 MA. & 515 V. 215 MA. @ 6 VDC. Approx. half of Voltage.....NEW: \$9.95—USED: \$4.95

INPUT VOLTS:	OUTPUT VOLTS:	MA.	STOCK No.	PRICES: USED:	NEW:
12 VDC	220	80	DM-34	\$2.95	\$ 4.95
12	625	225	DM-35	3.95	12.95
12	230	90	PE-133	4.95	6.95
12 or 24	230	100	DA-12		8.95
12 or 24	540	450	DA-14		14.95
12 or 24	500	50	USA/0515		4.95
12 or 24	275	110	USA/0516		4.95
14	375	150	BD-82	3.95	4.95
14 VDC	330	150	BD-87	3.95	5.95
14	250	50	DM-25	6.95	8.95
14	1000	350	BD-77	14.95	29.95
24	250	60	PE-86		8.95
28	1000	350	PE-73		8.95

## METERS:

### WESTON AC AMMETER:

(Pictured) In portable leather case, with Test Leads, 2 1/2", 0-15 AC and 0-3 AC Scale..... **\$5.95**



DC AMMETER HOYT: In portable metal case, with Test Leads, 4 1/2", Fan Mirrored Scale 0-15 ADC.....\$4.95

**NEW ITEM** DB METER—10 to +6 Westinghouse 2" NC-35 Imp., 600 ohms @ 1000 cycle \$1.95

0-3 RF AMMETER IS-128: 2 1/2" Rd.....NEW: 2.95  
0-8 Amp RF w/Thermocouple IS-89: 2 1/2" Rd... 4.95  
0-15 AC-DC—2 1/2" Rd.; IS-122..... 4.95  
0-500 MA DC—2 1/2" Rd.; IS-22..... 4.95  
0-2 MA DC Westinghouse; 3/2" Rd..... 2.95  
0-20 MA DC Westinghouse; 3/2" Rd..... 2.95  
0-150 V. 60 cycle; Simpson; 3/2" Rd..... 3.95  
0-250 MA DC—0eJur, 3" Sq..... 3.95  
OUTPUT—5 Ranges, 4000 Ohm Imp.—Used..... 4.95

**FAIR RADIO SALES**

132 SOUTH MAIN ST. LIMA, OHIO

Address Dept. RN • \$5.00 Order Minimum, & 25% Deposit on C.O.D.'s. • Prices are F.O.B., Lima, Ohio



# NOW...

you can replace your ordinary cartridge with a



regardless of the make or model of your record player

The unanimous editorial acclaim by the critics plus the public enthusiasm over the amazing performance of Ronette Fonofluid Cartridges has resulted in a sudden demand for these cartridges.

Today there is a Ronette Fonofluid Cartridge . . . already famous for its high compliance, low intermodulation distortion and full frequency response . . . available in high or low output — turn-over or single needle model . . . in a variety of mountings and brackets designed for replacement in every record player ever manufactured.

Hear all the music you are paying for . . . use a

Ronette

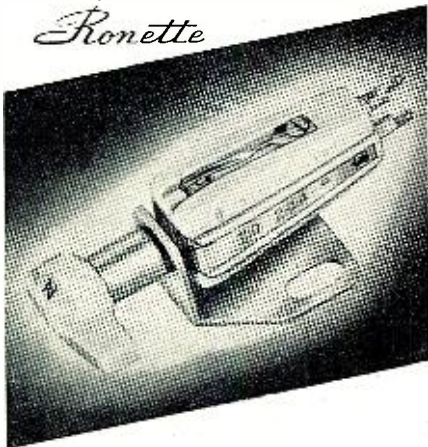

Model TO-284P (Illustrated): with 2 non-interacting sapphire needles.....\$7.50 net  
Other models .....from 5.40 net

Diamond needles available at extra cost.

RONETTE ACOUSTICAL CORP.  
135 Front Street, New York 5, N. Y.

Please send literature describing in detail the entire line of Ronette Fonofluid Cartridges and other Ronette audio components.

Name.....

Address.....

City.....Zone.....State.....

broadcasters to shift to 640 or 1240 kc. in an air-raid target area and subsequent intermittent transmission, has run into civil defense trouble in California.

The state's CD director has taken the whole warning plan to task and tagged it obsolete and a . . . "highly dangerous panic-producing potential . . ." because too much time is consumed before the plan begins to function, and in addition the cluster signals fade and do not cover sufficient distances reliably.

The technique developed for cluster broadcasting, as a means of circumventing the use of standard broadcast signals for homing by alien aircraft, was described as unsound.

It was charged that the . . . "concept of a potential enemy's dependence upon our commercial broadcast stations for navigational purposes is, in itself, exaggerated, unrealistic and outmoded."

In defense of the warning system, a FCC expert said that Conelrad is basically a counter measure against enemy planes who might use broadcast signals for guidance. This, it was said, was still a key factor and would become more so with the stepped-up use of guided missiles. It was agreed that a warm-up-time situation did exist but this was called minor because some stations could shift from normal to emergency operations in about five minutes. Probably the most difficult problem to overcome is the twenty-five mile transmission limit of the cluster stations; under present evacuation plans, those sent outside of the city limits would be deprived of over-the-air information.

**NOTWITHSTANDING THE SQUABBLE** over u.h.f. effectiveness, some still have faith in the band and are buying expensive transmitting equipment.

Recently WGBI-TV, Scranton, Pa., purchased a 45-kilowatt transmitter and a 50-gain helical antenna combination that will provide an output of 2 megawatts, and also feed signals to two associate stations in Williamsport (WRAK-TV) and Sunbury (WKOK-TV). These allied telecasters dug into their bank balance and bought 1 and 12 kw. stations and 25-gain antennas. The channels involved are 22, 36, and 38.

Station-grant activity was also a bit livelier during the early winter months, and produced approvals for some high and low-band stations as noted on page 16 of this issue.

**THE FATHER OF INFORMATION THEORY**, Claude E. Shannon, was honored recently at the *Franklin Institute* with the Stuart Ballantine medal award for his outstanding contributions, which have made it possible to establish an index that accurately describes the size and complexity of communication facilities required to handle messages; a major concept that has revolutionized transmission and reception design and application techniques. . . . L. W.



## A COMPLETE \$159<sup>50</sup> HI-FI SYSTEM

AMPLIFIER • SPEAKER • RECORD CHANGER

FOR ONLY

# \$99<sup>50</sup>

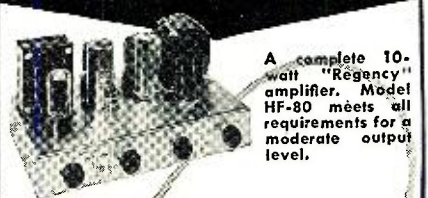

A complete 10-watt "Regency" amplifier, Model HF-80 meets all requirements for a moderate output level.

Royal "Monarch" 3-speed record changer, Model RP5 with "turn-over cartridge. Made in England. Plays all 7, 10 and 12 inch records intermixed—absolutely jam proof.

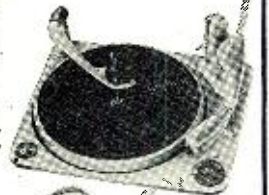

Nationally famous "Universality" extended range speaker, Model 6200. Full body response to beyond 10,000 cycles.

## Almo RADIO CO.

509 ARCH ST., PHILA.

BRANCHES: Camden, N. J. • Atlantic City, N. J.  
Norristown, Pa. • Wilmington, Del. • Salisbury, Md.  
Export orders promptly filled—cable address "ALRAD"

When Answering Advertisements  
Please Be Sure to Mention  
**RADIO & TELEVISION NEWS**

## TELEVISION

**PREPARE FOR A GOOD JOB!**  
BROADCAST ENGINEER  
ELECTRONICS RADIO SERVICING

**Television Servicing**

(Approved for Veterans)  
SEND FOR FREE LITERATURE  
**BALTIMORE TECHNICAL INSTITUTE**  
1425 EUTAW PLACE, BALT. 17, MD.

**RADIO & TELEVISION NEWS**



# A Method of Measuring High Resistance

By **J. P. C. McMATH**  
Assoc. Prof., Electrical Engr.  
University of Manitoba, Winnipeg

A simple technique which requires no special, hard to get test instruments.

THE writer has found the following method of measuring high resistances most useful. It is particularly advantageous for measuring the insulation resistance of capacitors and the interelement leakage in vacuum tubes. It is capable of a sensitivity and accuracy otherwise attainable only by the use of expensive special-purpose measuring equipment which is seldom available to the amateur. Any desired test voltage, of either polarity, may be applied.

The basic principle, the so-called series voltmeter method, is given in many textbooks but does not appear to be in very general use. To apply the method, the resistance to be measured is connected in series with a vacuum-tube voltmeter having a known input resistance, as indicated in the diagram. A suitable known direct voltage is applied to the series circuit. Solution of this simple circuit gives:

$$R_x = [(E/e) - 1]R_v$$

An example will illustrate the sensitivity of the method. Suppose  $E$  to be 300 volts (a reasonable value for testing most ordinary capacitors), the vacuum-tube voltmeter to have an input resistance of 11 megohms (a common value, including the usual 1-megohm isolating resistor in the probe) and a 1-volt full-scale sensitivity on its most sensitive range. Then, for full-scale deflection on the 1-volt range, we would have  $R_x = [(300/1) - 1]11 = 3289$  or approximately 3300 megohms, measurable essentially to the accuracy of the vacuum-tube voltmeter. If we are merely interested in detecting rather than measuring leakage, we can readily detect 0.1 volt or less on the 1 volt range, thus making the "reasonably detectable" limit in our example 33,000 megohms.

If instead of a vacuum-tube voltmeter (which normally has constant input resistance on all ranges) an ordi-

Method of applying high resistance measurement technique described in article.

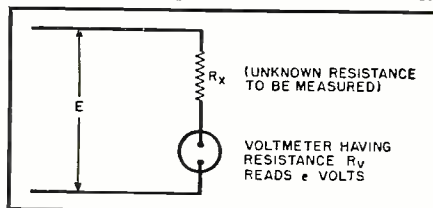

## BARGAINS IN OUTSTANDING SURPLUS ELECTRONICS!

### 50 W. 6-CHANNEL RADIOTELEPHONE

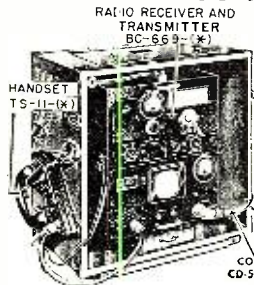

**THE BIGGEST BARGAIN IN PLEASURE OR FISHING BOAT RADIOTELEPHONES!** LAST CHANCE to get a sensational value in a big-power ship-to-shore Radiotelephone. This Transmitter-Receiver (BC-669, part of SCR-543) is beautifully and ruggedly built. Designed for rough military service and engineered for maximum efficiency, it will provide trouble-free long-range communications from boat, vehicle, portable or fixed station installations. Both Transmitter and Receiver operate in the frequency range of 1680 to 4450 KC, and both are crystal-controlled on all six channels in this range. Manual tuning of the receiver is also provided. Power Output (Phone) is rated nominally at 45 watts, but 50/60W. possible with 12 V. DC power supply listed below.

Transmitter operation is performed with a minimum of controls, after installation adjustments have been made, consisting of: ON-OFF Power Switch, CHANNEL SELECTOR Switch to proper position, and ANTENNA TUNING Control rotated for maximum indication in RF Meter. Furnished are instructions and drawing for circuit modification in anticipation of new FCC regulations concerning harmonic suppression of transmitters operating in the 2 and 3 MC marine band. Operation of the 45-Watt Radiotelephone may be from 110 V. AC, 110 V. DC, 32 V. DC, 24 V. DC, or 12 V. DC. Complete constructional data and diagrams are furnished for building any of the above power supplies at mill-manufactured power supplies. Telemarine will be glad to furnish quotations for any of the above voltage inputs. Each set is supplied with 12 crystals (6 for receiver, 6 for transmitter) and 6 crystals (6 for receiver, 6 for transmitter) for 2082, 2280, 2340, 3422.5 and 4255 KC. Receiving crystals. Receiver uses high-efficiency 10 Tube Superhet circuit with RF Stage for maximum marine band frequencies. Includes a built-in loudspeaker. Static Filter (Noise Eliminator) Circuit with Switch, and RF Gain Control. Transmitter uses 8 Tubes (2-807's in Final) with 100% Plate Modulation, and Metering Switch with multi-range milliammeter for instant checking of any part of transmitting circuit.

**45-WATT RADIOTELEPHONE (BC-669A, B, or C Models)**, complete with all tubes, crystals (as specified), Inst. Book, Connecting Cord—CD-515 (to Power Supply), Modification and Power Supply Constructional Data. **USED, GOOD CONDITION.** Shpg. wt. 18 1/2 lbs. **\$99.50**  
EACH  
**SAME, NEW UNUSED CONDITION** . . . . . \$139.50  
**MODELS BC-669 D or E**, Same as Above, but provides also V.T. Book, teletype transmission and reception (incorp. BFO). **NEW, EACH** . . . . . \$159.50  
**TS-11 HANDSET**, with appropriate plug connector. **EACH** . . . . . \$14.50

**POWER SUPPLY KIT FOR 12 or 24 V. DC.** Includes 12/24 V. Transmitter dynamotor (output 54 V. at 450 MA.) Receiver dynamotor, filter choke, filter capacitors, switches, fuse holders, all necessary material except chassis. **NET. \$45.00**  
**RM-21 REMOTE CONTROL**, as shown, less Handset. **EACH** . . . . . \$7.95  
**PE-110 A, B, or C, 110 V. AC POWER SUPPLY** **EACH** . . . . . \$99.50  
**PE-110 D, 110 V. AC POWER SUPPLY.** **EACH** . . . . . \$110.00

### 3-RANGE SIGNAL GENERATOR

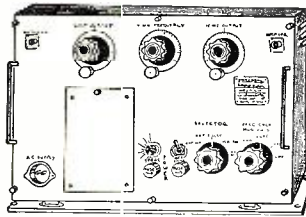

Well-built and highly engineered, this test signal generator is a rare, hard-to-get gain for laboratory or service shops, and for production testing in electronic factories. Known as the OAV-1 Test Generator, it provides any of 3 outputs: (1) a V.H.F. output, (2) a V.L.F. output, (3) a V.M.F. output, which can be changed to another nearby frequency for TV-IF alignment; (4) a V.L.F. output of 1.0, 10.0 and 100 IC by means of a selector switch. Frequency stability is excellent and calibration at least as good as any excellent service signal generator. Includes following tubes 1-6Y3GT, 6X4, 6SL7, 6AV6, and 2-9002. Operation is from 110 V. 60 cycles. 1-phase AC. Dimensions: 19 1/2" H, 13 3/4" W, 7 1/2" D. Shpg. wt. 85 lbs. **NEW UNITS**, with operating instructions and schematic. **ONLY** . . . . . \$24.95

able from 150 to 250 mc.; (2) a 15 mc. output, which can be changed to another nearby frequency for TV-IF alignment; (3) a V.L.F. output of 1.0, 10.0 and 100 IC by means of a selector switch. Frequency stability is excellent and calibration at least as good as any excellent service signal generator. Includes following tubes 1-6Y3GT, 6X4, 6SL7, 6AV6, and 2-9002. Operation is from 110 V. 60 cycles. 1-phase AC. Dimensions: 19 1/2" H, 13 3/4" W, 7 1/2" D. Shpg. wt. 85 lbs. **NEW UNITS**, with operating instructions and schematic. **ONLY** . . . . . \$24.95

### MOBILE FM RECEIVER



This is a "honey" in receivers, for hams, police cars, firemen, and moving photographers who want to get there first for prize photos. It's complete with built-in loudspeaker, speaker control, speaker-phone switch, sensitivity control, variable frequency tuning for each channel of 4 channels (permits pre-setting of 4 channels, covering a range of 27.0 to 35.0 mc. By taking a half-turn of each of the 4 channels, the range can be extended to 42 or 43 mc. Operates from 300 to 110 V. AC and includes dynamotor. Schematic diagram on bottom of each case. Dim.: 11 1/2" H, 8 1/2" W, x 12 1/2" D. Shpg. wt. 60 lbs. **NEW UNITS** . . . . . \$39.50  
**USED, LIKE NEW** . . . . . \$32.50

### 12 V. DC DYNAMOTOR FOR HAM-MOBILE, MOBILE PA SYSTEMS, MARINE X'MTTRS, ETC.

**OUTPUT 625 W. DC at 225 ma.** These Dynamotors are NEW-UNUSED, 3/4" COP. Type DM-25 and ruggedly designed for long service. Ideally suited for application in portable or mobile transmitters, sound systems, etc. Incorporates mfg. plate and Jones commutator. Dimensions: 4 1/2" x 4 1/2" x 4 1/2" high. Shpg. wt. 17 lbs. **PRICED REAL LOW**, for New Material! **EACH** . . . . . \$13.95

### INFRA-RED IMAGE "SNOPERSCOPE" TUBE EXTRA-SPECIAL !!

We've sold thousands of them to Labs., experimenters, industrialists, studios, etc. By using Infra-Red rays, this tube enables you to see in the dark. No scanning, no amplifiers, just a high-voltage power supply, all you need with this tube. Shows image in green-white on 13 1/2" screen. For night photography, signaling, snoper or sniper scopes, underwater detectors, etc. British mfr. **SOLD IN LOTS OF 6 ONLY.** Literature and diagrams furnished with each sale. Shpg. wt. 2 lbs.  
**Slashed to 3 for \$10.00**  
**FRONT-END LENS**, for Infra-Red Tube. **EACH \$7.00**

All Above Material Subject to Prior Sale. 25% Minimum Deposit with All C.O.D.'s. Min. Order—\$5.00. All Prices F.O.B. Our Address.

**TELEMARINE COMMUNICATIONS CO.**  
3030 W. 21st Street, Brooklyn 24, N. Y.  
Phone: ES 2-4300

### SELECTIVE RINGER FOR MOBILE or MARINE RADIOTELEPHONES

Permits Phone Operator to call your Radiotelephone exclusively, when operator has a call for you, by ringing a bell or lighting a light. Designed & Mfd. by Western Electric Co., modern, efficient, and reliable. Can be attached to any receiver, complete instruction Book supplied. Dim.: 15 1/2" long, 8 1/2" high, 5 1/2" wide. Shpg. wt. 25 lbs. **NEW UNITS**. Price value \$245.00 each. **OUR LOW PRICE—EACH** . . . . . \$85.00

### 24/28 V. DC POWER SUPPLY & MODULATOR FOR MARINE, ETC.

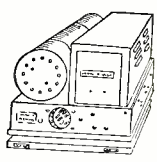

Designed for use with the TA-12 Aircraft Transmitter, this unit includes a full dynamotor type power supply output 540 V. DC, at 450 mA, with filters and starting relay, and a 2-stage audio amplifier-modulator using a 6N7, a 6F6, and 2-807 Final Modulator Tubes—with modulating transformer. Can be used to operate and modulate a marine or aircraft transmitter, or as a complete unit for use as a mobile or marine PA amplifier operating from 24 V. DC. Shock mounted on complete chassis. Dim.: 10" L x 9" H x 8" D. Shpg. wt. 40 lbs. **NEW, UNUSED UNITS. EACH** . . . . . \$29.50

### LIMITED QUANTITY BARGAINS

**WESTERN ELECTRIC 60 W. LOUSPEAKER UNITS.** Shock and Blast-Proof. For Horn or flat-bottom mfg. Response favors hi-freq. to 7,000 cps. Impedance 13 ohms. Dim.: 6" x 6" x 4 1/2" deep. Throat opening 1 3/8" Diam. Shpg. wt. 16 lbs. **NEW UNITS** . . . . . \$5.95  
**600 W. AUDIO POWER AMPLIFIERS.** Bell Labs Design, in wooden chest for rugged field use. Use 4-805 Power Tubes in push-pull parallel. Incorporated power supply uses selenium rectifiers for high voltage, and operates from 115 or 230 3 phase AC. 60 Watt Pre-Amp, required to drive to full output. Input Impedance 100 ohms. Output Imped. 13/6.5 Ohms. Dim.: of chest 24 1/2" x 28 1/2" x 21 1/2". Shpg. wt. 27 1/2 lbs. **NEW** . . . . . \$169.50  
**CONDENSER MICROPHONE.** With 2-Stage Amplifier. Quality constructed for low-frequency Amplifier. Ranging or Detection application. Response widened and extended by removing microphone from brass case. Uses 30 and 32 tubes (not supplied in 2-Stage Amplifier). **NEW UNITS.** Shpg. wt. 25 lbs. **EACH** . . . . . \$11.95  
**32 V. DC to 110 V. AC ROTARY CONVERTERS.** Mfd. by Kato, for marine or farm use. With input and output filtering. Rated at 225 W. delivers to 300 Watts. Shpg. wt. 60 lbs. **NEW UNITS** . . . . . \$39.95  
**LINK 30-40 MC RECIVERS.** Built-in 110 V. AC Power Supply for any one frequency in 30-40 mc range, crystal-controlled. Designed for rack mfg., with built-in 110 V. AC Power Supply. **NEW-UNUSED** . . . . . \$49.50  
**COMMUNICATIONS CO. MODEL 82-D AM RCVR.** Similar to Wilcox CW-3, but with coils supplied will allow any one frequency in 3 to 5 MC range, crystal control. Designed for rack mfg. with built-in 110 V. AC Power Supply. **NEW UNITS** . . . . . EACH \$49.50  
**HALLICRAFTER HT-9 HAM TRANSmitters.** 100 W. CW. 75 W. PHONE. 2-43 MC. crystal-controlled, built-in 110 V. AC. power supply. Excellent condition. Tested. Only 2 in stock. **ACT FAST!** **EACH \$129.50**  
**RMCA-TRC-20 MARINE RADIOTELEPHONES.** For small boat installations—complete 4-channel crystal-controlled Transmitter-Receiver and two Vircapack Power Supplies in metal case. Dim.: 13 1/2" x 11 1/2" x 9 1/2" H. 2-3 mc coverage. 5-10 W. output. Operates from 12 V. DC. Less Handset. **USED-GOOD** . . . . . \$44.50  
**RMCA-TRC-21 MARINE RADIOTELEPHONE.** For medium-size boat installations. 25 W. output. 6-channel crystal-controlled. Transmitter-Receiver in one case (power supply separate) dim.: 22" L x 13 1/2" D. 2-3 mc. H. Used-Excellent Condition. Less power supply. **\$89.50**  
**RMCA MODEL DAE DIRECTION FINDERS.** for marine applications. Frequency range 240-2000 KC. in 3 bands. Super-sensitive superhet receiver with BFO and built-in 110 V. AC power supply. Use inverter or converter to operate from 12 V. 24 V. 32 V. or 110 V. DC. Loop length 13 1/2" loop extension 30". Shpg. wt. 14 lbs. **NEW.** Case dim.: 8 1/2" H x 14" L x 14 1/2" D. **NEW, UNUSED** . . . . . EACH \$150.00  
**BC-41 HALLICRAFTER MARINE RADIOTELEPHONE** 2-3 mc. 4 channels crystal control (also manual or crystal control of receiver). 25 W. output. Has built-in 110 V. AC power supply, but can be operated on 12 V. or 32 V. DC by means of separate rotary converter. With handset. **USED-GOOD condition.** **EACH \$89.50**  
**HALLICRAFTER 10LFA AIRPORT RADAR BEARING TRANSMITTER.** Similar to BC-320 for small airports. 175 to 500 KC. 25 W. output. Operates from either 12 V. DC or 110 V. AC. **NEW.** **EACH \$99.50**  
**VHR-401A VHF COMMUNICATIONS RECEIVER.** by Technical Devices Corp. for Airport Tower communications. Range 109 to 144 MC, precision tuning by means of National Microometer dial. Beautifully designed and constructed. Operates from 110 V. 60 c. AC. **NEW-UNUSED** Acquisition cost over \$600.00 each. . . . . \$160.00



# PEAK JAN. SALE

## SMALL PIONEER GENEMOTORS

Ideal for Amateur or Commercial Service 5.5 to 6 volt DC input—output 400 volts at 175 MA cont. or 275 MA intermittent duty. Comes complete with A & B filters, RF hash filter & internal cooling fan. . . . . each **\$19.95**  
Same as above—with 11.5 to 12 volt DC input . . . . . each **\$12.95**

## 1" MINIATURE METER

High quality meter made by International Instrument Co. Mounts in a 1" hole like a pilot light. Basic movement 0-10 mills. Can be shunted to any milliamper range. . . . . **\$2.95**  
0-10 Mil. Special. . . . . **\$2.95**

## WESTON 1 1/2" MINIATURE METER

MODEL 1011—A fine meter suitable for compact grid dipper, field strength, many other applications. 0-500 Microamps. . . . . ea. **\$4.50**  
0-1 Milliamper. . . . . **\$3.95**

## ADVANCE ANTENNA RELAY

1000 series, silver plated contacts, D.P.D.T.—has third set of contacts normally open. Insulated throughout with Isolantite. Operates on 110 **\$2.95**  
Volts AC 60 cycles. BRAND NEW. . . . . each **\$2.95**  
2 for **\$5.50**

ALLIED 110 VAC 60 cy 12 V. DYNAMOTOR CON-  
RELAY. 4 Pole D.T. Con- TACTOR. A rugged relay  
tacts pure silver. 15 completely encased. Will  
amp. . . . . \$1.75 start any 12V Dynamotor.  
Heavy contacts. \$1.75 ea.

## G. E. RELAY CONTROL

(Ideal for Model Controls, Etc.)  
Contains a sigma midget 8,000 ohm. relay (trips at less than 2 MA), high impedance choke, bi-metal strip, neon pilot and many useful parts. The sensitive relay alone is worth much more than the total **\$1.25** Each 10 for **\$9.90**  
low price of. . . . .

## SENSITIVE RELAY

5000 ohm coil operates on 1 ma, adjustable contacts, adjustable armature tension. SPDT-Bake-rite Base. Ideal for model work. . . . . **\$1.75**  
Can also be used on AC. Draws ea. **\$7.50**  
4 mill AC @ 110 V. Ideal for burglar alarm . . . . . 5 for **\$7.50**

WESTON MODEL 1021 H. S. 2 1/2" meter with a basic 0-1 mil movement. **\$2.95**  
SPECIAL

## OIL CONDENSER SPECIALS BRAND NEW

2 MFD 600 VDC \$1.50	2 MFD 2000 VDC \$1.50
4 MFD 600 VDC .75	4 MFD 2000 VDC 3.50
8 MFD 600 VDC .95	1 MFD 3000 VDC 1.85
10 MFD 600 VDC 1.19	4 MFD 3000 VDC 6.95
2 MFD 1000 VDC .85	1 MFD 3800 VDC 2.25
4 MFD 1000 VDC 1.25	3 MFD 4000 VDC 5.95
8 MFD 1000 VDC 1.50	4 MFD 4000 VDC 7.95
8 MFD 1500 VDC 1.95	5 MFD 330 AC (1000 DC) .95
10 MFD 1400 VDC 2.50	8 MFD 660 AC (2000 DC) 1.95

## NEW PANEL METERS

G.E., WESTINGHOUSE, W.E., SIMPSON, etc.  
2" METERS 2" METERS  
0-100 Microamp. \$5.95 0-8 Volts DC \$3.95  
100-0-100 Microamp 3.95 25-0-25 Volts DC 3.95  
0-40 Volts DC 3.49 0-1 1/2 Millamps. 3.95  
0-1 Mil. 3.95 0-10 Millamps. 3.95  
0-1 1/2 Mil. 2.95 0-15 Millamps. 3.95  
0-35 Mil. 2.95 15-0-15 Millamps. 3.95  
0-200 Mill AC 2.95 0-50 Millamps. 3.95  
0-300 Mill. 2.95 0-300 Millamps. 3.95  
10-0-10 Amps DC 2.95 0-500 Millamps. 3.95  
0-15 Volts AC 2.95 0-15 Amps DC 3.95  
0-300 Volt AC 3.95 0-15 Volts AC 3.95  
- 10 to +60DB. 3.95 0-50 Volts AC 3.95  
0-4 Amps R.F. 3.49 0-150 Volts AC 4.50

## SHIELDED CHOKES

12 Henry 150 Ma. . . . .	\$1.65
8 Henry 200 Ma. . . . .	1.95
Thoradson 15 Henry 200 Ma. . . . .	2.25
6 Henry 300 Ma. . . . .	2.95
6 Henry 1200 Ma (12KV ins.) . . . . .	22.50

WESTINGHOUSE RF meter 2 1/2" bakelite case. 2 1/2" 50 bakelite case.  
Int. thermo. Seal linear An outstanding value  
from 1-9 amps, 0-9 amps. 0-40 Volts. . . . . \$2.95  
\$2.95 ea.; 2 for \$5.50 2 for \$5.50

## READ 'N' SAVE BARGAINS

500 MMF CERAMIC CONDENSERS .10 for \$5.50  
150 MMF Var. Cond. Diodes (Inst.) . . . . . \$69  
SANGAMO FEL .001 5000 VOLTS WORKING—  
TRANSMITTING MICA CONDENSER. . . . . 1.95  
25 WIRE WOUND RESISTORS in KIT . . . . . 3 for .95  
01 MMF 1000 VDC MICAS. . . . . 5 for .95  
0004 2500 VDC MICAS . . . . . 5 for .95  
04 600 V. MICAS . . . . . 3 for .95  
100,000 OHM 100 WATT RESIST. . . . . .45  
GLOBAR 9 OHM 100 WATT (non-inductive). 6 for 1.45  
OHMITE WIRE WOUND (non-inductive) 250 OHM  
100 WATT 59c ea. . . . . 5 for 2.50  
1 MFD Oil Condenser 400 VDC. 25c ea.; 10 for 2.00

ALL MERCHANDISE SOLD ON A 10 DAY MONEY BACK GUARANTEE BASIS

Min. Order \$3.00—25% with Order—F.O.B. New York.

# PEAK ELECTRONICS CO.

66 West Broadway, New York 7, N. Y.  
Phone WOrth 2-5439

nary multimeter is used, the method is, in general, much less sensitive, primarily because such instruments are usually designed to have constant "ohms-per-volt" so that their input resistance varies with the range in use. For example, assume a meter of 20,000 ohms-per-volt sensitivity, with 300 volts applied to the series circuit as before. If we use the 1-volt range, then for 0.1-volt reading we would have:

$$R_x = [(300/0.1) - 1] 20,000 \times 10^{-6} = 60 \text{ megohms}$$

If we use the 100-volt range, then for a 10-volt reading (same percentage indication) we would have

$$R_x = [(300/10) - 1] 20,000 \times 100 \times 10^{-6} = 58 \text{ megohms}$$

Actually, of course, for such instruments used in this manner, the sensitivity is essentially independent of the range used, provided the unknown resistance is large in comparison with that of the meter. It is not advisable to use the low ranges on such instruments if there is any possibility of the test specimen (as in the case of capacitors or vacuum-tube leakage paths) breaking down and subjecting the meter to full circuit voltage. However, well-designed vacuum-tube voltmeters will not be harmed by such an occurrence when working at ordinary voltages since tube current in such instruments is limited to values which will not damage the meter, and there will normally be a sufficiently large isolating resistor in series with the input grid to prevent damage to the tube. In any case an inspection of the meter circuit will determine whether it is safe for this usage.

Where very high supply voltages (of the order of several thousand) are used, as for testing insulation on high-voltage apparatus, the meter can be adequately protected by using a high-voltage supply designed for a maximum current output on the order of 10 milliamperes or less, and by shunting the meter input circuit with a neon lamp or VR tube which will break down harmlessly if the voltage across the meter exceeds a safe value. Further consideration of such specialized high-voltage methods is beyond the scope of this article.

For most purposes, a few hundred volts will be adequate for the detection of leakage in even good quality capacitors. In the writer's opinion, capacitors intended for coupling service should be considered unsuitable if their insulation resistance, when measured at maximum operating voltage, is less than 1000 megohms. Tests of surface leakage may be expected to give widely varying results, since values are greatly influenced by humidity, temperature, and surface contamination. Tests for leakage between vacuum-tube elements should be made with normal heater voltage applied and after normal warm-up time. Care should ordinarily be taken not to apply voltages in excess of tube ratings. In testing capacitors, and insulation generally,

Two important steps  
toward achieving  
better sound . . .

## the marantz power amplifier

40 WATTS

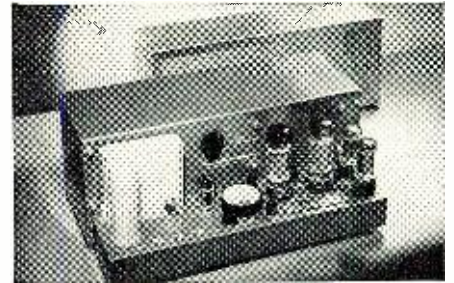

A power amplifier which  
meets the unusually high  
performance standards now  
recognized in the

## marantz audio consolette

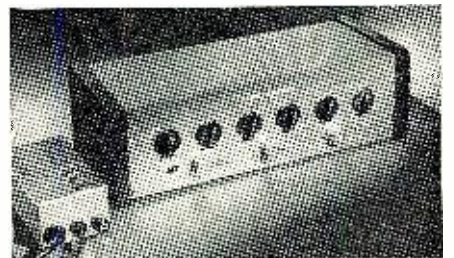

. . . combine them for  
superb sound quality

### POWER AMPLIFIER

- Superior performance and construction

net \$189

### AUDIO CONSOLETTE

- New Tape-Monitoring switch!
- Finest performance and construction
- Hum-free operation

net \$162 . . .

without cabinet \$147

See your audio dealer or  
write for specifications

## marantz company

44-15 VERNON BLVD. • LONG ISLAND CITY, N.Y.



it must be remembered that "insulation resistance" is greatly affected by a number of factors such as the magnitude, polarity, and duration of application of the test voltage, the temperature, and in precise work, on the immediate previous dielectric history of the test specimen.

In using this method with applied voltages greater than perhaps 50 volts, the usual safety precautions should be observed. It is good practice to work with one hand only, at one time, and to stand on an insulating floor, which may well consist of a dry wooden platform supported an inch or two above floor level on wood cleats, if work is done on a concrete or basement floor.

It is generally desirable to use power supplies having a maximum current output of 8 or 10 milliamperes, however, if larger supplies are used, a suitable series resistor can be used to limit the current. Fluctuations in supply voltage will cause erratic readings when testing large capacitors, so that for capacitor testing, batteries or else electronically-regulated supplies are desirable.

-30-

## RECORD FLOAT

By ARTHUR TRAUFFER

LESS surface-noise and longer record and stylus life are the rewards when you float your records about 1/8" off the surface of the turntable, as shown in the photograph. The record grooves never touch the turntable so the grooves cannot pick up dust, lint, flock hairs, etc., from the turntable. Since this float is made of sponge rubber 1/8" thick and only 4" wide, there is less chance of turntable rumble being transmitted to the phone pickup through the record.

Get a small amount of 1/8" green U.S. "Non-Slip" under-the-rug material from your rug and furniture dealer; they often have scraps and small leftovers so it isn't necessary to buy a large amount. Cut a disc 4" in diameter or about the same diameter as the record label. To do this easily, find a tin can 4" in diameter, lay the can on the sponge rubber and then cut around the edge of the can with a sharp razor blade. Now punch a hole about 9/32" in diameter in the exact center of the disc; this is for the turntable spindle. To do this, find the exact center of the disc using a compass or dividers, file a sharp edge on one end of a thin-wall metal tube of the required diameter, and simply twist the tube through the sponge rubber. This cuts out a neat hole.

-30-

Use of a 4" diameter rubber float protects records against wear, cushions turntable.



Bob Henry,  
WQARA  
Butler, Mo.



Ted Henry,  
WGUOU  
Los Angeles



NOW . . . HENRY DARES TO GIVE YOU THE ABOVE GUARANTEE . . . Try any receiver for 10 days. If you are not perfectly satisfied, return it and all you pay are shipping costs.

# hallicrafters

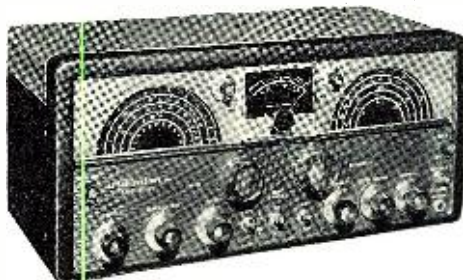

**NEW**  
**SX100**

For top performance with extra pull power and ability to tune in stations.

**\$29.50 Down**

20 monthly payments of \$14.65  
\$295.00 Cash Price

A few items in stock for immediate shipment are:

Model	Cash Down	20 Monthly Payments	CASH PRICE
S38D	5.00	2.47	\$ 49.95
S53A	9.00	4.45	89.95
S85	12.00	5.94	119.95
SX99	15.00	7.42	149.95
SX96	25.00	12.37	249.95
SX62A	35.00	17.32	349.95
R46B speaker			17.95
HT30	49.50	24.50	495.00
HT31	39.50	19.55	395.00
S94-S95	6.00	2.97	59.95

Write, wire, phone or visit either store today.

Butler 1, Missouri  
Phone 395



# Henry Radio Stores

GRanite 7-6701  
11240 West Olympic Blvd. Los Angeles 64



"WORLD'S LARGEST DISTRIBUTORS OF SHORT WAVE RECEIVERS"

YOUR COPIES OF



ARE VALUABLE!



Keep them neat...clean...  
ready for instant reference!

Now you can keep a year's copies of RADIO & TELEVISION NEWS in a rich-looking leatherette file that makes it easy to locate any issue for ready reference.

Specially designed for RADIO & TELEVISION NEWS, this handy file—with its distinctive, washable blue Kivar cover and 16-carat gold leaf lettering—not only looks good but keeps every issue neat, clean and orderly.

So don't risk tearing and soiling your copies of RADIO & TELEVISION NEWS—always a ready source of valuable information. Order several of these RADIO & TELEVISION NEWS volume files today. They are \$2.50 each, postpaid—3 for \$7.00, or 6 for \$13.00. Satisfaction guaranteed, or your money back. Order direct from:

**JESSE JONES BOX CORP., DEPT. RN**  
Box 5120  
Philadelphia 41, Pa.  
(Established 1843)



# BUILD 16 PRINTED CIRCUIT AND METAL CHASSIS RADIO CIRCUITS

only \$19.95 complete

## With the New Deluxe 1956 PROGRESSIVE RADIO "EDU-KIT"

Build 16 Receiver, Transmitter, Code Oscillator, Signal Tracer, Signal Injector Circuits

- No Knowledge of Radio Necessary
- No Additional Parts Needed
- Excellent Background for TV
- Learn High Fidelity
- Used in 79 Countries
- School Inquiries Invited
- Learn Practical Radio Theory, Construction

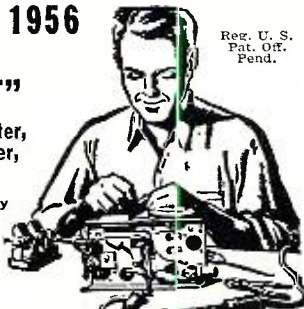

Reg. U. S. Pat. Off. Pend.

**FREE RADIO AND TELEVISION SERVICING LITERATURE ON REQUEST (See Coupon Below)**

### WHAT THE "EDU-KIT" OFFERS YOU

Our Kit is designed to provide a fundamental background in radio, with the basic facts of Radio Theory and Construction Practice explained simply and clearly. You will gain a knowledge of basic Radio Principles involved in Radio Reception, Radio Transmission and Audio Amplification. You will learn how to identify Radio Symbols and Diagrams; how to build radios, using regular radio circuit schematics; how to mount your radio parts; how to wire and solder in a professional manner. You will learn proper chassis layout. You will learn Printed Circuitry. You will learn how to service and trouble-shoot radios. You will receive training for F.C.C. Novice License. You will learn High Fidelity. In brief, you will receive a practical basic education in Radio, worth many times the small price you pay.

### THE KIT FOR EVERYONE

The Progressive Radio "Edu-Kit" was specifically prepared for any person who has a desire to learn Radio. The Kit has been used successfully by young and old in all parts of the world. It is not necessary that you have even the slightest background in science or radio. The Progressive Radio "Edu-Kit" is used by many Radio Schools and Clubs in this country and abroad. It is used by Armed Forces Personnel and Veterans throughout the world. The Progressive Radio "Edu-Kit" requires no instructor. All instructions are included. All parts are individually boxed, and identified by name, illustration and diagram. Every step involved in building these sets is carefully explained.

### "LEARN BY DOING"—PROGRESSIVE TEACHING METHOD

The Progressive Radio "Edu-Kit" comes complete with instructions. These instructions are arranged in a clear, simple and progressive manner. The theory of Radio Transmission, Radio Reception, Audio Amplification and servicing by Signal Tracing is clearly explained. Every part is identified by illustration and diagram. You will learn the function and theory of every part used. The Progressive Radio "Edu-Kit" uses the principle of "Learn by Doing." Therefore you will build radio circuits, perform jobs, and conduct experiments to illustrate the principles which you learn. These circuits are designed in a modern manner, according to the best principles of present-day educational practice. You begin by building a simple radio. The next set that you build is slightly more advanced. Gradually, in a progressive manner, you will find yourself constructing still more advanced multi-tube radio sets and doing work like a professional Radio Technician. Altogether you will build Receiver, Transmitter, Code Oscillator, Signal Tracer, Signal Injector Circuits—16 in all. These sets operate on 105-125 V. AC/DC. For use in Foreign Countries having 210-250 Volt Source, and Adaptor for 210-250 V. AC/DC operation is available.

### THE PROGRESSIVE RADIO "EDU-KIT" IS COMPLETE

You will receive every part necessary to build 16 different radio circuits. Our "Edu-Kits" contain all tubes, tube sockets, chassis, variable, electrolytic, and paper condensers, resistors, tie strips, coils, hardware, tubing, Instruction Manuals, Printed Circuit Material, etc. Selenium rectification is used throughout. No solder or wire included. Every part that you need is included. These parts are individually packaged, so that you can easily identify every item. A soldering iron is included, as well as an Electrical and Radio Tester. Complete, easy-to-follow instructions are provided. All parts are guaranteed, brand new, carefully selected and matched. In addition, the "Edu-Kit" now contains lessons for servicing with the Progressive Signal Tracer and Signal Injector, F.C.C. instructions, quizzes, High Fidelity Instructions.

### TROUBLE-SHOOTING LESSONS

Trouble-shooting and servicing are included. You will be taught to recognize and repair troubles. You will build and learn to operate a professional Signal Tracer and Signal Injector. You will receive an Electrical and Radio Tester, and learn to use it for radio repairs. While you are learning in this practical way, you will be able to do many a repair job for your neighbors and friends, and charge fees which will far exceed the cost of the "Edu-Kit." Here is your opportunity to learn radio quickly and easily and have others pay for it.

### Printed Circuitry Now Included

You build a Printed Circuit Signal Injector, a servicing instrument that can detect many Radio and TV troubles. A Printed Circuit is a special insulated board on which has been deposited a conducting material which takes the place of wiring. Various parts are plugged in and soldered to terminals. This new process is now popular in commercial radios, TV, hearing aids, industrial electronics, etc.

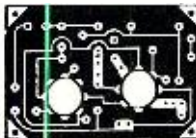

### FREE EXTRAS

- RADIO AND ELECTRICAL TESTER • ELECTRIC SOLDERING IRON
- HIGH FIDELITY GUIDE • QUIZZES • CONSULTATION SERVICE
- TESTER INSTRUCTION MANUAL • TELEVISION BOOK

### 30 DAY UNCONDITIONAL MONEY-BACK GUARANTEE

#### MAIL TODAY—ORDER SHIPPED SAME DAY RECEIVED

- Send "Edu-Kit" Postpaid. I enclose full payment of \$19.95.
- Send "Edu-Kit" C.O.D. I will pay \$19.95 plus postage.
- Send me FREE additional information describing "Edu-Kit." Include FREE valuable Radio and TV Servicing Literature. No obligation. (Outside U.S.A.—No C.O.D.'s. Send check on U.S. bank or Intern't'l M.O. "Edu-Kit" for 105-125 V. AC/DC \$20.95; 210-250 V. AC/DC \$23.45.)

Name .....  
Address .....

### PROGRESSIVE "EDU-KITS" INC.

497 Union Ave., Room 49E, Progressive Bldg., Brooklyn 11, N. Y.

## Certified Record Revue

(Continued from page 70)

The Janzen Company of Cambridge, Mass., exhibited two models of electrostatic speakers at the Show, one with a crossover at 1000 cycles and one with a 500 cycle crossover. These are fairly small, compact units about 18" by 6" in attractive wooden cabinets, and contain the speaker units and the necessary power supply and amplifier. The whole reasoning behind electrostatic speakers is that they can be made virtually distortionless, albeit with low efficiency. This lack of distortion results in a fabulously "pure" sound. The smoothness is quite indescribable when compared with the conventional type of tweeter, and possibly the most alluring aspect of all is the miraculous way in which string tone is smoothed, with all the wiry "edge" that so many people dislike in hi-fi systems absent to the point where it can truthfully be compared to tape. When properly adjusted with a good woofer, these Janzen units have all the characteristics mentioned above. The kicker is that the Janzen units are somewhat difficult to balance with the more efficient woofers. I understand this situation is being corrected in the assembly-line run on the production models.

Quite unexpected was the electrostatic speaker from Pickering. This is an entirely different concept than the Janzen, being much larger in radiating area. There are two models here, the 1000 cycle and 400 cycle crossover units. The 1000 cycle is about 12 by 18 inches, but only about 2½ inches thick and slightly curved. The 400 cycle model, which I find the most exciting speaker development to come along in some time, is roughly 2 by 3 feet by 2½ inches thick and also slightly curved. This is a tremendous radiating area when compared with conventional speakers and the effect is sensational. It is almost impossible to get out of the range of the high frequencies and it is even quite difficult to pinpoint the source of the sound if it is heard alongside several other speakers. A crossover network and power supply comes with each unit and has a high-low switch with an attenuator which makes the job of balancing very easy. I have one of the 400 cycle units working in perfect balance with a Jim Lansing D130, a notably efficient woofer. With the crossover this low, the woofer has a very easy job and the lows benefit in cleanness and articulation. When properly balanced (the Pickering units are on short stands that can be placed atop any speaker cabinet) there is no sensation that two separate speakers are operating. When first heard, one is inclined to think that the units are a little deficient in highs, but closer listening reveals the highs are there all right (both the Janzen and the Pickering units are flat almost to 30,000 cycles!). What fools one is the incredible smoothness and after listening to these electrostatic jobs for awhile other speakers seem strident. There is no doubt that the future of speaker development lies with these electrostatics. Response below 400 cycles is difficult to achieve at present, but indications are that within a few years we will have all-electrostatic speakers with response below thirty cycles!

I have already mentioned Pickering's new "Fluxvalve" pickup, which was very widely used at the show in various exhibitor's rooms. Electrosonic had their professional model arm and cartridge in wide use and much comment was made of its clean sound. Weathers showed a new viscous-damped arm for his new ruggedized cartridge and also an induction-tuned oscillator which eliminates any problems of drift. Also new is the Weathers speaker, which is a unit that can easily be fitted into apartments and other places where size is of primary consideration. In spite of its modest size, it puts out a remarkable bass from a specially horn-loaded driver and the over-all sound is very smooth and brought much favorable comment.

H. H. Scott showed his new line, nicely integrated as to styling and with several remarkable buys in amplifiers. Incidentally, because of their low internal impedance, Scott amplifiers work particularly well with the Pickering electrostatic speaker, as a few listenings revealed. The prize in the Scott line is their cute little 311 FM tuner. An attractive unit, it has shown remarkable performance as a wide-banded type at a moderate price. Marantz showed an unusually well-designed amplifier as a companion unit to his superb audio console. A novel feature is the ability to satisfy both schools of thought on amplifier design. Connected one way the unit is a 20 watt triode; a few reconections and it's a 40 watt beam type amp. It looks and sounds good, with typical Marantz attention to quality details. Fairchild showed a new turntable which I am most eager to try. A sort of modification of the Components Corp. table, it has certain features which would make for greater ease of mounting and operation. Speaking of Components Corp., they were showing their fine table in a new chairside model and according to reports had made improvements in bearings and drive system. Jim Lansing followed up their highly successful D123 speaker with a new design tweeter and crossover for same. Of course, their handsome "Hartsfield" was much in evidence in display rooms around the show.

Electro-Voice exhibited several new speakers, the most interesting of which was the "Centurion," a sort of scaled-down version



of the "Georgian." Whopping bottom end for a moderate-sized speaker, and good and solid to about 35 cycles. Speaking of bass, the most fantastic unit at the show was the gargantuan *Stan White* 4-D speaker. Stan was guilty of some outrageous levels of sound, but at least he can be partially excused as he was busy showing people how his speaker handled the full output of a 200 watt *McIntosh*! This 4-D is really loaded—the first speaker I've heard that can actually get close to the long-sought-after 16 cycles. A cute trick—Stan balances a nickel on its edge and then plays huge volumes of organ music, which doesn't bother the nickel a bit since there are virtually no cabinet resonances with the new 4-D system!

Speaking of friend *McIntosh*, he was there with his fabulous new 60 watt and they were much in demand by various exhibitors for demonstrating their speakers, etc. Also shown at Mac's room was the new *Microlab* turntable, which is evidently some tie-in with *McIntosh*. Good design, straightforward and business-like, these are attractive buys and I hope to have the opportunity of testing one before too long. *Rek-O-Kut* showed its "Rondine" line of tables and a remarkably balanced new arm, which should enjoy a terrific sale since it is quite low-priced and is small enough to fit with a small table in an average changer drawer. *Jensen* gladdened the heart of the do-it-yourself-crowd by making available a kit for their splendid "Imperial" speaker. There are just the "inner works" in this case . . . the three speakers and associated crossover networks and balance controls. Also available were complete constructional plans for the "Imperial" enclosure. Speaking of kits, I should have mentioned that *Electro-Voice* has set the market on its ear with kits for their various speaker enclosures up to and including the "Patrician." These are reportedly the complete deal—all parts pre-cut, fastenings, glue, furniture finishing material, etc. Not for a lazy guy like me, but at the low prices involved a boon for those who want to get good horn-loaded enclosures at a very moderate price. *Fisher* showed a new 30 watt amplifier which should enjoy a brisk sale at the price involved, but the new preamp is, I think, the gem of his new line. It is attractive, very quiet in operation, and with a high enough gain to operate many of the low-output cartridges directly without recourse to transformer boost. Real selling feature for many tape recorder and home movie fan is the ability to mix two or more channels of the *Fisher* simultaneously—a genuine boon!

There were many other items of interest, but space will not permit going into them at present. In a future column, I will tell you about *Jim Miller's* revolutionary new record press, where discs are turned out by a high frequency induction heating process literally "instantaneously."

Equipment Used This Month: *Pickering* "Fluxvalve" cartridge and 100 arm, *Marantz* preamp, *H. H. Scott* "Strobe" turntable, *McIntosh* 60 watt amp, *Stan White* 4-D speaker system.

Reviews will necessarily be limited this month due to the annual Audio Fair report. Next month will be 99 per-cent records and literally slews of them!

### BEETHOVEN SYMPHONY #3 (EROICA)

Chicago Symphony Orchestra conducted by Fritz Reiner. Victor LM1899. RIAA curve. Price \$3.98.

There is no doubt that this is the best sounding version now available. In fact, whether you care for the performance or not, this disc fills a long felt need for a really hi-fi "Eroica." The rich acoustics of Orches-



Write

FOR COMPLETE  
INFORMATION ABOUT  
THESE HALLICRAFTER  
MODELS . . . AND

SAVINGS  
OF UP TO  
**50%**  
ON WORLD RADIO'S  
RECONDITIONED  
EQUIPMENT

WRL's  
10%  
Down Payment  
Plan!

WRL's  
Globe King 503A  
Globe Scout 63A  
WRL's New  
VFO!

WRL's  
6 Meter  
Converter  
Low-Cost Beams  
Radio Map (25c)



Hallicrafters SX-99  
Only  
**\$11.92**  
per mo.  
Pay Just \$15.00 Down.  
Cash Price: \$149.95

## SPEND A hallicrafter holiday WITH "the World's Largest Distributor of Amateur Radio Equipment"

Hallicrafters S-38D  
Only  
**\$5.00**  
per mo.  
Pay Just \$5.00 Down  
Cash Price: \$49.95

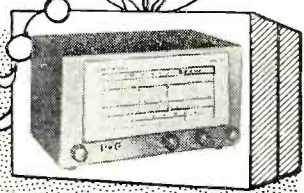

Hallicrafters SX-100  
Only  
**\$16.08**  
per mo.  
Pay Just \$29.50 Down  
Cash Price: \$295.00



Hallicrafters SX-96  
Only  
**\$13.62**  
per mo.  
Pay Just \$25.00 Down  
Cash Price: \$249.95



Hallicrafters HT-31  
Only  
**\$21.53** per mo.  
Pay Just \$39.50 Down  
Cash Price: \$395.00

Hallicrafters HT-30  
Only  
**\$26.98**  
per mo.  
Pay Just \$49.50 Down  
Cash Price: \$495.00

**FREE 1956 CATALOG!**



Please rush me:  Your latest FREE catalog and information on items checked below! Quote your top trade offer for my \_\_\_\_\_ (present equipment)

WORLD'S MOST PERSONALIZED RADIO SUPPLY HOUSE  
**World Radio LABORATORIES**  
on your \_\_\_\_\_ (New WRL Eqpt. Desired)

Hallicrafter Models  WRL's Globe King  
 Globe Scout  VFO  6 M. Converter  
 Beams  Radio Map (25c) R-1

Name: \_\_\_\_\_  
Address: \_\_\_\_\_  
City & State: \_\_\_\_\_

3415 W. BROADWAY, CO. BLUFFS, IA., Phone 7-0277

### CROWN TWO SET COUPLER

**\$3.45** another profit making TV accessory by CROWN

Pays off in those extra "over-the-counter" sales. Operates two TV sets from same antenna with excellent results on any combination of channels. No printed circuits! Coupling is by high efficiency induction . . . high-pass filter action . . . moisture proof treated. Internal signal loss negligible. Quick and easy to install.

CC8

**CROWN CONTROLS Co., Inc.** NEW BREMEN, OHIO  
Canadian Subsidiary Crown Controls Mfg. Ltd. Export Division, 15 Moore St., New York, N. Y., Cable "Mintborne"



AMERICAN TELEVISION & RADIO CO. ST. PAUL, MINN.

introduces the  
**new**

**ATR TV**

*Full Door Console  
Receiving Sets*

UNSURPASSED  
IN BEAUTY

UNEQUALLED  
IN PERFORMANCE

UNMATCHED IN  
QUALITY  
CONSTRUCTION

exclusive  
profitable  
dealer  
franchises  
now available



*designed  
with the  
Serviceman  
in mind  
... easy to  
get at*

WRITE TODAY FOR COLORFUL  
BROCHURE SHOWING THE  
NEW LINE OF ATR TV SETS

ALSO MANUFACTURERS OF DC-AC INVERTERS,  
"A" BATTERY ELIMINATORS, AUTO RADIO VIBRATORS

**ATR** AMERICAN TELEVISION & RADIO Co.  
*Quality Products Since 1931*  
SAINT PAUL 1, MINNESOTA-U. S. A.

tra Hall are admirably suited to this work and the sonorities generated are truly splendid. The strings are clean-lined, brass is weighty and full-blown, all other elements are reproduced with fine definition. Reiner has a few eccentricities in his reading, but they are not serious and this is a very satisfying performance. No, it hasn't the blaze and drive of the Toscanini disc, but taken all together the elements of good performance, superb orchestra, and the wide-range low distortion sound make this the most desirable "Eroica" in the catalogue.

**TCHAIKOVSKY  
SYMPHONY #6 (PATHETIQUE)**

Boston Symphony Orchestra conducted by Pierre Monteux. Victor LM1901. RIAA curve. Price \$3.98.

The same remarks as applied to the "Eroica" could well apply here, with slight modification. The indefatigable Monteux seems to get better as the years go by. This reading must certainly be reckoned as one of his finest achievements. His tempi, his phrasing and dynamics, and the fine orchestral balance leave little to be desired and combined with the best Boston Symphony sound to be heard on a disc, this is a richly rewarding "Pathetique." Competition-wise, only the Kubelik Chicago Symphony version stands comparison. I think that the Mercury disc, in spite of it being a good deal older than this, still has a slight edge in over-all sound quality, but performance-wise the honors must be shared about evenly. Perhaps what will decide many in favor of this version is the superb Boston strings, sounding better here than anything since the Koussevitsky days. Highly recommended.

**RICHARD PURVIS ORGAN RECITAL  
(VOL. 1)**

HI-FI R-704. RIAA curve. Price \$5.95.

This small West Coast label got off to a rousing start a few months ago with a fabulously good "pop" organ recording entitled, "George Wright Plays the Mighty Wurlitzer." It captured the essence of the mammoth theater organ as few recordings ever have and was an instant best seller. Now they follow up their "pop" effort with this excursion into the classical realm. The results are, to put it mildly, sensational! This Richard Purvis is not only a highly regarded organist, but a composer and arranger as well. This fact is attested to on this disc by his virtuosity on the organ, his arrangements of several orchestral works, and some of his own compositions. In such standards of the organ repertoire as the Purcell "Trumpet Voluntary" and the "Toccata" from Widor's "5th Organ Symphony," as well as the other material, Purvis shows his mastery of his instrument.

The most sensational thing about this disc, however, is the incredible sound. This is huge-organ-sound that a few years ago would have been impossible to cut on a disc. Using both Telefunken and the AKG microphones, the engineers of this disc have done the best job ever of capturing the roar of huge 32 foot contra-bombarde pipes. Of course, the organ itself is highly contributory to this success—a great *Aeolian-Skinner* installed in the Grace Episcopal Cathedral in San Francisco. Just to give you a rough idea of the pedal power available, there are 32 of the 32 ft. contra-bombarde pipes, 32 of the 32 ft. open diapasons and many more pedal stops with many pipes to each stop! I'll admit I listened to this recording through the fabulous *Stan White* 4-D, which is capable of reproducing the 16 cycles of these huge pipes, and I was literally blown off my feet with the tremendous shuddering realism of these pipes.

Since  
1933



Yokes



Flybacks



Transformers



**Authentic**  
**replacements**  
for Television . . .

all  
leading makes and models

.....

**AUTHENTIC REPLACEMENT IS**

- Always Right
- Easier to install
- Cuts service time
- Increases service profits

**SERVICEMEN!**  
Write Dept. RN for  
service hints. What  
are *your* problems?

Quality  
Controlled

**Todd**

**TODD-TRAN CORP.**  
MOUNT VERNON, NEW YORK



**8 MEN ON  
A HORSE**



C-10



C-15

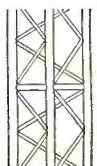

C-25

Here's proof of the strength of E-Z Way Towers. Photo shows C-10 tower section supporting 1200 pounds on horses 15 ft. apart. E-Z Way Towers are the sturdiest and most versatile in the industry. Write today for free catalog and price list. Catalogs available on Radio Broadcasting Towers (No. RN), Communication Towers (No. CN), TV Towers (No. TN), and Amateur Radio Towers (No. HN). Please specify catalog you desire.

**E-Z WAY TOWERS Inc.**  
P. O. Box 5491 • Tampa, Fla.  
Phone • 4-3916



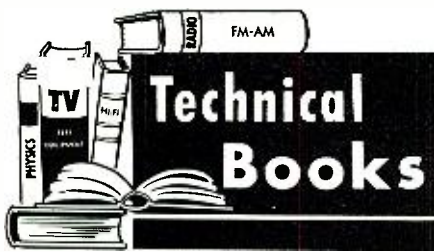

"AUTOMATIC RECORD CHANGER SERVICE MANUAL WITH TAPE RECORDER SERVICE DATA" by Sams Staff. Published by *Howard W. Sams & Co.*, Indianapolis. 288 pages. Price \$3.00. Paper bound.

This is the sixth in the current changer manual series and covers twenty different basic changers and recorders. As with the previous volumes, complete data is presented on the operation, adjustment, troubleshooting, and servicing of each unit. "Exploded views" of each unit are included along with photographs, parts lists, and a description of service procedures.

The changers or tape recorders of nineteen manufacturers, released during 1953-54, are covered in this volume.

"PROCEEDINGS OF THE SYMPOSIUM ON PRINTED CIRCUITS." Published by *Engineering Publishers*, New York. 122 pages. Price \$5.00.

This is a compilation of the papers presented by leading engineers at the recent symposium on printed circuits sponsored by the Engineering Department of the Radio-Electronics-Television Manufacturers Association and the Professional Group on Production Techniques of the IRE.

The papers cover both the theoretical and practical aspects of printed circuitry along with materials and components, design and production testing and evaluation, and reliability and management problems.

"AUDEL'S RADIOMAN'S GUIDE" by E. P. Anderson. Published by *Theo. Audel & Co.*, New York. 1040 pages. Price \$4.00.

This compact, hard-hitting reference manual covers radio, television, industrial electronics, and p.a. systems in a single volume. Since so much material is discussed in such relatively few pages, the presentation is, of necessity, concise. This in no way detracts from the value of the text but requires a little extra in the way of concentration on the part of the user.

A comprehensive index makes it possible for the user to locate information on any specific subject covered by the text. The material, as presented, can be used for self-instruction, as a classroom textbook, or as a reference manual for the practicing technician.

"TRANSISTOR ELECTRONICS" by Lo, Endres, Zawels, Waldhauer, & Cheng. Published by *Prentice-Hall, Inc.*, New York. 508 pages. Price \$12.00. This team of *RCA Laboratories'* engineers has provided an integrated



To insure only top quality merchandise Solar Electronics "set tests" each electron tube in powerfully loaded chassis.

Here Is Our New Guarantee Policy: Money back within 5 days of receipt of merchandise PLUS 5 year free factory replacement. ALL TUBES ARE CODED BY MONTH AND YEAR!

### ANTENNA SPECIALS

List \$845  
\$15!

Complete Outdoor ALL CHANNEL CONICAL

Includes: 8 element antenna with crossbar, 5 ft. seamless aluminum mast chimney mount or 7" wall bracket, 8 stand offs, 50 ft. of 300 ohm wire. State your need!

### NEW INDOOR ANTENNA

Brings in UHF and VHF. Use on Top of TV. List \$9.95

Your Price \$375

### Used TV SETS

Picture Tube Guaranteed To Work!

10" Set	Table Model	\$17.50
	Console	\$20.00
12" Set	Table Model	\$22.50
	Console	\$25.00
14" Set	Table Model	\$27.50
	Console	\$30.00
16" Set	Table Model	\$32.50
	Console	\$35.00
17" Set	Table Model	\$36.50
	Console	\$38.50
19", 20", 21" and 24" Sets		prices on request.

### Famous Make Test Equipment!

#### TUBE TISTER KIT

In carrying case

\$3325

Factory wired, \$44.95

#### VACUUM TUBE VOLTMETER KIT

\$2495

Factory wired, \$37.50

#### FLYBACK TRANSFORMER and YOKE TESTER KIT

\$2175

Factory wired, \$31.75

Test Equipment Factory Guaranteed for One Year!

#### EASY TERMS!

We pay all postage and freight in USA. Territories and APOs. 25c handling on orders less than \$5. Please send 25% deposit with C.G.D.'s. Remember! Your money cheerfully refunded within 5 days if you are not completely satisfied.

Visit our tube and parts showroom next time you're in Harrison. A free gift awaits you!

### PICTURE TUBE SPECIALS!

Brand New—RCA Licensed—One Year Guarantee

Type	Price	16CP4	17BP4	\$19.85
10BP4		or A	17CP4	\$20.85
or A	\$11.25	16DP4	17GP4	\$21.25
10FP4	\$14.95	or A	19AP4	\$23.95
12LP4		16EP4	19DP4	
or A	\$13.95	16GP4	or A	\$23.50
12QP4	\$13.95	16HP4	19FP4	\$24.25
12JP4	\$13.25	or A	20CP4	
12UP4	\$14.95	16JP4	or A	\$24.50
14BP4		or A	20DP4	
or A	\$15.95	16LP4	or A	\$24.50
14CP4	\$15.95	or A	21AP4	\$27.95
15DP4 (for Du-		16KP4	21EP4A	\$27.50
mont)	\$17.95	16RP4	21FP4	\$28.25
16AP4		16ZP4	21YP4	\$28.25
or A	\$18.95	or A	24AP4	\$44.95

All Picture Tubes Shipped FOB Harrison, N. J.

### BIGGEST VALUES! BIGGEST SELECTIONS!

Partial List Only!

Type	Price	Type	Price	Type	Price	Type	Price
0A2	.67	6A7	.35	6SH7	.43	12K7	.49
0D3/VR150	.90	6AB4	.45	6SJ7	.43	12Q7	.41
0Z4	.44	6AC7	.65	6SK7	.44	12SA7	.43
1A4P	.30	6AF4	.85	6SL7GT	.53	12SG7	.59
1A7GT	.45	6AG5	.50	6SN7GT	.53	12SH7	.59
1A2	.65	6AG7	.75	6SQ7	.37	12SJ7	.44
1B3GT	.63	6AH4GT	.65	6SS7	.43	12SK7	.43
1B4P	.88	6AH6	.65	6T4	.89	12SL7GT	.59
1C5GT	.45	6AK5	.57	6T8	.65	12SN7GT	.53
1D5GP	.40	6AL5	.38	6U8	.73	12SQ7	.35
1E7GT	.40	6AN4	1.25	6V3	.77	12V6GT	.35
1E7GT	.40	6AN8	.99	6V6GT	.44	12X4	.46
1H4G	.35	6AQ5	.45	6W4GT	.38	14A5	.90
1H5GT	.45	6AS6	1.50	6W6GT	.55	14A7	.44
1L4	.47	6AT6	.36	6X4	.35	14B6	.39
1L5	.53	6AU4GT	.70	6X5GT	.35	14E6	.59
1LA4	.55	6AU5GT	.60	6X8	.75	14E7	.59
1LA6	.55	6AU6	.40	6Y6G	.49	14F7	.57
1LB4	.55	6AU7	.85	7A4	.44	14F8	.69
1LC4	.51	6AV5GT	.65	7A5	.53	14N7	.69
1LH4	.55	6AV6	.36	7A6	.44	19B6G6	1.10
1LN5	.51	6AX4GT	.65	7A7	.44	19T8	.61
1NSGT	.53	6AX5GT	.59	7B4	.43	24A	.75
1R5	.58	6B8	.75	7B5	.40	25B06GT	.35
1S5	.41	6BA6	.45	7B6	.44	25CU6	1.10
1T4	.49	6BA7	.55	7B7	.44	25L6GT	.45
1T5GT	.57	6BC5	.50	7B8	.44	25W4GT	.42
1U4	.55	6BE6	.46	7C4	.44	25Z5	.39
1U5	.41	6BF5	.42	7C5	.44	25Z6GT	.35
1V2	.63	6BG6G	1.10	7C6	.44	26	.48
1X2	.65	6BH6	.52	7E5	.59	27	.29
2A7	.50	6BJ6	.49	7F7	.59	32L7GT	.53
2X2A	.55	6BK5	.65	7F8	.69	35	.32
3A4	.55	6BK7	.75	7H7	.69	35/51	.33
3A5	.55	6BL7GT	.69	7J7	.69	35A5	.44
3AL5	.48	6BN6	.60	7K7	.69	35B5	.48
3AU6	.48	6BQ6GT	.75	7N7	.54	35C5	.48
3BC5	.56	6BQ7	.80	7X7	.69	35L6GT	.45
3BN6	.65	6BY5G	.60	7Y4	.39	35W4	.35
3CB6	.56	6BZ7	.80	7Z4	.39	35Y4	.35
3Q4	.45	6C4	.35	12A7	.38	35Z5GT	.35
3Q5GT	.55	6CB6	.50	12A77	.65	37	.30
354	.52	6CD6G	1.10	12A6	.42	39/44	.35
3V4	.52	6CU6	.90	12A7	.52	50A5	.44
4BQ7	.92	6D6	.45	12AV6	.38	50B5	.48
4BZ7	.97	6F6	.40	12AV7	.73	50C5	.48
5A4Q5	.52	6H6	.42	12AX4GT	.67	50L6GT	.45
5J6	.60	6J4	1.50	12AX7	.69	75	.40
5U4G	.45	6J5	.38	12AZ7	.65	76	.40
5UB	.68	6J6	.50	12B4	.65	77	.40
5V4G	.56	6K6GT	.36	12BA6	.45	78	.40
5V6GT	.52	6L6	.65	12BA7	.59	80	.35
5X8	.78	6MGT	.74	12BE6	.45	84/624	.41
6Y3	.29	6SA7	.44	12BH7	.59	117L7GT	1.39
6Y4G	.35	6SC7	.50	12BY7	.64	117N7GT	1.29
5Z3	.40	6S P5	.60	12CU6	1.09	117P7GT	1.29

### FREE INTRODUCTORY GIFT!

Clip This Ad. With every order of \$10 or more: Popular 3 Tube Kit including 1R5, 1T4 and 3A4. With every order of \$25 or more: Popular "All American" Kit incl. 12SA7, 12SK7, 12SQ7, 35Z5, 50L6.

### TO QUANTITY USERS!

Your initial order of \$150 or more entitles you to our special discount OR free gift offer. Yes, either a Deluxe "60" Remington Razor (retail \$28.50) or 10% Discount is yours with \$150 or more order.

**SOLAR ELECTRONICS** Post Office Square  
Harrison, N. J.

ESsex  
4-5300



## Meet Hermon Hosmer Scott, Audio Pioneer!



Mr. Scott is well known for his significant contributions in measuring and reducing noise. Scott noise level meters and analyzers are widely used in industrial laboratories and Scott's remarkable invention, the Dynamic Noise Suppressor, uncannily eliminates noise from all records and poor broadcast reception without any loss of music. As every audiophile knows, Scott manufactures a most distinguished line of audio equipment.

Typical of the quality components that bear the Scott name is the versatile 210-D, a combination preamp-equalizer, power amplifier, Dynamic Noise Suppressor, and featuring unusually complete tape recording facilities. "In designing equipment for perfectionists," says Scott, "associated components must be of equivalent caliber. We find the wide dynamic range and tonal response of the Berlant Concertone most useful in our laboratory test and design work. Of equal importance, we find we can depend on it in continuous daily operation."

Visit your Berlant-Concertone distributor this week for a demonstration of the unusual features that have made Berlant-Concertone the first choice of audiophiles, according to a recent independent survey. The Concertone recorder is priced from \$445. The Berlant Recorder with hysteresis synchronous motor, specifically designed for broadcast and recording use, from \$595. Both recorders are available as complete sound systems with matching playback amplifiers and speakers. For detailed literature fully describing these recorders, write Dept. 5-J

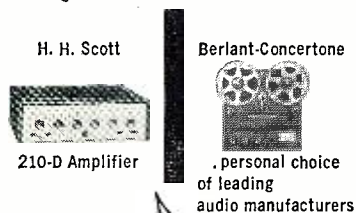

**Berlant Concertone**

Audio Division of American Electronics, Inc.  
4917 West Jefferson Boulevard  
Los Angeles 16, California  
Consult Recordata Division  
for industrial requirements

approach to both theory and practice of transistors and transistor circuits in this monumental work which includes, for the first time, some of the results of its original research.

The text material covers physical concepts; the characteristics, parameters, equivalent circuits; basic amplifier configurations; d.c. bias circuits; low-frequency amplifiers; power amplifiers; high-frequency operation; transistor parameters; high-frequency amplifiers; oscillators; modulation and demodulation; and pulse circuits. For a comprehensive coverage of transistor circuitry, this book would be hard to beat.

\* \* \*

**"ELEMENTS OF TELEVISION SERVICING"** by Abraham Marcus & Samuel E. Gerdler. Published by *Prentice-Hall, Inc.*, New York. 570 pages. Price \$6.95.

This book has been designed as an instruction manual for the radio technician who wants to enter the TV field, the student of radio and TV either at home or school, and the practicing technician who wants to brush up on television theory and practice.

The text is divided into four sections dealing with TV theory, field servicing, theory and practice of bench servicing, and color television. The material is presented in a thoroughly usable style with many diagrams and photographs being used to amplify the text material.

\* \* \*

**"RADIO SERVICING COURSE"** compiled by M. N. Beitman. Published by *Supreme Publications*, Chicago. 192 pages. Price \$2.50. Paper bound.

This book offers basic instruction in the servicing techniques required to repair and troubleshoot radio receivers. Since it is designed for beginners, the material is presented in as simple a manner as possible. Each part of the circuit is described in detail, its schematic symbol given, and an explanation of its function included.

Since self-testing questions are given at the end of each chapter, this text is entirely suitable for self-instruction and home study.

\* \* \*

**"TELEVISION RECEIVER SERVICING, RECEIVER AND POWER SUPPLY CIRCUITS,"** by E. A. W. Spreadbury. Distributed by *Iliffe and Sons, Ltd.*, London. 308 pages. Vol. 2. Price 21s.

Although concerned with servicing British TV receivers, this volume contains a great deal of material of interest and value to experienced American TV service technicians. It is a companion to Vol 1, which covered sweep circuits and circuits associated with the picture tube.

\* \* \*

**"FUNDAMENTAL FORMULAS OF PHYSICS"** edited by Donald H. Menzel. Published by *Prentice-Hall, Inc.*, New York. 765 pages. Price \$13.50.

A practical handbook and reference of physical formulas, carefully integrated to make the volume indispensable to researchers in all of the physical sciences. Typical sections, of which

there are 26, include basic mathematical formulas, electromagnetic theory, electronics, sound and acoustics, and nuclear theory.

\* \* \*

**"STATIC AND DYNAMIC ELECTRON OPTICS"** by P. A. Sturrock. Published by *Cambridge University Press*, New York. 240 pages. Price \$5.50.

An account of focusing in lens, deflector, and accelerator, this book first develops the theory of "geometrical" electron optics from clearly stated physical assumptions, and then proceeds with the focusing of particle accelerators.

\* \* \*

**"CIRCUIT ANALYSIS BY LABORATORY METHODS"** by Carl E. Sproder & M. Stanley Helm. Published by *Prentice-Hall, Inc.*, New York. 376 pages. Price \$5.75.

This is the second edition of a book designed as a guide and text in conjunction with a college laboratory course in electrical circuits. Experiments are presented in the form of problems rather than experiments in the usual sense of the word.

\* \* \*

**"NETWORKS, LINES AND FIELDS"** by John D. Ryder. Published by *Prentice-Hall, Inc.*, New York. 593 pages. Price \$7.65. Second edition.

This book provides a basic coverage of the theory of transmission of electric energy in lumped-constant circuits, on distributed-constant lines, through wave guides, and into space. It serves as an introduction to the field of communication circuit engineering and electrical network theory from the standpoint of both currents and fields.

\* \* \*

**"LAPLACE TRANSFORMS FOR ELECTRICAL ENGINEERS"** by B. J. Starkey. Published by *Philosophical Library*, New York. 279 pages. Price \$10.00.

The method of solving linear differential equations as described by Laplace over a century ago has been adapted to the solution of electrical engineering problems. A physical rather than a purely mathematical vocabulary is used, and a language and method of explaining problems is employed which is particularly familiar to electrical engineers.

\* \* \*

**"INTRODUCTION TO ELECTRONIC ANALOGUE COMPUTERS"** by C. A. A. Wass. Published by *McGraw-Hill Book Company, Inc.*, New York. 227 pages. Price \$6.50.

This basic work provides an excellent introduction to the subject of analogue differential analyzers and their components. Both theory and design are covered in the text, along with detailed descriptions on setting up computers for solving specific problems.

Standard computer components and the newer non-linear varieties are covered in some detail for the benefit of the engineering fraternity. —30—



# LIFETIME GUARANTEED TUBES

## BRAND NEW PICTURE TUBES

- RCA Licensed
- One Year Unconditional Guarantee

Type	Price	Type	Price
10BP4	\$11.90	17BP4	\$20.63
12LP4	\$14.38	19AP4	\$24.81
14BP4	\$16.86	21AP4	\$28.79
16RP4	\$19.38	21EP4	\$28.79
16LP4	\$19.38	24AP4	\$42.50

Picture Tubes shipped F.O.B. Harrison, N. J. Above types are most popular. However you may order any equivalent size at the same price.

## LOOK WHAT YOU GET FREE!

### FREE BONUS BOX With Every \$25 Order

- 1 RCA Cheater Cord
- 10 Assorted resistors
- 10 assorted 2 color "blank" tube cartons
- 1 6BQ6GT tube
- 1 6AU6 tube
- 1 6CB6 tube

### FREE CLOCK RADIO With Every \$125 Purchase Within 30 Days

Wakemaster clock radio with famous Sessions clock movement wakes you to music or alarm. May be purchased outright from MAJOR BRAND for \$17.95. In ivory or rust.

### FREE GIFT CERTIFICATE\* worth \$5 toward the purchase of any of our merchandise on future orders will be sent with any order of \$50 or more.

\* Free Gift Certificate cannot be used to obtain another certificate unless order is \$55 or more.

WE PAY ALL POSTAGE on orders shipped in USA, Territories and APO's. Send only purchase price of merchandise. Please include approximate postage on foreign shipments. All orders subject to prior sale. Add 25c handling on orders under \$5.00. Quantity users write for special discount.

Write For FREE Tube List—Order Blank—and FREE Sample Tube Carton. We want Y-O-U On Our Mailing List!

## NEW INDOOR ANTENNA

Both UHF and VHF. Brings better reception than most outdoor antennas. Use on top of TV.

List Price \$9.95

Your Price

Lots of 3 **\$3<sup>29</sup>**

\$3.99 each

## THIS AD IS WORTH M-O-N-E-Y

Clip out this ad and attach it to your order. Three 6SN7GT's will be shipped FREE with any order of \$10 or more.

## HERE'S HOW LIFETIME GUARANTEED TUBES SAVE YOU MONEY!

- We Guarantee to Replace Tubes Labeled MAJOR BRAND Forever
- Each Tube Individually Boxed and Guaranteed
- Over A Half Million Tubes Always In Stock
- Immediate Shipment
- Free Postage On All Orders With Full Remittance
- There are fewer "call backs"
- There are no "out of date" tubes
- "Peak Performance" testing in our fully equipped Testing Department before shipment guarantees quality

02A	.43	5AW4	.75	6BL7GT	.75	6X4	.34	12SK7	.45
1A4P	.33	5T4	.69	6BQ6GT	.78	6X8	.73	12SN7GT	.56
1A7GT	.43	5U4G	.43	6BQ7	.78	6Y6G	.55	12SR7	.45
183GT	.65	5Y8	.74	6BY5G	.58	7A4	.45	12V6GT	.45
1C5T	.41	5V4G	.59	6BZ7	.88	7A5	.53	12V7	.47
1D5GP	.43	5V3	.31	6C4	.37	7A6	.45	14A7	.42
1E7GT	.41	5Y4G	.36	6CS	.35	7A7	.43	14B6	.38
1G6GT	.42	5Z3	.41	6CB6	.49	7A8	.45	14T7	.50
1H4G	.43	5Z3	.41	6CD6G	1.15	7B5	.39	19B6GG	1.15
1HSGT	.47	6A7	.57	6C6G	.48	7B6	.41	19T8	.65
1I6GT	.47	6A8	.47	6E5	.44	7B7	.41	24A	.39
1L4	.45	6AB4	.43	6E5	.44	7B7	.41	25AV5GT	.78
1L6	.55	6AC7	.67	6F5	.37	7B8	.45	25LGGT	.47
1L4A	.57	6AF4	.79	6F6	.38	7C4	.39	25BQ6GT	.78
1LA6	.47	6AG5	.50	6G6	.40	7C5	.42	25W4GT	.43
1L8A	.57	6AG7	.69	6H6	.38	7C6	.43	25Z5	.37
1L6S	.42	6AH6	.69	6J4	1.79	7C7	.45	25Z6	.37
1LC6	.47	6AJ5	.70	6J5	.39	7E5	.45	27	.25
1LD5	.57	6AK9	.54	6J6	.47	7E6	.55	35A5	.46
1L3	.57	6AL5	.39	6J7	.43	7E7	.70	35B5	.50
1LG5	.57	6AQ5	.46	6J8G	.85	7F7	.59	35C5	.50
1LH4	.64	6AR5	.46	6K6GT	.37	7F8	.50	35CGT	.47
1LS5	.47	6AS5	.48	6K7	.39	7G7	.75	35D5	.50
1NSGT	.50	6AS6	1.70	6K8	.65	7H7	.50	35E5	.47
1RS	.50	6AS7G	2.19	6L6	.68	7J7	.75	35F4	.34
1S5	.42	6AT6	.39	6L7	.42	7K7	.75	35W4	.34
1T4	.50	6AU4GT	.85	6N7	.60	7L7	.75	35Z5GT	.34
1U4	.47	6AU5GT	.59	6O7	.40	7N7	.50	37	.29
1U5	.42	6AU6	.42	6S4	.43	1E7G	.37	50A5	.46
1V2	.65	6AV5GT	.65	6SA7	.45	12AT7	.66	50B5	.50
1X2	.61	6AV6	.39	6SC7	.48	12AZ7	.63	50C5	.50
1Y2	.55	6AX4GT	.60	6SK7	.41	12AU7	.53	50L6GT	.43
2A5	.57	6AX5GT	.57	6SH7	.43	12AV6	.35	75	.42
2A7	.55	6B4G	.52	6SJ7	.43	12AV6	.35	75	.42
2B5	.41	6B8	.69	6SK7	.45	12AV7	.67	78	.38
3A5	.50	6BA6	.47	6SL7GT	.55	12AX4GT	.65	78	.38
3AL5	.45	6BA7	.58	6SN7GT	.55	12AX7	.58	80	.34
3C5	.54	6B7	.47	6S7	.39	12B4	.68	84/6Z4	.44
3C6S	.54	6BC7	.80	6SR7	.42	12BA6	.46	117L7GT	1.09
3B86	.70	6BE6	.45	6SS7	.41	12BD6	.48	117N7GT	1.09
3C66	.52	6BF5	.40	6T4	.95	12E6	.46	117P7GT	1.09
3Q4	.46	6BF6	.50	6T8	.80	12BH7	.60	117Z3	.35
3Q5GT	.57	6BG6G	1.15	6U8	.75	12B7	.65	117Z6GT	.63
3S4	.47	6BH6	.50	6V3	.80	12BZ7	.61		
3V4	.47	6BJ6	.47	6V6GT	.46	12C6	.95		
4BQ7	.89	6BK5	.68	6W4GT	.39	12A7	.45		
4BZ7	.95	6BK7	.76	6W6GT	.53	12S7	.45		

Write Dept. 1-RN

**MAJOR BRAND TUBE CO.**  
Romano Bldg. ESsex 4-1106 Harrison, N. J.

# ATTENTION

- Electronics Classes
- Study & Employee Groups
- Service Technician Organizations
- Club Members

Subscriptions to RADIO & TELEVISION NEWS—the world's leading electronics magazine—are available at special bulk rates for schools, study and employee groups, clubs, etc.

For information, write to:

**RADIO & TELEVISION NEWS**

Dept. 1016, 366 Madison Ave.

New York 17, N.Y.

## The MASTER SETS YOU UP!

here's what's in it for you . . .

**DOLLAR-WISE PURCHASING**  
Shop before you buy! Do it right at your own bench through the supermarket pages of the industry-wide MASTER. Compare specs and prices first—then buy and save.

**A GOLD MINE OF FACTS** All the latest info on new products—new models—changes in specs. You name it and it's in the MASTER catalog file of the electronic parts industry.

- 100,000 items
- Complete descriptions
- Specifications—Prices
- 11,000 illustrations
- 350 mfrs.
- 8 x 11", 6 lbs.

List \$7.50  
As low as  
**\$2<sup>95</sup>**  
from parts distributors

UNITED CATALOG PUBLISHERS, INC.  
110 Lafayette St., New York 13



## 1956 edition

- FULLY CATALOGS:
- TUBES — TRANSMITTERS
  - TEST EQUIPMENT — COMMUNICATION
  - RECEIVERS — RESISTORS — COILS
  - ANTENNAS — TRANSFORMERS
  - RECORDING & PA SYSTEMS
  - CAPACITORS — HARDWARE
  - RELAYS — TOOLS, ETC.

**1456 pages**  
**OFFICIAL BUYING GUIDE OF THE INDUSTRY**



**new**

**low cost**

**deluxe**

**\$18.75**



## Adjust-A-Volt PA-3

### VARIABLE TRANSFORMER

For smooth continuous line voltage control for power supplies and instruments, control of heat, motor speeds, light, etc. The highly efficient new Adjust-A-Volt PA-3 is a modern, deluxe variable autotransformer designed for servicemen, laboratories, model shops and other applications where a source of variable a-c voltage is required. Max. load rating 0.4 KVA. Max. output current 3.0 A.

PA-3 features the new LoRes brush track plating which assures longer life and a special brush assembly that maintains constant pressure during entire brush life. Small and compact (6½" x 6½" x 6½"), the PA-3 is equipped with on-off switch, convenient fuse, cord and plug, receptacle and pilot light. Attractive grey hammerloid finish.

Delivery from stock of your favorite jobber.

**STANDARD  
ELECTRICAL PRODUCTS CO.**  
2238 E. THIRD ST. • DAYTON, OHIO, U.S.A.

## Antenna News

### NEW ELEMENT DESIGN

Trio Manufacturing Co., Griggsville, Illinois, recently introduced the "Zephyr Royal" TV antenna using a "wing" dipole to obtain wide-band operation over the v.h.f. range. These elements are stagger-tuned to six predetermined frequencies so as to obtain good performance throughout the v.h.f. band. On the low band, the "Zephyr

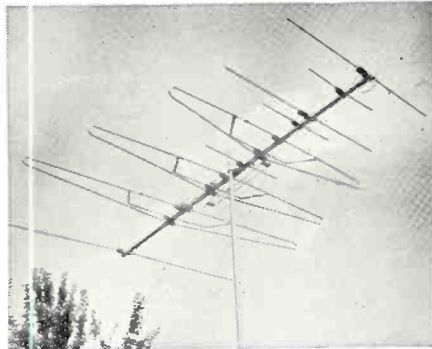

Royal" has three driven elements stagger-tuned to channels 2, 4, and 6, together with two directors and one reflector. Other than the "wing" dipoles, there are eight parasitic high-band elements. The three "wing" dipoles add a total of nine driven elements pretuned to channels 7, 10, and 13, together with three directors.

Additional information as well as price lists may be obtained by writing the company.

### HIGH GAIN ANTENNA

Channel Master Corp., Ellenville, N. Y., has announced a new v.h.f. yagi-type TV antenna, the "K.O.," which the company claims has the highest front-to-back ratios ever recorded for any TV antenna. There is a low-band model, No. 1026, for channels 2 through 6; a high-band model, No. 1073, for channels 7 through 13; and a broad-band model, No. 1023, consisting of the other two models stacked and connected with a "Tenna-Tie" coupling network.

A combination of element spacing and phasing is used to obtain for this

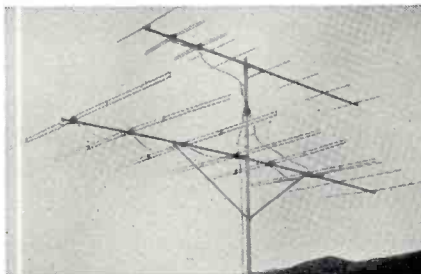

antenna its high front-to-back voltage ratios which range from 20:1 to 50:1 on the low band, and up to 13:1 on the high band. In addition, the an-

## HERSHEL SPECIALS

**All New MYSTERY PACKAGE**  
of ELECTRONIC PARTS

Worth \$40.00  
Our Price **\$3.95**  
Ship. Wt. 20 lbs.

It's the surprise of your life! 10 pounds of your brand new useful Gost surplus. The ideal gift for home, etc.

We now ship parcel post to save you more money!

### KIT SPECIALS

**KIT 1, HARDWARE**  
Over 1,000 pcs. Assorted For Radio & TV **99c**

**KIT 2, CERAMICONS**  
100 Assorted 75 mmfd. to 6,000 mmfd. **\$2.50**

**KIT 4, Rotary Switches**  
25 Assorted Tetricific Buy! **\$2.50**

**KIT 5, RESISTORS**  
100 Assorted 1 ohm to 15 meg. 1/2 to 5 watts **\$1.75**

**HI GAIN DYNAMIC MIKE KIT**  
Uses UTC Transformer and Western Electric Mike. Ideal for Home, PA, CAP, Recording, Mobile Equip. .50 DB/10-7500 CPS. Diagram Furnished **\$1.95**

**PHOTO ELECTRIC CELL**  
95¢ CE Vacuum Cell used in AMPRO Sound Projector. Also useful for opening garage doors and Alarm Systems.

### SWING CHOKE

**2H-7H-550 MA Thordarson T48003** **\$5.95**

**KIT 6, RF CHOKES**  
25 Assorted Range from .5MH to 25MH **95c**

**KIT 7, TOGGLE AND SLIDE SWITCHES**  
25 Assorted D.P.S.T.-D.P.D.T. S.P.S.T., etc. **\$3.25**

**KIT 8, PAPER AND OIL CONDENSERS**  
25 Assorted Range from 4Mfd.-150V to 80Mfd.-450V **\$2.75**

**KIT 9, KNOBS**  
100 Assorted Push-On and Set Screw types **\$1.75**

**KIT 10, MICAS AND SILVER MICAS**  
100 Assorted Range from 10Mfd. to 7500mmfd. **\$2.50**

**KIT 11, BATH-TUB OIL CONDENSERS**  
25 Assorted Range from 1 Mfd. to 2 Mfd. up to 600 VDC. **\$1.50**

**KIT 12, HI WATTAGE RESISTORS**  
20 Assorted Range from .75 ohm to 20,000 ohm, 10 up to 200 watts **\$3.25**

**KIT 13, TUBE SOCKETS**  
31-3-6-7-8-9 pin types **\$2.50**

**ALL-PURPOSE FIL-TRANSFORMER**  
PRI. 117VAC 60CY  
SEC. 6.4V.....12A  
6.4V.....3A  
5.0V.....3A  
5.0V.....3A  
2.5V.....1.75A  
**\$4.95**

**VARIABLE CONDENSERS YOUR CHOICE**  
100 MMFD-Double Speed size: 2 1/2" x 2 1/2" H. Hammett  
TYPE A  
Mfg. Veeta Root Counter  
3/4" Shaft 0-10 tuning for coil  
3 for \$1.00  
**95c**

**OIL CONDENSER**  
2 Mfd. 3000 VDC. Pyranol Oil W Mounting Brackets  
1-1 Mfd. 3000 VDC. New, removed from equip. Size 4 1/4" x 4 1/4" x 2 1/4"  
**\$1.65**

**ARC-5 COMMAND TRANSMITTER YOUR CHOICE**  
2.1 to 3 MC. 7 to 9.1 MC. Brand New in Cartons with tubes.  
**\$6.95**  
HOTTEST BUY IN THE COUNTRY

**AUDIO CHOKE**  
4500 ohm ideal for radio control, airplanes, boats, etc.  
Size 1 1/8" x 3/8" x 3/8"  
Wt. 1/2 oz.  
**95c**

**HERSHEL RADIO CO.** 5249 GRAND RIVER Detroit 8, Michigan Phone TYler 8-9400

**HERSHEL RADIO CO.** 5249 GRAND RIVER Detroit 8, Michigan Phone TYler 8-9400

### NEW PICTURE TUBES

RCA-LICENSED, 1-YEAR GUARANTEE:

Tube	Price	Tube	Price	Tube	Price
10BP4	\$11.95	16KP4	\$17.95	19AP4A	\$24.95
12LP4A	13.95	16RP4	17.95	19DP4A	24.95
12UP4A	19.50	16TP4	17.95	20DP4	24.95
14BP4	14.95	16WP4A	18.95	20HP4	25.95
14CP4	14.95	17BP4	18.95	20HP4	25.95
16AP4A	20.50	17CP4	22.50	21AP4	26.95
16DP4A	18.95	17HP4	19.95	21EP4	25.95
16EP4A	20.95	17LP4	19.95	21FP4	26.95
16GP4A	20.50	17RP4	19.95	21IP4	27.95
16LP4A	18.95	17TP4	19.95	21ZP4	25.95

Warranty backed by famous million-dollar factory. NOTE: We don't need your old tube. THESE ARE NEW TUBES. WITH SET OF 1-YEAR WARRANTY CARDS INCLUDED. Send money order for 25% deposit with order; we ship C.O.D. via Railway Express for balance. Write for free bargain parts catalog. All in ccs net, F.O.B. Boston, subject to change without notice.

**GLOBE ELECTRONICS**  
200 Washington St. Boston 8, Mass.



tenna has a 7 to 9 db gain on the low band, and from 8.5 to 10.5 db on the high band. These figures are for the single bay.

The "K.O." is preassembled and features "Snap-Lock" action. It is of 100% aluminum construction, and the low band model is boombraced with high temper seamless aluminum tubing.

### BROADBAND ANTENNA

Finney Company, 4612 St. Clair Avenue, Cleveland 3, Ohio, is marketing a new v.h.f. TV antenna which features high gain and excellent front-to-back ratio for the elimination of the vene-

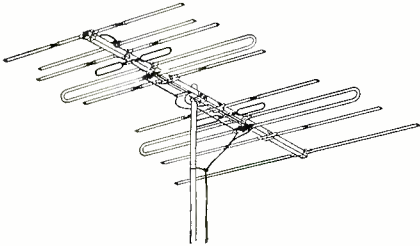

tian blind effect. This broadband antenna, specified as the Model B-8, uses a combination of reflectors, directors, and phasing elements in a colinear array giving sharp directivity. Broadband operation results from the use of elements cut to different sizes.

Self-locking and self-aligning aluminum alloy element brackets, and the "Lock-tite" saddle bracket are used for element and boom mounting.

Two stacking kits are available for use with this antenna. The Model No. S-830 is for maximum high-band gain, and the Model No. S-860 is for maximum low-band gain.

### PARAPET MOUNT

Kenwood Engineering Co., Inc., Kenilworth, New Jersey, was recently issued Patent No. 2717751 on the Kenco parapet mount Model No. 106. Designed to take antenna masts up to 1 1/2 inches in diameter, this mount can be

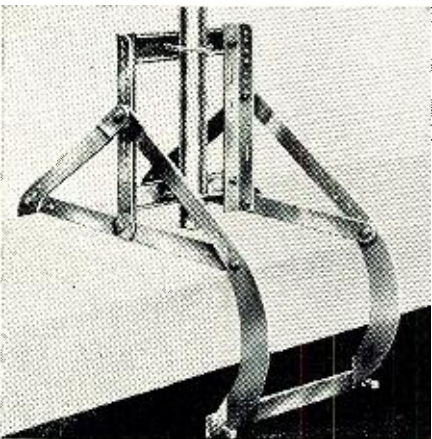

used on walls up to 13 1/2 inches thick.

The mount itself employs a sturdy frame with four clawlike members. At the end of each claw is a hardened cone-point set screw which assures positive anchorage to the wall. At each side of the frame is a cam that can be adjusted to prevent the mount from sliding sideways on tile or stone copings.

## COMMAND ARC-5 TRANSMITTER BC-458

Brand New.... \$495  
7 to 9.1 inc.....\$5.95

### LORAN EQUIPMENT

Marine or Airborne LORAN Range Navigational equipment! Determine the exact geographic position of your boat or airplane!  
AN/APN4 1 ran set. Frequency range 1700-2000 KC. complete with ID6B/APN4 indicator, R9B/APN4 receiver, crystal and plugs. Brand New \$129.50  
Complete.....Brand New \$295.00  
AN/APN-9 B and New.....\$295.00  
Quantity prices available—write!  
R-24/ARCS—Broadcast Receiver—520 to 1500 KC. broadcast band. 6 tubes: 3-12SK7, 12SR7, 12A6, 12K8, for dynamotor operation. Easily converted to 110 volt or 12 volt use. Two IF stages, 3-gang tuning cond. Brand new in sealed carton with tubes and instruction manual, less dynamotor. \$14.95  
Exc. .... \$19.95  
New .....

**MN-26-C** Remote Controlled Navigational Direction finder and communications receiver. Manual DF in any one of three frequency bands, 150 to 1500 KC. 24V. Self contained dynamotor supply. Complete installation, including receiver, control box, loop, azimuth control. Left-Right Indicator, plugs, loop transmission line and flex. shafts, oper. & main. manual. Ideal for use in boats, etc.  
BRAND NEW \$39.50  
MN-20-E Loop. Brand New..... 4.95  
MN-62, Crank Drive, New..... 2.95  
MN-26-C as is for parts..... 6.95  
MN-26-C Revr., New..... 12.95  
MN-28-C Control Box for above..... 6.95  
New .....

### Command Equipment (174N-ARC5, ATA)

Model	Less Tubes As Is	Excellent Used	Brand New
190-550 KC			\$14.95
520-1500 KC			19.95
1-6-10 MC		9.95	14.95
3-6 MC	\$2.95		
6-9 MC	2.95	3.95	
100 MC-15 MC		13.95	
<b>TRANSMITTERS</b>			
2.1-3 MC		9.95	
3-4 MC		6.95	
4-5.3 MC		3.95	5.95
5.3-7 MC		3.95	4.95
7-9.1 MC		3.95	5.95
100-156 MC		14.95	22.50
BC 456 Modulator		2.95	4.95
MD 7 Modulator.			7.95

## \$4500 HI-FI Headset for only \$4.95

Uses annular grooved plastic fiber cones with voice coils as in speakers and padded chamois earmuffs to obtain spacing for correct acoustical load.  
Gives finest music reproduction. 600 ohms. Check out.  
Exc. w/earpads.....each 4.95

**Radio Receiver** 11-tube UHF tunable 234-258 MC receiver with schematic.  
Complete with tubes 3 ea. of 6AK5, 7 ea. of 9001, 1 ea. of 12A6, Like new. \$6.95  
Less Tubes.....\$2.95—2 for \$5.00

**3" dual scale panel-meter**, 0-1 MA movement calibrated, 0-1 KV and 0-10 MA.  
Used—\$1.95 ea. New—\$2.95 ea.

### A Sweet Oscilloscope Deal

**INDICATOR UNIT.** For conversion to test scope, panadapter, analyzer, etc. Double deck chassis. 5CP1 mounted in tube shield. Less small tubes and crystal, but complete with 5CP1. \$9.95  
Exc. cond.....each

**25 watt phone**—CW 5 tube transmitter. Frequency range 2-9 MC. Two 815 tubes in circuit. One as modulator and one as RF output. Ideal for C. A. P. Mobile. Excellent condition, with tubes. Less TU's. \$9.95  
Wt. 24 lbs.....

### BC442—Antenna

**Relay Unit** complete with 50 MMF 5 AMP CONDENSER. New.....\$3.95 ea.  
Less Condenser.....\$1.95 ea.

**MP-28** modulation & power supply for the TA-12 transmitter. Complete with 4 tubes. Dynamotor has an output of 540 V. DC @ 456 ma. Input at 28 V. DC.  
With dynamotor.....\$14.95

**HS-23** Hi-Im headphones—Used, exc. ea. \$2.95  
**TS-F1** Hands—Excellent Model.....\$2.49  
**TS-9** Handset—Complete with cord & Butterfly switch. Brand New Original Cartons.....\$6.95  
10 for.....\$60.00  
**T-26** Mobile Chest Mike. Brand new.....\$1.29  
**TU26**—Excellent.....\$1.95

### BC-375 XMITTERS

200 to 500 KC. 1500 to 12500 KC., using plug-in units. 100 Watts, Voice and C.W. Complete with tubes. Less tuning unit. Used, exc. cond. \$14.95

**12 V. DC DYNAMOTOR** For Ham-mobile, Mobile X'mttrs., Etc. Output 625 V. DC at 225 ma. These Dynamotors are NEW/UNUS'D, Siz. Corp. Type DM-35, and ruggedly designed for long service. Ideally suited for application in portable or mobile transmitters, sound systems, etc. Incorporates mix. plate and Jones connectors. Dim.: 8" long x 4 1/2" deep x 4 1/2" high. Shpg. wt. 17 lbs. PRICED REAL LOW for New Material.....New \$12.45  
SAME DYNO AS ABOVE EXCEPT 28V DC Input. 8.45  
Used 4.95

**FM RECEIVER** 27 to 98.9 MC—Four Presettable Channels, Frequency Ranges 27 to 29.5—29 to 32—31.5 to 34.4, and 34.4 to 38.9 M. C. Complete with 16 Tubes and Crystal 1000KC.; Crystal, Calibrator and Speaker.....\$29.95  
New 12 Volt Dynamotor for above..... 5.95

### LOOK WHAT YOU GET FOR \$14.95

350 feet of continuous length of 50 ohm coaxial cable 90 feet of same coaxial cable.  
50 ft. attenuator  
6 Short lengths of RG8U with connectors and sockets. In wooden case—shipping weight 30 lbs.

**RG-8/U—COAXIAL CABLE**—52 ohms, 50 ft. lengths.....\$2.95

### OIL FILLED CAPACITORS

All from 600 to 1000 volts. 2 mfd at 1000 VDC. 4 mfd at 600 VDC. 4—4 mfd at 600 VDC. 8 mfd at 600 VDC. 12 mfd at 600 VDC. 20 mfd at 600 VDC, plus others. \$5.95  
10 for.....

### LEEDS NORTHRUP

Variable self inductance coil, 55 to 460 MH P/M 10MH. Brand New.....\$24.95

### DYNAMOTORS

Type	Input	Output	Used	New
BD-83	12 VDC	375-150 MA.	\$1.95	\$4.95
DM-35	12 VDC	625 VDC 225 MA	9.95	12.95
DM-37	24 VDC	625 VDC 225 MA	6.95	9.95
DM-64	12 VDC	275 VDC 150 MA	3.95	5.95
DM-34	12 VDC	220V 80 MA.	2.95	4.95

**MOBILE HEAVY DUTY DYNAMOTOR:** 14 V. INPUT-output: 1030 VDC 260 MA. Tapped 515 V. 215 MA. use or 6 V DC INPUT-500 V. 175 MA. While they last—DM-42-Excel. Condition. \$4.95  
Brand New.....\$9.95

**METER**—3"-0.5 Ma. 270° Indication—By Pass Shunt and add scale. Excellent Condition. .95c  
6 for.....\$5.00

### BRAND NEW

#### 10 tubes for \$2.50

Includes, 316A, 211, 801, 6C4, 6SK7GT, 954, 955, 957, 9006, 6SH7, 1629, 1625, 1626.

5CP1 3BP1 { \$2.95 ea.  
5BP1 3CP1 {  
5AP1 3CP1 { 4 for \$10.00

### LARGE CHAMOIS EAR CUSHIONS

For your headphones—brand new.....\$1.49

### APG 5 or 15 CAVITY

10 Cm. C243 osc Xmitter, C240 Loc. Osc. Rec. 1B27 TR; tubes 2400 to 3000 MCS, less tubes. Price.....\$4.95

### BEACON RECEIVER BC-1206-C

Complete with 5 tubes. Tunes 195 KC to 420 KC. IF Frequency—135 KC. Receiver Sensitivity—3 Microvolts for 10 Milliwatts output. Output Impedance—300 Ohms V. DC. 1000 Ohms V. AC. This diagram acts as a moving plate of the frequency modulator capacitor. W/instructions, build TV sweep sig. gen. BRAND NEW.....\$2.75  
2 for only.....\$4.95

**BRAND NEW, with Tubes.....\$9.95**

### FM WOBULATOR CAPACITOR

Frequency modulation unit with a permanent magnetic field and a moving coil mechanism driving a metal diaphragm supported at its rim. This diaphragm acts as a moving plate of the frequency modulator capacitor. W/instructions, build TV sweep sig. gen. BRAND NEW.....\$2.75  
2 for only.....\$4.95

**AN/APR5A**—Airborne superhet radar search rec. Freq. range 1000 to 6100 MC. Rec. has a 10 MC IF band width operating from 80/115V AC, single phase 60 to 2600 cps, and one amp. at 26V DC—complete with tubes.....\$250.00

**Lavoie VHF** 2-Tube battery operated portable frequency meter, designed to measure frequencies from 300-600 MC. This unit is used for variety of measurements on VHF circuits. Unit has a 0-200 microamp meter, time switch. All in metal carrying case, with modulation, Excellent.....\$14.95

**RA-10DA** Compass and Communication Receiver—Frequency range: 150-1, 100-KC., 2.0-10.0 MC. Complete with tubes, dynamotor.....\$49.50  
and control box, New.....

**CRYSTAL**—1000 KC, \$2.95

**CRYSTALS:** FT-241; FT-243; DC-34; DC-35; 100 assorted..... per kit \$9.95

**MG-149F**—110V AC, 400 cycle-750 VA Inverter, Used.....each \$9.95

### WRITE FOR NEW BULLETIN AND PRICES.

ALL ITEMS F.O.B. CHICAGO  
25% Deposit required with orders  
**R W ELECTRONICS**  
Dept. N, 2430 S. Michigan Ave., Chicago 16, Ill.  
PHONE: Calumet 5-1281-2-3



# NEWARK ONLY OFFERS THESE SPECIAL BARGAINS!



**Below Cost!**

Reg. \$66.50  
**Now 34.95**

### SPECIAL! V-M 160 PA SYSTEM

Unbeatable Buy! Never before priced so low! Powerful 8-watt "slide-out" amplifier and full-toned 10" Jensen Alnico V PM speaker in compact, portable case. Speaker features curvilinear cone. Amplifier has 2 inputs: phone, mike. Freq. resp.: 60-12,000 cps. Leatherette case: 13 1/4 x 9 x 14 7/8". Shpg. weight, 30 lbs.  
**R1901. NET ONLY.....34.95**  
**R1904. As above, with Model JT-30 microphone and connector. Tremendous saving! NET.....44.95**

### BIG VALUE! V-M 3-SPEED RECORD CHANGER



**Below Cost!**

Reg. \$64.50  
**Now 29.95**

Model 960. One of the most terrific money-saving buys of the year! Famous V-M Tri-O-Matic, 3-speed automatic record changer. Designed for use with Model 160 amplifier system above. Portable, scuff-resistant, water-proof case: 16 1/2 x 13 3/4 x 8 7/8". U.L. Approved. Shpg. wt., 19 lbs.  
**R1902. NET ONLY.....29.95**  
**R1903. Carrying case only, cut out for V-M Model 950. Ample for most changers. Now sensationally low priced at only.....3.95**

### SPECIAL PURCHASE! FAMOUS ESPEY HI-FI COMBINATION



Reg. \$123.50  
**Now 99.50**

**Save \$24.00!**

Newark's Hi-Fi Special Value consists of . . . Model 400 Deluxe AM-FM Tuner. Super-hot chassis designed for use with Model 500 amplifier below. Has preamp for use with reluctance type phono pickup. Complete with tubes, antenna, hardware. 13 1/2 x 7 3/4 x 10". Shpg. wt., 13 lbs.  
 . . . Model 500 Amplifier. Deluxe power supply and amplifier. Response: ±1 db, 20-20,000 cps. Operates on 105-125 v., 50-60 cycles AC. 13 1/2 x 7 1/2 x 9". 18 lbs.  
**R1900. Tuner and Amplifier, Only.....99.50**

F.O.B. Chicago. Include shpg. and ins. charges.

Send for Complete FREE CATALOG

**NEWARK**  
ELECTRIC COMPANY

Dept. R-1, 223 W. Madison St., Chicago 6, Ill.  
4736 West Century Blvd., Inglewood, California

## Tape Recording (Continued from page 67)

losses that occur in the tape recorder in question when bias is set to obtain maximum output at 1 kc. These losses, it will be remembered, are caused largely by demagnetization and bias erase.

Curve 2 shows the recorded magnetic induction implied by the NARTB playback standard. It corresponds to the curve *AE* in Fig. 3. Curve 2, it should be noted, attains a 6 db-per-octave slope at the high end. This slope is specified because the playback head characteristic has a 6 db-per-octave slope in the opposite direction, which is used to compensate the drop in recorded induction. Curve 2 represents an approximation of the maximum amount of induction that can be recorded at 15 ips consistent with low distortion and high signal-to-noise ratio. If the speed were 30 ips, the specified induction characteristic would begin to drop at a frequency twice as high as in the case of the 15 ips speed. In some recorders, flat induction is recorded at 30 ips.

Curve 3 shows the treble boost required in the record preamplifier in order to bring Curve 1 up to the level of Curve 2. Thus Curve 3 equals Curve 2 minus Curve 1. It may be noted that Curve 1 is slightly higher than Curve 2 in the area of 600 to 1600 cps, but this results in less than 1/2 db departure above flat response. The amount of treble boost required is 10 db at maximum. As will be made clear in the following section, such boost appears well within the limit for achieving low distortion and high signal-to-noise ratio.

Curve 2 has a turnover point (3 db down) at 3180 cps. Therefore the bass boost characteristic, shown by Curve 4, must have the same turnover point. Curve 4 eventually attains a slope of 6 db-per-octave, but then levels off as it reaches the lower limit of the audio range. The second turnover point, where bass boost is 3 db below the maximum, occurs at 50 cps. To compensate the resulting decline in bass playback response, Curve 5, there must be a corresponding bass boost in the record preamplifier, shown by Curve 6.

Curve 7 shows the playback response to the NARTB recorded induction if there were no bass boost in playback. It may be compared with the general curve *CB* in Fig. 3.

Curve 8 is the unequalized record-playback response of the 15 ips tape recorder in question. It can be obtained by adding Curve 1 (record losses) to Curve 9, which is the 6 db-per-octave playback characteristic for the head, assuming no treble losses.

Next month, the final article of this series will cover the problems of maximum permissible record boost, optimum magnetic induction, and the need for standard equalization.

(Concluded Next Month)

## SAVE UP TO 63% on TV PIX TUBES

- Standard RTMA 1-Year Guarantee
- Dark Face • No Trade-ins Needed

Sensational Bargain Prices in TV Pix Tubes—you save plenty of money—up to 63% Discounts. Your choice of dark Face (glare-ease) or Aluminized faces. These tubes are high-quality RCA-licensed re-built tubes—each guaranteed for 12 months. No trade-ins needed. Factory-sealed cartons with manufacturer's registration warranty in carton. Perfect arrival guaranteed by Railway Express.

Type * Grey-Face	Bargain Net
12LP4	\$11.95
16A, E, or GP4	16.95
16D, F, H, or JP4	18.25
16R, K, or TP4	16.95
17A or BP4	17.25
19AP4-Metal	24.50
20C or DP4	20.50
21A, D, or MP4-Metal	27.50
21E, F, K, W, X, Y or ZP4	23.50

\* Above types also available in new aluminized Pix tubes—add \$3 for 12" thru 17" sizes—add \$4 for 19" thru 21".

STILL AVAILABLE—National Electronics Sensational two-bay 16-element conical bargain, complete with stacking bars.  
 Three 2-bay arrays with the rods.....\$14.95  
 One 2-bay array with tie rods.....\$5.30

SEND FOR FREE 1956 CATALOG

**National Electronics**  
OF CLEVELAND  
**THE HOUSE OF TV VALUES**

6608 Euclid Ave. Dept. N-1 Cleveland 3, Ohio

To help you

## MOVE AHEAD in INDUSTRIAL ELECTRONICS

This Library makes plain methods used by today's electronics engineers

HERE'S a Library to help you prepare for a top job in the booming industrial-electronics field . . . help you save time and work in your present job. Experts give you basic theory, practices, and methods. They explain electronic circuits and devices, vacuum tubes, the analysis and use of electron-tube circuits, and provide a vast amount of other data on electronic equipment.

### INDUSTRIAL ELECTRONICS ENGINEERING LIBRARY

4 volumes, 1998 pages, 1637 charts, diagrams, and illustrations

\$24.95—payable on EASY TERMS

In this Library are the sort of practical facts that can help you step out in front of the "average" electronics man—they give the kind of help that could very well mean a top-paying job in electronics work.

You get practical data on electronic instrumentation, a wealth of facts on vacuum tubes, useful information on electron-tube circuits, and the basic laws of electronic motion. The basic knowledge here can be applied in radar, television, pulse communication, and a wide variety of general electronic control. Use coupon below for free trial—no obligation.

EASY • 10-DAY  
TERMS • FREE TRIAL

#### 4 Big Volumes

Cage's THEORY AND APPLICATION OF INDUSTRIAL ELECTRONICS

Harman's FUNDAMENTALS OF ELECTRONIC MOTION

Spangenberg's VACUUM TUBES

Seely's ELECTRON-TUBE CIRCUITS

McGraw-Hill Book Co., Attn.: H. W. Buhrow,  
Industrial & Business Book Dept. RTN-1,  
327 W. 41st St., New York 36, N. Y.

Send the *Industrial Electronics Engineering Library* for 10 days' examination on approval. In 10 days, I will send \$4.95 then \$4.00 monthly until low price of \$24.95 is paid. If not wanted, I will return books postpaid.

PRINT Name .....

Address .....

City.....Zone...State .....

Employed by .....

For price and terms outside U. S., write McGraw-Hill Int'l., N. Y. C. RTN-1

RADIO & TELEVISION NEWS



## Phonograph Evolution

(Continued from page 59)

matter of fact, its action was identical. A typewriter under development by Edison is also shown in the illustration.

In this model the governor has been added to the conventional Edison mechanism and may be seen directly in back of the feedscrew. This particular model was primarily intended for business use and it was during this period that Edison was keenly interested in his invention as an office dictating device. The accessories included are practically the same as for the earlier models, with the exception that the hearing tubes which terminated in small rubber inserts were now designed to be inserted into the ear. These were self-supporting. They later became standard equipment on the early Edison machines and were used for many years.

Another foot-powered phonograph of improved design is shown in Fig. 8. The major improvement was in the stabilization of rotation due to an improved governor. Note the pull-out drawer in the center of the treadle stand. This was required for the gathering of shavings when wax cylinders were prepared for re-use. Practically all of the early Edison models employed a shaving knife. This adjustable device could be moved into the rotating wax cylinder to remove previously recorded sound from the cylinder. The knife was made of sapphire.

A radical change in the design of Edison's phonographs is seen in Fig. 9. This particular model was known as the Model "M", "spectacle-type." It was powered by four electric batteries seen in the accessory box at the rear of the stand. Of particular interest is a new governor assembly seen at the top left of the mechanism which has a governor control and an electric switch used in combination to compensate for the varying current supplied by the cells as well as to provide means for adjusting the speed of the machine. The action of this device was described briefly in Part 1 of this series. Accessories included the spectacle recorder-reproducer, the speaking tube, and the hearing tube. It was sold during the year 1889 by the *North American Phonograph Company* of New York, sales agents for Edison.

One of the most interesting of all of Edison's phonographs is the one shown in Fig. 10, which was operated by water power. It was made in 1889 on an experimental basis and was sold the following year in small quantities. Two major changes are observed in addition to the unique method of driving power. One is the change to a single mounting for either a recorder or for a reproducer. The second development was the elimination of a separate feedscrew by threading the drive shaft supporting the mandrel which eliminated the necessity for additional parts. Two

January, 1956

## Use Your Military Training

*The time was never  
more opportune than now  
for becoming  
associated with the field  
of advanced electronics.  
Because of military  
emphasis this  
is the most rapidly  
growing and  
promising sphere of  
endeavor for the young  
electrical engineer  
or physicist.*

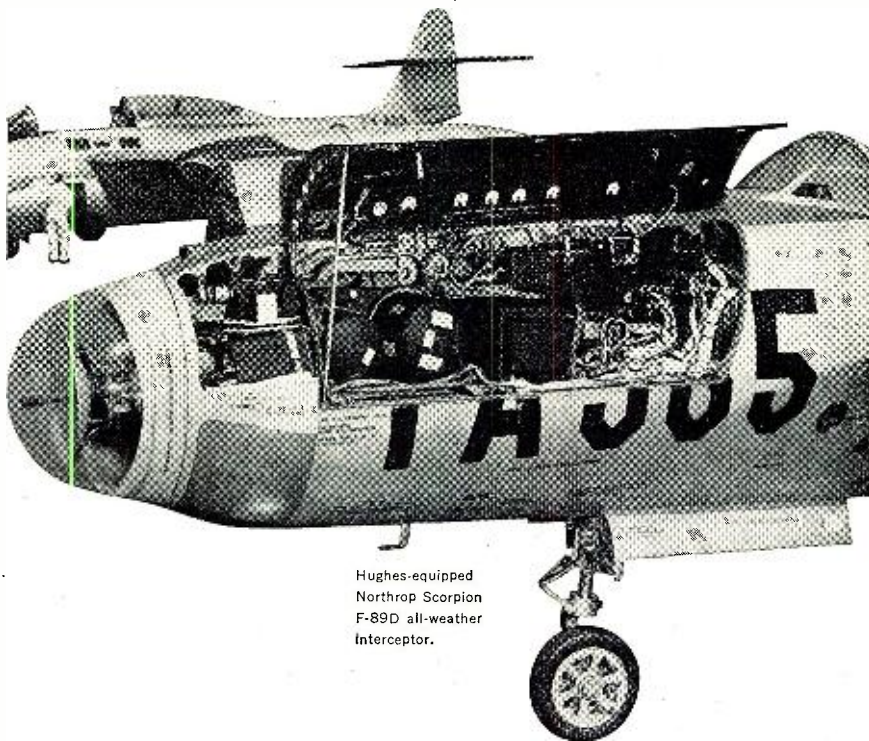

Hughes-equipped  
Northrop Scorpion  
F-89D all-weather  
Interceptor.

Scientific Staff  
Relations

# Hughes

RESEARCH AND  
DEVELOPMENT  
LABORATORIES

Culver City  
Los Angeles County  
California

### E.E. or PHYSICS GRADUATES

*with experience in*

### RADAR or ELECTRONICS

*or those desiring to enter these areas...*

Since 1948 Hughes Research and Development Laboratories have been engaged in an expanding program for design, development and manufacture of highly complex radar fire control systems for fighter and interceptor aircraft. This requires Hughes technical advisors in the field to serve companies and military agencies employing the equipment.

As one of these field engineers you will become familiar with the entire systems involved, including the most advanced electronic computers. With this advantage you will be ideally situated to broaden your experience and learning more quickly for future application to advanced electronics activity in either the military or the commercial field.

Positions are available in the continental United States for married and single men under 35 years of age. Overseas assignments are open to single men only.



# IN DETROIT IT'S AARON

## SYNCHRO DIFFERENTIAL GENERATOR

55DG 90-90 VOLTS, 400 CYCLE **\$5.95** ea.  
NEW-TAKE OFFS

4 FOR \$20.00  
8 FOR \$35.00 100 FOR **\$250.00**

### 701-A TETRODE. SIMILAR TO 4-125A

A dandy K.W. SSB final—fil: 8 V. @ 7.5 amps. plate: 3000 V. @ 200 MA. screen: 280 V. @ 50 MA. Just 10 W. to drive pair 1 K.W. A.M. phone. Max. input 600 W. per tube, class C. ampli. **\$2.95 EA. 2 FOR \$5.00.**

304 TL or TH Ceramic Sockets.....59c ea.  
3BP1 Tube.....\$1.95 ea.

### BC221 FREQUENCY METER CASE

Brand new in original carton with all contents and size the same as adv. in previous issues. But priced now at only..... **\$2.25**

BC-221 TECHNICAL MANUAL—  
NEW, Prepaid.....\$1.25

### A REAL SCOOP—6 METER TRANSMITTER



FREQ. 53.3 to 95 MC. 50 WATTS

Complete of doubles and amplifier section, with 3—815 tubes. Used as xtal osc. buffer, tripler, and final. Easily converted for 2, 10, or 20 meter. Can be used to drive higher power amplifier. Wt. 10 lbs. Brand new in original carton..... **\$13.95**

### TG 10 CODE KEYS

Same function as the TG34A, but larger and more audio output. Can be used as a high power audio amplifier or for group instruction of code. In a standard metal cabinet 11" x 24" x 8 1/4". Used, less tubes and photo cell. Metal cabinet alone worth the price. While they last..... **\$9.95**  
Same as above, excel. tested, with tubes **\$19.95**  
PRACTICE CODE TAPE for TG34A and TG10 Keys. On 16 mm 400 ft. reels, #1, #3, #5, #6, #7, #8, #11, #13, #15. New in metal container.....Ea. **\$1.25**

### MISCELLANEOUS

Attenuator, 500-500  $\pm$ , 1.5 watt, 60 DB range, 32 steps, adjustable..... **\$1.95**  
Vernier dial, Nat'l. 4-1 ratio..... **\$1.25**  
40 watt modulation transformer 2-1 ratio, matches 6L6's to 807's, etc. with driver and mike xfmer..... **\$3.95**  
Fil. conds. 8.8 MFD @ 600 VDC 4 prong. Plug in type..... **97c**  
PYRL 23 MFD @ 1000 VDC..... **\$7.95**  
PYRL cap. 1-1 MUF @ 3000 VDC..... **\$1.95**

### SIGNAL GENERATOR MODEL III

117 Volts—50/60 cycles. Freq. Range 20-40 MC and 185-215 MC Complete with Tubes and Manual. New in original carton..... **\$39.95**

### VARIABLE CONDENSERS

Ceramic Split Stator. Tunes 70-160 MC. Ideal 2 meter oscillator section, or antenna matching section in place of Batum as described in Hints & Kinks, volume 5, page 75, with 955 tube. **\$1.25**  
200 MMFD Double Bearing..... **79c**  
15 MMFD Split Stator with Coil. Freq. approx. 2 meter. Can be used with P.P. input circuits. **59c**  
Neutralizing Conds. Adjustable range. 0-25 MMFD, 1 3/4" dia. plates. 69c ea.; 2 for **\$1.25**  
75 MMFD APC type with long shaft..... **59c**  
3-13 MMFD APC type with long shaft..... **39c**

### HIGH FREQUENCY BROAD BAND IF STRIP

Complete w/5—717A tubes. Has mixer panel for 3—6AK5, 1—6SL7, 1—6SN7, tubes. Will make a dandy TV video amplifier. Plus—relay, coax plugs, etc. 14" x 4 3/4" x 4 3/4" sh. wt. 6 lb. Can be used for various other VHF applications. With 5—717A tubes. Only..... **\$4.95**  
With all the above tubes..... **7.95**

### COMMAND EQUIP.

2-1-3 MC ARC/5.....Brand New **\$5.95**  
7-9-1 MC ARC/5.....Brand New **5.95**  
3-3-7 MC BC 458.....Brand New **5.95**  
5-3-7 MC BC 458.....Like New **4.95**  
4-5-3 MC BC 457.....Excellent **4.95**  
Modulator BC 456.....Brand New **3.95**  
Splined Tuning Knob. For Above Rcvr..... **.89**

**NOTE** 25% deposit—bal. C.O.D. or mail full price, allow for postage and save plenty on C.O.D. collection charges.

## AARON ELECTRONICS

Dept. S. 3830 Chene St., Detroit 7, Michigan

"half nuts" are mounted to a flat spring which engages the feedscrew now cut by a lathe on the drive shaft.

The turbine-like water wheel is seen to the left in the illustration. A hose connected the device with a water faucet. The water wheel was coupled to a governor and could be adjusted to compensate for speed. It was during this period of Edison developments that the main assembly of his phonographs took on some form of standardization. It will be noted in models that followed that an attempt was made to simplify as well as to standardize his phonograph.

The same year, 1889, saw the development of his "Cylinder Phonograph," Model "E", Fig. 11. This was powered directly from 117 volt direct current house circuits. A crude rheostat seen at the left in the illustration reduced the line voltage to approximately two volts, which was the requirement of the motor. It operated at approximately three amperes. This model apparently had been in development for several years or was simply a modification of the early Model "M," originally designed for storage battery power. It did not contain the later improvements mentioned in the previous paragraph.

The model shown in Fig. 12, was designed principally for business. It was first produced in 1890 and was driven by means of an electric motor which

was powered from a special primary cell like the one shown in Fig. 12. This model, as well as the one shown in Fig. 11, were simply modifications of the old Model "M". This one still used the "spectacle-type" recorder and reproducer and was provided with an accessory drawer and a removable box to contain the shavings.

The Model "M" phonograph using a single housing for a recorder or a reproducer is shown in Fig. 13. This model never attained any great success on the market and very few, if any, will be found in existence today. It has been included solely for its peculiar appearance, especially with respect to the modification of the box or cabinet upon which the machine rests.

History records the development of the Edison phonographs in the following order: 1. hand-powered, 2. electric-powered, 3. foot-powered, 4. water-powered, 5. spring motor-powered, and 6. clock-work (abandoned). Subsequent chapters in this series will continue with the many spring-driven phonographs of Edison which became standard and were produced in great quantity from 1895 to 1912. Other chapters will include the developments of Eldridge Johnston and others.

*The authors will appreciate any "leads" as to owners of the above models. They are needed for a permanent collection.*

*(To be continued)*

Fig. 11. Standard 117 volt d.c. power (which was stepped down) was used to operate this Edison Model E phono.

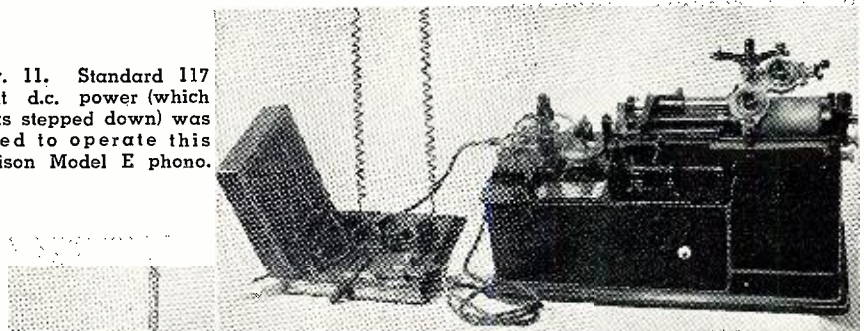

Fig. 12. Same phonograph as the Model E but this was powered by primary battery.

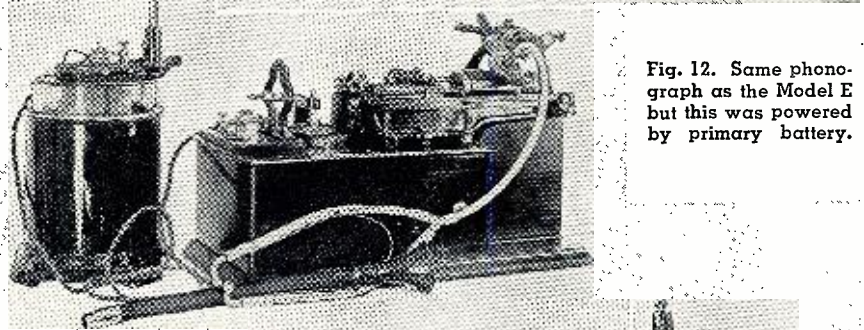
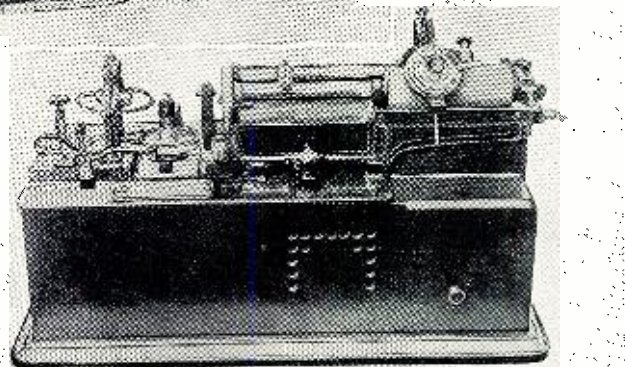

Fig. 13. First Edison model which used the dual sapphire styli or single reproducer.





TV TUBES  
RADIO  
WHAT TO BUY  
DYNAMIC  
New  
HIGH FIDELITY FOR LESS

# Sales Aids

### PACKAGE-DISPLAY UNIT

JFD Manufacturing Company, Inc., 6101 —16th Ave., Brooklyn 4, N. Y.,

has developed an arresting new package for its "Venus Indoor Antenna" line, Models TA141 and TA144.



The package embodies a fashion model's eye against a colorful striped pattern alternating on a silver or gold foil. The carton houses ten of these separate packages and can be opened by means of a tear tape and then

converted into a display stand which will hold the "Venus" packages on top.

The antenna itself is available in mahogany, ebony, or ivory.

\* \* \*

### TACO WALL BANNER

Technical Appliance Corporation of Sherburne, N. Y. is making it possible for its dealers to tie-in with the firm's national advertising campaign by offering colorful wall banners measuring 2 feet by 3 feet. Carrying out the same design which appears in Taco advertising, the banner is an attractive pro-

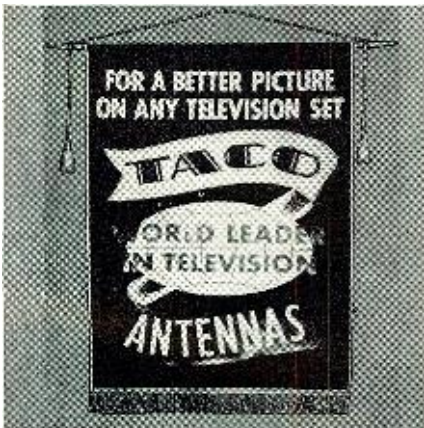

motional piece carrying the message "For a better picture on any television set—Taco (World Leader in Television) Antennas."

\* \* \*

### SYLVANIA AD CAMPAIGN

A double-barreled outdoor advertising program for the company's TV dealers has been announced by the Radio and Television Division of Sylvania Electric Products Inc.

The program has two parts. To a large-size permanent highway "spectacular" display program now under-

# THE NEW RADIO Handbook 14th EDITION

# RADIO Handbook

The very latest publication of the world famous Radio Handbook with . . . ALL NEW EQUIPMENT SHOWN!

A wealth of valuable reference work will be found in these profusely illustrated and diagrammed 768 pages.

Chapter after chapter of necessary, vital information for every practical radioman, technician, advanced amateur, engineer and operator.

### Just look at these chapter titles!

- Introduction
- Oscilloscopes
- Power Supplies
- Test Equipment
- V.T. Principles
- Semi-Conductors
- V.T. Amplifiers
- FM Transmission
- Mobile Equipment
- D-C & A-C Circuits
- Transmitter Design
- Transmitter Keying
- Workshop Practices
- Transmitter Constr.
- R-F V.T. Amplifiers
- S.S.B. Transmission
- Amplitude Modulation
- Receiving Equipment
- TV & BC Interference
- Special V.T. Circuits
- Receiver Fundamentals
- Antennas, H-F, V-H-F, U-H-F & Beams
- Speech & AM Equipment
- Radiation, Propagation & Transmission Lines
- Exciters & Low Power H-F Ampl.
- R-F Energy Generation

**\$7.50** in U.S.A.  
(plus sales tax)



### BUY FROM YOUR FAVORITE DISTRIBUTOR

at above price or add 10% on direct mail orders to:

EDITORS and ENGINEERS, Ltd.

SUMMERLAND 2, CALIFORNIA

BOOKSTORES: ORDER FROM BAKER & TAYLOR CO., HILLSIDE, N.J.

### SOLE CONSTANT-VOLTAGE TRANSFORMER

Ends fluctuating line voltage!

**OVER 60% OFF...**

the factory price at a 1-input 2,000 VA unit! And here's another bonus! This Air Forces 2,000 VA overstock. Sola Cat. No. 30768, has 4 inputs! 90-125 V., 190-250 V., 60 cy. or 50 cy. Isolated secondary is constant 115.0 V. ± 1% from no-load to full-load of 17.4 amp. So, if you choose, use it as a 220:115 V. step-down. And slash \$147.50 off the factory 1-input price!

Brand new in original wood box, 4 cu. ft. Ship. wt. 254 lbs. F.O.B. Pasco, Wash. Only **\$97.50**

(EXPORTERS: Note choice of 50 cycles.)  
**THE M. R. COMPANY**  
P. O. Box 1220-A Beverly Hills, Calif.



### LEARN TV SERVICING UHF—COLOR—VHF

Master the latest, up-to-the-minute TV and Color TV developments.

You can Earn to \$5,000-\$10,000 a year in TV servicing after a few short months. Education or age is no barrier. Find out how you can EARN WHILE YOU LEARN in our big Shops and Laboratories. You work with the latest equipment. Waste no time with Non-Essentials, Math or Design Theory. Complete information in our new FREE booklet. Address I-56-R, R115. Approved for veterans. Free Placement Service.

**WESTERN TELEVISION INSTITUTE**  
341 W. 18th St. Los Angeles, Calif.

Dept. I-56-R  
Mail me information about training.  
Name .....  
Address .....



**A**.... Always  
**B**.... Buy  
**C**.... Columbia

★ ★ ★ ★ ★ ★ ★ ★ ★ ★

**Brand new! ARC-4 Not Used!**

Gleaming, beaming, spanking new! Shiny, sharp and downright terrific! Sensational remote, mobile, or fixed installation. SEE NOV./55 C.O. PAGES 40-43 FOR COMPLETE EASY-TO-DIG CONVERSION WRITE-UP FOR 2 METERS. We bought 'em surplus and we're selling them at out-they-ro-prices! Pick your favorite deal:

**DEAL NUMBER ONE:** ARC-4 Transceiver complete with all tubes, remote control box, junction box fuse block. . . . . \$27.95

**DEAL NUMBER TWO:** ARC-4 TRANSCEIVER as above BUT PLUS a shock-mounted rack with plug for mobile. All new. . . . . \$34.95

**DEAL NUMBER THREE:** ARC-4 Transceiver as above, No. 2 BUT PLUS a 2 VDC mobile plug-in dynamotor. . . . . \$37.95

**DEAL NUMBER FOUR:** ARC-4 TRANSCEIVER same as No. 2 BUT PLUS AC power supply kit delivering 385 VDC @ 300 MA and 12 V filament. . . . . \$49.95

**AC POWER SUPPLY KIT** for above, alone. . . . . \$9.95

**SHOCK-MOUNTED RACK** for above, with plug. New. . . . . \$1.95

**12 VDC PLUG-IN MOBILE DYNAMOTOR.** For above. . . . . \$9.50

**OIL CAPACITORS! ALL BRAND NEW!**

MFD	VVDC	PRICE	MFD	VVDC	PRICE
400	.10	30	600	1.95	
400	1.95	42	600	2.95	
500	.30	1	1,000	1.49	
600	.29	2	1,000	.49	
600	.35	8	1,000	1.49	
600	.39	15	1,000	2.49	
600	.49	5	1,500	.49	
600	.59	1	1,500	.69	
7.5	600	8	1,500	1.95	
10	600	.89	5	2,500	.35
			5	7,500	3.95

**A COUPLE OF MIKES YOU'LL LIKE!**

**"SURE" CONTROLLED RELUCTANCE RECORDING MIKE** @ \$15.00. Brand new. Your cost. Only. . . . . \$4.95

**ELECTROVOICE #912 CRYSTAL MIKE.** Brand new. Only. . . . . \$5.95

**PLATE MODULATOR**

MD-7/ARC-5. These units use 1625's in push-pull modulation. May be used to modulate any rig with 807's push-pull finals. Excellent Condition. . . . . \$4.95

Brand New in Orig. Box. . . . . 7.95

**SCOOP OF THE YEAR!**

RCA MODEL 630 TV POWER TRANSFORMER. 73 V. @ 30 MA. 6.3 V. @ 10 A. 5 V. @ 6 A. And 5 V. @ 2 A. High volt. insulated. For use in 30-tube TV receiver. New in original RCA carton. Ea. . . . . \$5.95

**Command Gear @ Command Prices!**

All complete with tubes!

5.3-7 MC. Xmtr. Used, excelent. . . . . \$ 2.95

3-4 MC. Xmtr. Brand new. . . . . 14.95

7-9.1 MC. Xmtr. New. Boxed. . . . . 5.95

T-23/ARC-5 VHF Xmtr. with tubes. . . . . 4.95

19-55 MC. Q 5'er. Excellent. . . . . 2.95

3-6 MC. Recv'r. Used, excel. . . . . 3.95

3-4 MC. Xmtr. Used, excel. . . . . 7.95

**COMPLETE 50 FT. ANTENNA MAST**

4" O.D. Hollow center to provide for coax lead of rotor shaft. Dis-assembled it collapses to five 11 ft. sections. Comp. with all hardware, base, top, corkscrew guy anchors, ground stake. New in oversize crate. 4 of the make terrific rhombic antenna. Package deal: 4 units for \$69.95. Truck shipment only. . . . . \$19.95

Each . . . . .

**40 METER PACKAGE DEAL**

1 ea. excel. cond. 6-9.1 Receiver

1 ea. new, boxed 7-9.1 MC Transmitter

1 ea. excel. cond. MD-7/ARC5 Plat Modulator. With all tubes!

Regular value \$21.85

**SPECIAL PRICE ALL 3 UNITS.. \$14.95**

**COILED MIKE CORD**

More stretch than a rubber check! Collapses to 24 inches and extends to 11 feet!

New. 3 for \$2.00. Each. . . . . 79c

**FILTER CHOKE SPECIALS**

COLLINS 6 Hy. @ 150 MA. Ea. . . . . 95c

THORNTON 15 Hy. @ 200 MA. . . . . 1.49

Ea. . . . . \$1.49

G.E. 800 Hy. @ 2 MA. Ea. . . . . 49c

2 Hy. @ 100 MA. Ea. 39c; 3 for. . . . . \$1.00

**ASK FOR NEW FREE CATALOGUE!**

All orders FOB Los Angeles. 25% deposit required. All items subject to prior sale. MIN. ORDER \$3.00.

**OPEN FRIDAY NITE TILL 10 P.M.**

**Columbia ELECTRONICS**  
 2251 W. WASHINGTON BLVD.  
 LOS ANGELES 18, CALIFORNIA

way in many states, the division has added a low-cost program of smaller signs. Both utilize reflectorized material for maximum visibility in automobile headlights at night. Both types avoid the common rectangular shape of most billboards.

Although the program is designed specifically for the suburban and small town dealer, it will benefit all dealers in the territory. Distributors and dealers may select the type of signs, location, and message. The displays are available to dealers on a cooperating basis.

**FRAMED DISPLAY UNITS**

Woodall Industries Inc. of California, 1970 Carroll Ave., San Francisco, Calif., is now offering a new line of

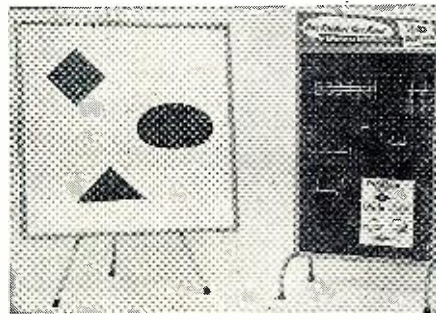

portable displays which are available in a choice of types and sizes.

Identified as the "3-D Display," units are made of perforated hardboard framed with lightweight steel tubing. Panels are of regular 3/16" "Perforal" stock, drilled on 1" centers, which can be used in their natural dark finish or painted any desired color. A variety of standard hooks and holders suitable for literature and product display are available.

Information on the sizes and types of displays currently stocked is available from the manufacturer.

**PILOT BANNER**

Pilot Radio Corporation, 37-06 Thirty-Sixth Street, Long Island City 1, N. Y., is now offering a handsome royal blue satin banner with gold letters, fringe, and tassels which measures 31" x 21".

The banner copy reads: "High Fidelity by Pilot. Designed to Professional Standards for the Home".

Each banner is individually packaged and is available to Pilot dealers upon request.

**ANTENNA CALCULATOR**

A compact, rotary slide chart which facilitates the computations involved in antenna design and application is now available from the Electronics Division of The Gabriel Company, Needham Heights, Mass.

One calculator scale provides for quick conversion between frequency and wavelength in both centimeters and inches. Another shows relation of power gain and db gain. Other scales give the relationship of wavelength, gain, and beam width to reflector diameter for parabolic reflectors from 4 inches to 100 feet in diameter.

**TELEVISION CAMERA**  
**R.C.A.! New! Surplus! Only \$197.50**

for Labs!  
 Export!  
 Industrial!  
 Medicine!  
 Closed Circuit  
 TV!

**COMPLETE WITH ICONOSCOPE & F4:5 LENS**

Labs, hobbyists, industries, TV technicians—set up your own telecast system! It's a "mechanical eye" for factories, prisons, swim pools, closed circuit TV—100's other uses! Iconoscope, 6-stage video amplifier and clipper. View pilots, movies on closed circuit! Write for complete technical data.

**LOUDSPEAKER CARRIER CONTROL**

Type 3A. Mfg. by LANGEVIN. A real \$150.00 value. Brand new. . . . . \$14.95

RC-435 COMPASS RECEIVER. 12 V. Excell. Cond. . . . . \$24.95

**SPECIAL! LZ "S" BAND TEST SET!**

Complete with tubes and meter. Excellent condition. Worth three times the price! . . . . . \$99.50

**NEW 24 V TRANSFORMER & RECTIFIER COMB.** a basic 24V. DC power supply of 110V AC primary. 24V secondary and Rectox Rectifier. Operates intermittently up to 1 or 2 amps. Ship. wt. 3 lbs. With instruction data. . . . . \$2.95

**HEAVY DUTY MOBILE ANTENNA MOUNT**

Rugged as a rock! Ideal for home, vertical, mobile, marine. E'cast or commercial installation. Unbreakable bakelite base. Single hole mounting. Spring height 6 3/4"; diam. 2 1/2". Overall height. 11". Ship. wt. 10 lbs. New in orig. box. A \$15.00 value. Only. . . . . \$2.95

**T-222 SIGNAL GENERATOR-MICROVOLT**

Freq. range: 8-15 Mc. & 150-280 MC. Complete with all tubes and 5 MC Calibrating Crystal. Self-contained 110 V. and 60 cycle power supply. With Schematic. Excellent cond. Cost the Govt. approx. \$3995

\$700.00. ONLY. . . . .

**STOP & SWAP!** We buy items! What have you?

25% deposit on all C.O.D. Min. order \$3.00

All items F.O.B. Wholesale. Subject to prior sale and change of price without notice. GET FREE CATALOG!

**Harjo Sales Co.**

Office-Warehouse: Dept. R-1, 503 N. VICTORY BLVD., BURBANK, CALIF.

*High Fidelity Magic...*

from **TEICO**

**KIT \$49.95**  
 Factory Wired \$79.95

**NEW! 20-WATT HIGH FIDELITY AMPLIFIER #HF20**

Due to its Ultra-Linear output stage with its conservatively-rated Ultra-Linear output transformer, the #20 features negligible distortion & increased power-handling capacity at both extremes of the audio spectrum. Costliest, complete equalization facilities—plus low-distortion, wide-range tone controls & Centralab Compentrol loudness control—create a preamplifier and control section unsurpassed even in units ticketed at much higher prices.

- Power Response (20W): ±0.5 db 20-20,000 cps; ±1.5 db 10-40,000 cps.
- Frequency Response (1/4W): ±0.5 db 13-35,000 cps; ±1.5 db 7-50,000 cps.
- Rated Power Output: 20 w (34 w peak).
- IM Distortion: (60 cps) 6 kc/4:1) at rated power: 1.3%.
- Mid-Band Harmonic Distortion at rated power: 0.3%.
- Maximum Harmonic Distortion (between 20 & 20,000 cps at 1 db under rated power): approx 1%.
- Speaker Connection Taps: 4, 8 & 16 ohms.
- High quality preamp-equalizer & control section plus complete 20-watt Ultra-Linear Williamson-type power amplifier. Output transformer in compound-filled seamless steel case.

See and HEAR it at your neighborhood distributor. Write for FREE Catalog RA-1

**TEICO** 84 Withers St., Brooklyn 11, N. Y.  
 Prices 5% higher on West coast



The reverse side of the calculator is designed to aid in the selection of antennas for use in various microwave bands.

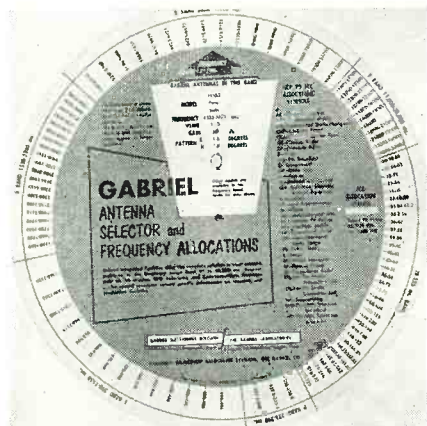

The calculator is printed in three colors on heavy card stock that will withstand repeated usage. Requests for the calculator should be addressed to Mr. A. Murphy of the company.

**G-C-STACKPOLE DISPLAY**

G-C Electronics Mfg. Co., a division of General Cement Mfg. Co., 400 S. Wyman St., Rockford, Ill., and Stackpole Carbon Co. are now offering a comprehensive line of carbon resistors in color-coded hinged cover plastic boxes.

Designed to make it easy for service technicians to select the resistors they need on a self-service basis, the new "G-C 60 Line" is uniformly priced with



six, four, or three resistors to the box. The large self-service display rack holds 77 different RETMA values of resistors.

**JENSEN PROMOTION PACKAGE**

Jensen Manufacturing Co., 6601 S. Laramie Ave., Chicago, Ill., has teed off with a hard-hitting promotional campaign to market its line of "TV Duette" speaker systems for improving sound from television receivers.

The campaign includes newspaper advertising mats, spot announcements for radio and television, consumer flyers and brochures, mailing pieces, window banners, and point-of-sale displays.

The entire campaign is offered as a package to dealers who should contact

# LOOK FOR THIS LABEL

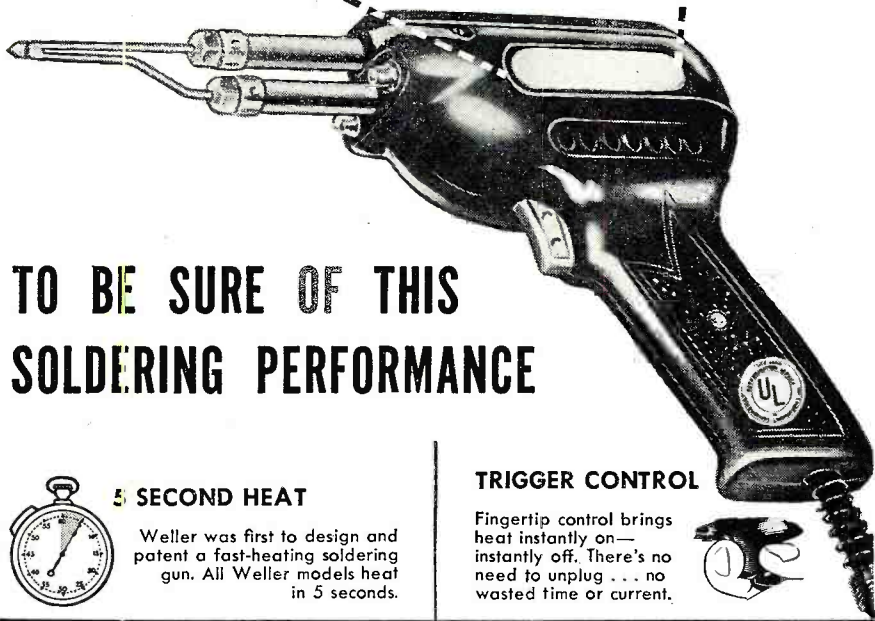

## TO BE SURE OF THIS SOLDERING PERFORMANCE



**5 SECOND HEAT**

Weller was first to design and patent a fast-heating soldering gun. All Weller models heat in 5 seconds.

**TRIGGER CONTROL**

Fingertip control brings heat instantly on— instantly off. There's no need to unplug . . . no wasted time or current.



**PERFECT BALANCE**

The exclusive streamlined design of Weller Guns permits easy access to tight places, comfortable handling and precision soldering.

**EXCLUSIVE TIP-GRIP**

Wiping action of tip-fastening nuts eliminates contact resistance and oxidation. Full, constant heat is assured.



**2 SPOTLIGHTS**

Pre-focused dual spotlights eliminate shadows and illuminate the work. Lights and heat come on simultaneously.

**LONG-LIFE TIPS**

Low cost Wellertips give long service, are designed for maximum heat transfer and can be changed in seconds.



ask your distributor for a demonstration

**ELECTRIC CORP.**

810 Packer Street, Easton, Pa.

**THE NEW**

## No-Noise TUNER TONIC

Volume Control and Contact Restorer with Perma-Film



Cleans, lubricates, protects . . . not a carbon-tet solution. Still available in the new 6 oz. spray can. Net to servicemen—\$2.25

2 oz. bottle. Net to servicemen **1.00**



Also available in 8 oz. bottles and quart cans. At your nearest distributor.

with **PERMA-FILM**

Cleans, lubricates, restores all tuners including wafer type. Won't change or affect capacitors, inductance or resistance. Won't harm insulations or precious metals, nor attack plastics. For television, radio and FM. Eliminates all noise, oxidation and dirt indefinitely.

Non-toxic. Net to servicemen. **\$3.25**

Extra economical because a small amount does the job!



**ELECTRONIC CHEMICAL CORP.**

813 Communipaw Avenue

Jersey City 4, N. J.



# LOWEST PRICES MONEY BACK GUARANTEE

**KW PLATE TRANSFORMER**  
4700 Volts CT @ 350 mills. Pri. 115 V \$60 cy. Made by CHICAGO TRANS. CO. Fully shielded, type F5 case. . . . . \$21.95

**H.D. FILTER CHOKES**  
5 Henry 400 ma, 10 KV ins. Full case. . . \$ 4.95  
19 Henry 1.2 amp, 12.5 KV ins. Full case. . . 19.95

**H.V. POWER SUPPLY KIT**  
Transformer and 2 400 ma chokes described above plus 2 2 mfd 4000 volt oil condensers. . . \$32.95

**2 Mfd 4000 VDC** Oil Condenser Ceramic Ins. \$2.95 ea. 2 for \$5.90  
**1 1/2 INCH SQUARE METER** 0-500 microamps, high accuracy. . . . . \$3.95

**STANDARD POWER TRANSFORMER**  
1000 Volt CT at 230 ma, 6.3 volt at 4 amp, 8.3 volt at 3 amp, 5 volt 3 amp. Pri. 110 volt, 60 cy. Full case. Brand New. Price. . . . . \$4.95  
2 for \$8.95

**WESTERN ELECTRIC**  
4 quadrant phase shift capacitor. . . \$14.75  
D150734. . .

**FILAMENT TRANS.**  
6.3 Volts @ 8 Amp & 6.3 Volts @ 1 amp, 110 V. 60 cycle Pri. \$1.39

**1" Millimeter**  
Mounts into 1" hole. 10 mill basic, easily shunted to other ranges. Free shunt wire. Your choice 0-10 ma \$3.95  
5-0.5 ma.

**1" Microometer**  
0-200 microamps. Same type as 1" millimeter. Mounted in rubber casing which may be removed if desired. \$5.95

**H. D. 12 VOLT DYNAMOTOR**  
500 volts output at 400 ma. Mounted on filter base with fuses, starting relay, etc. Has switch for 24 volt operation also. DM49AX. Brand New. . . . . \$17.95

**12-14 VOLT DYNAMOTOR**  
375 Volt at 250 Ma. In Case with Filter. . . \$7.75

**MALLORY VIBROPACK**  
12 Volt Input. 200 Volt Out. Small Size \$4.95

**MOBILE DYNAMOTORS**

OUTPUT	INT. DUTY	5.5 to 6 VOLT DC INPUT	CONTR. DUTY	FILTER*	PRICE
400 VDC	275 Mills	175 Mills	with	\$19.95	
400 VDC	200 Mills	100 Mills	less	12.95	
425 VDC	375 Mills	275 Mills	less	24.50	
<b>11.5 to 12 VOLT DC INPUT</b>					
400 VDC	275 Mills	175 Mills	with	12.95	
625 VDC	225 Mills	175 Mills	less	11.75	

**PANEL METERS**  
WESTON, G.E., SIMPSON, etc.

2" METERS		3" METERS	
0-100 Microamp. . . \$5.95	0-1.5 Milliamp. . . \$2.95	0-100 Microamp. . . 4.95	0-1.5 Milliamp. . . 2.95
0-150 Microamp. . . 4.50	0-150 Milliamp. . . 3.95	0-150 Microamp. . . 4.50	0-200 Milliamp. . . 3.95
0-4 Amp RF. . . . . 2.95	0-200 Milliamp. . . 3.95	0-1 Milliamp. . . . . 3.95	0-300 Milliamp. . . 3.95
0-1.5 Milliamp. . . 2.95	0-500 Milliamp. . . 3.95	0-5 Milliamp. . . . . 2.95	0-150 Volts AC. . . 4.95
10-0-10 Amp DC. . . 2.95	0-150 Volts AC. . . 4.95	DB 0 to +15. . . . . 2.95	0-15 Amps DC. . . . 2.95
0-300 Volt AC. . . . 3.95			

**OIL CONDENSER BARGAINS**

1 mfd 600 VDC \$ .25	6 mfd 1500 vdc. \$1.95
2 mfd 600 VDC .45	10 mfd 1400 vdc. 2.50
4 mfd 600 vdc. .75	2 mfd 2000 vdc. 1.50
8 mfd 600 vdc. .95	3 mfd 2000 vdc. 2.25
10 mfd 600 vdc. .99	4 mfd 2000 vdc. 2.95
1 mfd 1000 vdc. .60	1 mfd 3000 vdc. 1.85
2 mfd 1000 vdc. .75	3 mfd 4000 vdc. 4.95
2 mfd 1000 vdc. 1.25	8 mfd 600 vac. 1.35
8 mfd 1000 vdc. 1.35	

**G. E. RELAY CONTROL**  
(Ideal for Model Controls, Etc.)  
Contains a sigma midget 8,000 ohm, relay (trips at less than 2 MA), high impedance choke, bimetal strip, neon pilot and many useful parts. This sensitive relay alone is worth more than the total low price of. . . . . \$1.25 Each 10 for \$9.90  
FREE Model Control Book with Purchase of 10.

**COAX ANTENNA SWITCH**  
RF relay with low loss ins. Switches to either of 2 coax receptacles. Latching device removes voltage after actuated, permitting operation from 12 volt DC to 115 AC. Mounted in aluminum case. . . . . \$1.95  
2 for \$3.50

**BIG BARGAINS IN LITTLE TYPE**  
Kit of 25 WIRE WOUND RES. 5 to 50 watt. \$1.95  
Kit of 10 TRANSMITTING MICA. . . . . 1.95  
9 Ohm 100 watt Non-inductive resistors. 6 for 1.45  
.01 1000 VDC xmitting mica cond. . . . . 5 for .95  
100,000 ohm, 100 watt biester res. . . . . 2 for .99  
.0004 2500 V DC MICAS 10. . . . . .99  
500 MMF CERAMIC CONDENSERS. . . . . 10 for .50  
6-12 VOLT DC RELAY DPDT. . . . . .79  
JENNINGS Vacuum Cond. 12 MMF 20 KVDC. 5.95  
MN26 Direction Finder, LIKE NEW with tubes. 12.95  
FLS RANGE FILTER. . . . . .69  
15 MEG 1% METER MULTIPLIER. . . . . 1.49  
ADVANCE HER. SEAL OCTAL PLUG-IN RELAY, 10,000 OHM COIL, 3MA. . . . . 1.95  
1 MFD 400VDC OIL COND. . . . . 10 for .95

Min. Order \$3.00—25% with order F.O.B. New York 10 DAY GUAR. PRICE OF MDSE. ONLY

**POST ELECTRONICS COMPANY**  
69 BARCLAY STREET, NEW YORK 7, N. Y.  
Phone WOrth 4-2526

their local distributors or write the company direct.

**PISTON CAPACITOR KITS**  
JFD Electronics, a division of JFD Manufacturing Company, Inc., 6101 16th Ave., Brooklyn 4, N. Y., is now offering a new piston capacitor kit, PK85, which provides a comprehensive selection of the units for electronic experimental purposes. The kit houses

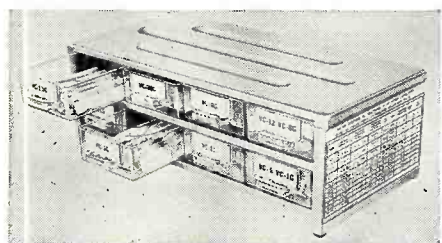

an assortment of 85 quartz and glass piston capacitors of the 10 basic types now in use.

All of the capacitors in the kit are individually packaged, affording positive protection and easy selection. A rugged, compact metal cabinet, with a double row of compartment drawers, holds the assortment.

**SOLDERING TIP ASSORTMENT**  
Electric Soldering Iron Co., Inc. of Deep River, Conn., is now offering a complete assortment of its new gun-type soldering tips mounted on an attractive counter card.

The varied sizes and shapes, including long and short, narrow and broad, straight and curved, are included in this new assortment. Included are tips for soldering connections to small prongs and for thin channel-type lug connections to make the technician's job simpler and faster.

Write the manufacturer for full details on the line and its display card.

**BATTERY MERCHANDISER**  
Franklin Manufacturing Company of Minneapolis, Minn., has recently introduced a new battery merchandiser which is designed to increase the dealer's battery sales.

The Model 154A "Speed-O-Matic" tester-charger, for both 6 and 12 volt batteries, provides five different bat-



tery tests to positively identify battery trouble. A built-in "battery protector" makes fast recharging safe.

# MODEL PRECISION 6 2 RELIABLE TUBE TESTING AT MODERATE COST

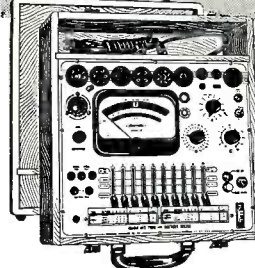

Employs popular RETMA emission type circuit

- ★ Tests All Modern Tube Types - Fil. Voltages 3/4 to 117 volts.
- ★ Built-in 7 & 9 Pin Straighteners.

- ★ Absolute Free-Point 10 element lever selection.
- ★ Dual Short-Check Sensitivity. ★ Ballast Unit Tests.
- ★ Tests Each Section of Multi-Section Tubes.
- ★ Noise and Condenser Test pin jacks.
- ★ Hi-Speed Roll Chart ★ Micro-Line Adjustment.
- ★ 5 1/4" PACE Meter, 2% Accuracy.
- ★ Dynamic "Under-Load" Test for all popular radio A, B, and C dry batteries.

Model 612-P Deluxe: (Illustrated) Modern 2 color satin brushed aluminum panel. Rubbed natural finish, hardwood cabinet. . . . . Net Price: \$89.50  
Model 612-P Standard. . . . . Net Price: \$84.50

PRECISION Test Equipment is available and on display at leading electronic parts distributors. Ask for latest complete catalog.

**Precision Apparatus Co., Inc.**  
70-31 84th STREET • GLENDALE 27, L. I., N. Y.  
Export: 458 B'way, N.Y.C., U.S.A. Cables: MORHANEX  
In Canada: Atlas Radio Corp. Ltd., Toronto 10, Ontario

# ELECTRIC BRAIN KIT

Can you think faster than this Machine?

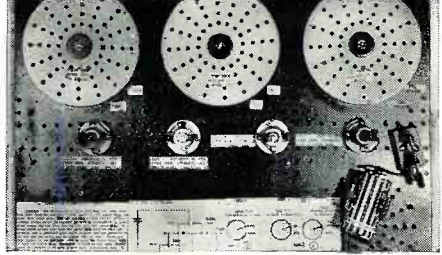

Control Panel of GENIAC set up to do a problem in check valve research.

Be careful before you answer. GENIAC the first electrical brain construction kit is equipped to play tic-tac-toe, cipher and encipher codes, convert from binary to decimal, reason (in syllogisms) as well as add, subtract, multiply and divide. Specific problems in a variety of fields—actuarial, policy claim settlement, physics, etc., can be set up and solved with the components. Connections are solderless and are completely explained with templates in the manual. This covers 33 circuits and shows how new ones can be designed.

You will find building and using GENIACS a wonderful experience: one kit user wrote us: "this kit has opened up a new world of thinking to me." You actually see how computing, problem solving, and game play (tic-tac-toe, nim, etc.) can be analyzed with Boolean Algebra and the algebraic solutions transformed directly into circuit diagrams. You create from over 400 specially designed and manufactured components a machine that solves problems faster than you can express them.

Schools and colleges, teachers of science or math, engineering, philosophy or psychology will find these excellent demonstrators of circuitry, solutions in symbolic logic, theory of numbers, cybernetics, and automation.

Note: Teachers take advantage of our 10% discount to educational institutions and for group purchases. SEND for your GENIAC kit now. Only \$19.95 with over four hundred components and parts, fully illustrated manual and wiring diagrams. We guarantee that if you do not want to keep GENIAC after one week you can return it for full refund plus shipping costs.

----- MAIL THIS COUPON -----

**SCIENCE KITS, Dept. RT-1, Oliver Garfield Co.**  
126 Lexington Ave., N.Y. 16, N.Y.

Please send me:  
1 GENIAC Electric Brain Construction Kit and Manual.  
\$19.95 (East of Mississippi) . . . . .  
\$20.95 (Elsewhere in United States) . . . . .  
\$21.95 (Outside the United States) . . . . .

Returnable in seven days for full refund if not satisfied. I enclose \$ . . . . . in full payment. My name and address are attached.

**RADIO & TELEVISION NEWS**



**Choosing a Phono Pickup**  
(Continued from page 39)

and will be discussed in another article. If the stylus point tends to ride up the walls of the groove at any modulation frequency in the audio band, it is said to be failing to track at that frequency. This means that a greater pressure is required on the stylus to force it down into the groove and avoid this cause of distortion.

The principal way in which a pickup can be made to follow the groove more readily with less stylus force is by increasing the compliance in the stylus movement. Compliance is that quality which is opposed to the quality known as stiffness, thus, as the movement becomes less stiff it becomes more compliant. Obviously compliance is a matter that must be considered in conjunction with the ruggedness of the pickup, because the stylus has to maintain its correct operating position in the middle of its travel, otherwise it will run into distortion troubles.

This means that every part of a pickup, including the arm in which it is mounted, must have extremely free movement if the best use is to be made of a high compliance. Thus we might say that the higher the stylus compliance, the less will be the record wear that the pickup produces. While this is true in principle, there are other factors that go along with compliance, which we will discuss in a moment.

Undoubtedly the best pickup for minimizing record wear is the *Weather's* which was mentioned earlier. It has a lateral compliance of  $14 \times 10^{-6}$  centimeters per dyne, which is much higher than for any other pickup on the market, and it will track with an effective stylus force of 1 gram, which is not more than half that required for the next best type of pickup.

Its disadvantage, as already mentioned, is that performance depends on accurate maintenance of the oscillator/FM part of the equipment. Most people prefer a pickup which gives an audio output direct, so that, if the pickup is mechanically sound, there is nothing else to worry about. However, if you are a perfectionist, and are prepared to go to some trouble with maintenance to keep your record wear to an absolute minimum and distortion low, you may well choose this pickup.

**Design Features**

A few words here about the general principles in the mechanical design of pickup movements. The best design is a compact one, in which the whole moving mechanism is of the simplest and most "streamlined" shape possible. Try to think of the moving mechanism vibrating in as many different modes as you can imagine. The more complicated its shape, the more complicated the possible modes in which the mechanism could vibrate, and each of these will produce variations in the frequency response in the form of resonances.

*Here's proof of McIntosh's superior performance!*

For clean amplification, low distortion and abundant power no other amplifier compares with the McIntosh—long the standard of high fidelity excellence. The fundamentally-different McIntosh circuit delivers amplification within 0.4% of theoretical perfection! The result: outstanding realism, clarity and listening quality. Make the McIntosh listening test at your dealer's.

Distortion: 1/3% Harmonic and 1/2% IM, even at full rated output, from 20 to 20,000 c.p.s. Power: 30 watts continuous, 60 watts peak (for Model MC-30); 60 watts continuous, 120 watts peak (for Model MC-60). Frequency Response: 20 to 20,000 c.p.s.  $\pm 0.1$  db at full rated output. Highest efficiency means longer life.

Outstanding Performance of the McIntosh Patented Circuit

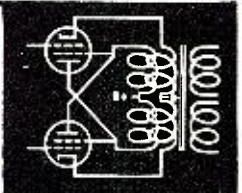
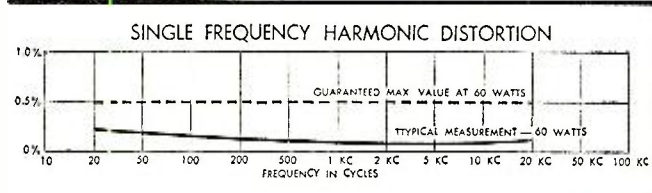
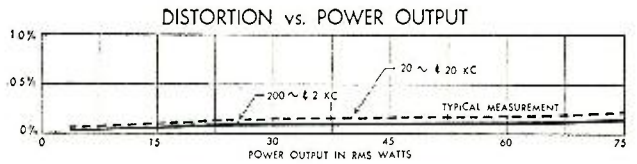

Write for complete details on McIntosh amplifiers and free booklet.

**McIntosh**  
LABORATORY, Inc.

326 WATER ST., BINGHAMTON, N. Y.  
Export Div. 25 Warren St., N. Y. 17 Cable: Simontrice



MC-60 \$198.50

**SAVE \$\$\$**  
**THOUSANDS OF BARGAINS**  
Send Stamp for our  
**GIANT CATALOG**  
UNITED RADIO CO.  
58A MARKET ST. NEWARK, N. J.

**RADIO and TELEVISION ELECTRONICS**  
in all Technical Phases  
New Classes (Day and Evening) Start 1st of Dec., Mar., June, Sept.  
Free Placement Service for Graduates  
For Free Catalog write Dept. RN56  
**RCA INSTITUTES, INC.**  
A Service of Radio Corporation of America  
350 WEST 4TH ST., NEW YORK 14, N. Y.

**stop knockin' yourself out!**  
let the **MASTER** make life easier for you... see pg. 137

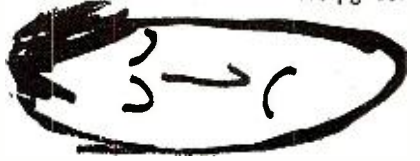



# AMATEUR CRYSTAL HEADQUARTERS

FOR THE MAN WHO WANTS  
**A Rugged Crystal**

We have the DC-34 holder you can use with a 1/2" adapter—man! what output—a big 1/2" piece of quartz that really oscillates—ground by skilled craftsmen and counted to your exact frequency by our electronic counter.

NOVICE BANDS **79c**  
IN 1 KC STEPS  
DC-34 OR FT-243 EACH

6-10-20-40-80 METER  
HAM BANDS IN DC-34  
OR FT-243 **79c**

STOCK XTALS  
FT-241  
FT-243  
DC-34  
FT-171 **50c**  
EACH

Send postcard for free list  
of frequencies.

## DC-34 HOLDERS

1690	2175	2360	2685	3000	3412	3790	4030	4275
1705	2195	2375	2710	3010	3422.5	3792	4035	4305
1720	2202	2390	2711	3023	3452	3825	4065	4310
1770	2215	2395	2732	3027	3480	3830	4065	4325
1790	2220	2415	2745	3055	3520	3855	4085	4345
1810	2235	2422	2775	3095	3540	3870	4095	4350
1830	2240	2435	2807	3117	3575	3885	4115	4370
1850	2255	2466	2816	3149	3580	3895	4130	4380
1870	2258	2467	2831	3161	3610	3905	4135	4397
2050	2260	2491	2851	3190	3630	3925	4150	4405
2065	2275	2514	2863	3279	3655	3935	4155	4415
2082	2280	2527	2894	3280	3665	3945	4175	4435
2090	2282	2540	2899	3311	3695	3950	4177	4440
2105	2295	2559	2925	3317	3702	3965	4192	
2106	2300	2587	2926	3345	3705	3988	4210	
2142	2326	2605	2960	3365	3745	3995	4215	
2155	2335	2625	2971	3385	3765	4012	4235	
2174	2355	2643	2980	3395	3775	4015	4255	

FT-243 HOLDERS **50c**  
5675KC-8650KC IN 25KC STEPS

FT-241 LATTICE XTALS **50c**  
ALL FREQ. FROM 370-540KC  
500KC CRYSTALS \$1.00

# TEXAS CRYSTALS

"The biggest buy in the U. S."

P. O. BOX 1912, DEPT. R  
FORT WORTH, TEXAS

TERMS: All items subject to prior sale and change of price without notice. ALL crystal orders MUST be accompanied by check, cash or M. O. WITH PAYMENT IN FULL. NO C.O.D. Postpaid shipments made in U. S. and possessions only. Add 5c per crystal for postage and handling charge.

The stylus must be rigidly mounted to the armature, or moving coil, or whatever element forms the transducer and any damping, using blocks of rubber or other special material, must be mounted in such a manner that the damping controls the resonance of the system and does not encourage it to vibrate in some more complicated mode. For instance, damping applied half way back along the stylus arm, in a concentrated lump between the stylus point and the pivot, will tend to hold the point still where the damping is applied, and make the stylus vibrate at its tip and again at the pivot. As output from the pickup is dependent upon the moving mechanism rotating about the pivot, rather than vibrating there, this kind of movement will not result in output and will cause a hole in the response. This is illustrated at Fig. 5. Other kinds of undesired vibration can produce peaks in the response.

A sudden change in the cross-section can also result in undesirable characteristics in the response curve. The cross-section from the stylus tip back to the pivot should increase gradually, and not in any sudden step, and similarly the junction of the stylus with the transducer element should maintain a smooth change in shape and not one that gives sudden steps to the cross-section. All these things can add irregularities to the frequency response.

Assuming that these irregularities are reasonably well eliminated, there are two basic mass components and two compliance components that contribute to the over-all performance: the mass of the tone arm, and the mass of the stylus with its arm, the compliance of the stylus movements, and the compliance of the disc material. Three of these elements are under the control of the pickup and tone arm designers, while the fourth is liable to vary from disc to disc.

The mass of the tone arm in conjunction with the compliance of the cartridge tends to produce a low-frequency resonance. This should be adequately damped, either by damping in the tone arm movement itself, or by care in its construction, or the mass should be adjusted so that the resonance is beyond the low frequency end of the range and not at some frequency where it will emphasize rumble, and other undesirable effects. This

Fig. 5. Effects of poor damping distribution along stylus arm. At (A) damping concentrated midway between the stylus and pivot, accentuates a resonance in the mode shown. The pivot vibrates more than it rotates at this frequency, so the effect will cause a dip in the frequency response. At (B) damping concentrated about one-third of the distance from stylus to pivot will accentuate resonance in a different mode, giving rise to a peak at this frequency, because the damping does not have to move with the stylus arm.

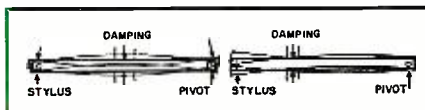

# TUNERS and CONVERTERS



- POLICE - FIRE
- AMATEUR
- CIVIL DEFENSE
- AIRCRAFT

• 110-170 MC  
TUNERS and CONVERTERS  
• 30-50 MC  
net **\$15.95** and up



## 306 B TUNER

• 30-50 meg. band with fixed or variable tuning. Highly stable and sensitive, with exceptional range. Self-contained noise limiter. **\$24.75** net  
6 or 12 volt model.



IMPROVED FM TUNER  
• 88-108 MC  
to plug in your car  
**\$22.50** net

write for literature

Kuhn ELECTRONIC PRODUCTS  
20 Glenwood • Cincinnati 17, Ohio

# TEST and REPAIR

## CRT TUBES

"Right on the Job" with

CENTURY'S CRT  
TESTIVATOR



MODEL No. 103  
Only **\$14.95** Net

New Profits! More Calls! Save Time! Save Trouble! Here is a key to a whole new field of profits for you. With the #103 CRT TESTIVATOR you can repair picture tubes right in the set in a matter of minutes. The TESTIVATOR TELLS YOU INSTANTLY where the trouble is and then fixes it! Here are some of the major advantages of the TESTIVATOR—it TESTS: Cathode emission. Shorts and leakage between elements. Open elements. Probable useful life of the tube. It REPAIRS: Activates the CRT cathode by removing surface contamination. Restores emission giving life to weak and dim tubes. Clears inter-element shorts and leakage. So easy to use . . . you just plug in, attach the TESTIVATOR socket to the base of the CRT and the accurate, easy-to-read indicators tell you what you must know. (Complete instructions with every unit.)

FREE BONUS OFFER—Order your #103 now and receive a handy, valuable booklet listing radio and TV tubes including CRT's which are interchangeable with no wiring changes. Another profit maker for you. Now you can always leave 'em with a picture. The TESTIVATOR IS MONEY BACK GUARANTEED.

## NO RISK TRIAL ORDER COUPON

If Jobber is out of Stock mail order to Century Electronics Co., Dept. RN-1, 111 Roosevelt Ave., Mineola, N. Y. Please send the Model 103 CRT TESTIVATOR on 10 day money-back guarantee. Send Postpaid . . . . . I am enclosing full payment of \$14.95. Send C.O.D. . . . . I will pay \$14.95 plus postage.

Name . . . . .  
Address . . . . .  
City . . . . . State . . . . .  
SAVE! We pay postage on all prepaid orders.



will be more fully discussed when we come to the question of choosing a tone arm.

The mass of the stylus and its arm referred to the stylus point, in conjunction with the compliance of the stylus and the compliance of the disc material, should produce a resonant frequency at least up at the top end of the audio spectrum and preferably beyond it. The damping of the compliance should also prevent the resonance from producing a peak, that is, it should be critically damped, so as to produce a smooth roll-off.

There is the problem of selecting a suitable damping material for a pickup cartridge. Most manufacturers have solved it by using a material that suits their particular design, but the qualities of the material have a time limitation, which means the cartridge has a limited life before its performance begins to deteriorate.

Of course the final judgment of performance will be based on the frequency response of the cartridge and a listening test of the whole equipment. But a general look at the construction provides a good performance criterion.

### Matching Problems

After considering the various pickups on their basic merits, we are still left with the problem as to whether we can match it successfully to our preamplifier.

All ribbon-type pickups and many moving-coil types require a transformer to step the output voltage up to something suitable for amplifying at the grid of the preamplifier input stage, because the impedance of the pickup is so low and its output voltage would be down in the noise unless a transformer were used. In most instances the manufacturer either supplies or recommends a suitable transformer which will serve this purpose. It is essential to consider where the transformer may be placed, as failure to pay careful attention to this can result in serious hum pickup. The transformer must be placed well away from any supply transformers or motor in the equipment and will probably need careful orientation to get a minimum of hum pickup from these components.

All pickups using a transformer will need careful attention to the loading on the secondary of the transformer to avoid a high-frequency resonance due to the transformer itself. This means that the grid resistance of the input stage will need adjusting to get the best over-all response.

The magnetic, or variable reluctance, or moving-iron type cartridge—which ever you prefer to call it—comes in an impedance suitable for the input of the average preamplifier and requires attention only to the necessary loading resistance. If the preamplifier has a resistance across the input of higher value than that specified for the cartridge used, there will be a rise in high frequency. If the value is lower the high frequencies will roll off somewhat. Maybe this can be corrected in

January, 1956

# HOW MUCH DO YOU THINK

## *This Speaker* IS WORTH?

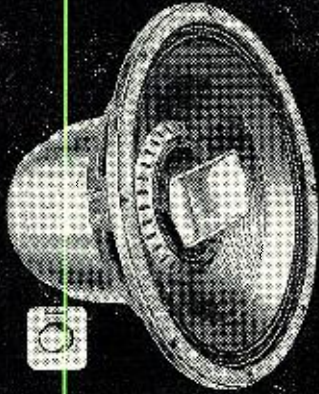

**NOT AN 8" OR 12" BUT A 15"  
TRIAxIAL—UNIVERSITY'S  
NEW, AMAZING 6303!**

**Do you dream of owning a triaxial?... Are they all too expensive for you?** Your dream's come true... at a price you can afford. University has perfected a triaxial masterpiece at a price that will take your breath away!

**Here's the story behind the 6303:** University's first Triaxial (the Super 315) was an immediate sensation. It was (and is) the finest of its kind, though beyond the reach of many. Thanks to the skill gained in perfecting triaxials, we've designed a new speaker having many of the outstanding engineering features of our original triaxial, but—priced so low that

NOW everyone can afford one. *SUCH* a speaker is the 6303.

**Here's the proposition:** Ask to hear it at your favorite dealer. Listen to its magnificent concert-hall realism... to the rich sonorous base, augmented with full bodied mid-range and brilliant super-highs. Admire its superb construction.

NOW... in your mind, think of a price you feel this wonderful speaker is worth. THEN... when you hear the actual price... you will be delightfully surprised.

**For the speaker of your dreams—see and hear the 6303 NOW!**

*University*

LOUDSPEAKERS, INC., 80 So. Kensington Ave., White Plains, N. Y.



Need a Tube Tester?

**FOLLOW THE  
LEADER...**

Buy **EICO**

© 1955

TUBE TESTER #625  
KIT \$34.95 Wired \$49.95



- Tests latest 600 mill series string type tubes.

More Servicemen buy EICO TUBE TESTERS—in KIT and wired form—than any others sold through distributors. Why? Because EICO gives you the MOST value at LOWEST cost.

- Test all conventional & TV tubes and pilot lights.
- 10 individual lever-type element switches.
- Illuminated anti-backlash rollchart kept up-to-date by EICO's Engineering Dept.
- 4½" meter, 3-color "Good-Bad" scale.
- Line-adjust control. Blank socket for new tubes. Protective overload bulb.

In stock at your local jobber. Write for free Catalog RT-1 Prices 5% higher on West Coast.

ELECTRONIC INSTRUMENT CO., INC.  
84 Withers Street • Brooklyn 11, N. Y.

## AUDEL'S TV SERVICE LIBRARY TELLS HOW TO ANSWER RADIO T.V. QUESTIONS

HERE IS LATE INFORMATION IN A HANDY FORM FOR TELEVISION AND RADIO REPAIRMEN, SERVICEMEN AND STUDENTS

**AUDEL'S TV, RADIO SERVICE LIBRARY—** Highly Endorsed—Over 1500 Pages—1048 Illustrations & Diagrams. 1001 Important Facts & Figures on Modern Television, Radio, Electronic Devices at your finger ends.

**INCLUDES TRANSISTORS & Transistor Circuits, Record Changers, Rectifiers, P.A. Systems, Tape Recorders, Phonograph Pick-ups, F.M., Auto Radio; Radio Compass, Short Wave, Radar, etc.**

**ASK TO SEE IT! IT WILL PAY TO KNOW—** The Basic Principles—Construction—Installation—Operation—Repairs—Trouble Shooting. Shows How to get Sharp, Clear T.V. Pictures. Install Aerials—How to Test. Explains Color Systems, Methods of Conversion, Terms, etc. Includes Ultra High Frequency—Valuable for Quick Ready Reference and Home Study.

**6 COMPLETE 2 VOLUMES** Get this Information for Yourself.

**7 DAY TEST—PAY ONLY \$1 A Month**

**MAIL ORDER**

**AUDEL Publishers, 49 W. 23 St., N.Y. 10, N.Y.** Mail AUDEL'S T.V. RADIO SERVICE LIBRARY (2 Volumes) \$6 on 7 days free trial. If O. K. I will remit \$1 in 7 days and \$1 monthly until \$6 is paid. Otherwise I will return them.

Name \_\_\_\_\_  
Address \_\_\_\_\_  
Occupation \_\_\_\_\_  
Employed by \_\_\_\_\_

BN

149



# 100 TUBES \$49.50

**TUBES** PREMIER Unconditionally Guarantees All Tubes For One Full Year Very Best Brands Available For Immediate Delivery, Individually Boxed.

1A5GT	6AL5	6V7	12SN7GT
1A6	6AQ5	6W4GT	12SQ7GT
1A7GT	6AU5GT	6W6GT	12X4
<b>1B3GT</b>	<b>6AU6</b>	6X5GT	12Z3
1B8GT	6AV5	7A5	14B6
1F4	6AV6	7A6	14B8
1FSG	6AX4GT	7A7	14Q7
1H5GT	6AX5GT	7A8	14W7
1H6G	6B4G	7AD7	14X7
1L4	6BA6	7B6	24A
1LA4	6BD6	7B7	25A6
1LA6	6BE6	7B8	25AC5GT
1LCS	6BF6	7C4	25BQ6GT
1LC6	<b>6BG6G</b>	7C5	25C6G
1LD5	<b>6BQ6GT</b>	7C6	25W4GT
1LH4	6C7	7C5	25Y5
1LN5	6BY5G	7E5	25Z5
1N5GT	6C5	7E6	26
1PSGT	6C6GT	7E7	27
1Q5GT	6C6	7I7	32L7GT
1R5	6C8G	7L7	35A/51
1S5	6CB6	7N7	35A5
1T4	6CD6G	7Q7	35C5
1U4	6DE	7V7	35L6GT
1V	6DG	7W7	35Y4
1V4	6EG	7X7	<b>35Z5GT</b>
<b>1X2A</b>	<b>6G6G</b>	<b>12A7</b>	39/44
2A7	<b>6J6</b>	12AU6	41
2X2	6K6	<b>12AU7</b>	42
3A4	6L6G	12AV7	43
3B7	6P5GT	12AX4GT	45
3C6	6Q7GT	45Z5GT	46
3Q4	6S4	12AY7	46
3Q5	6SA7GT	12BA7	47
<b>5U4G</b>	6SD7GT	12BD6	50AX6
5Y3GT	6SF5	12BE6	<b>50L6GT</b>
5Z3	6SH7GT	12BH7	56
6A7	6SK7GT	12FSGT	57
6A8GT	6SL7GT	12Q7GT	58
6AB4	6SN7GT	12SBGT	70L7GT
6AB7	6SO7GT	12SA7GT	77
6AC5GT	6S7	12SC7	78
6AC7	6U7GT	12SG7	117L7GT
6AG5	6U8	12SL7GT	117Z3
6AK5	6V6GT	12SL7GT	117Z6GT

ANY ASSORTMENT—TAKE WHAT YOU WANT 6c per tube extra for orders less than 100 tubes

## NEW PICTURE TUBES

SIZE	PRICE	SIZE	PRICE
10BP4B	11.95	17LP4	21.95
12LP4A	13.95	17TP4	21.95
12UP4A	<b>18.95</b>	19AP4B	27.95
14BP4	18.95	19DP4B	27.95
14CP4	18.95	20CP4	<b>26.95</b>
16AP4	19.95	20DP4	28.95
16AP4A	19.95	20HP4	28.95
16DP4A	19.95	21AP4	27.95
16EP4A	19.95	21EP4	27.95
16GP4A	19.95	21FP4	28.95
16JP4A	19.95	21MP4	29.95
16KP4	17.95	21WP4	27.95
16LP4A	17.95	21YP4	28.95
16RP4	17.95	21ZP4	27.95
16TP4	17.95	24CP4	49.95
16WP4A	19.95	27EP4	27.95
17BP4A	19.95	27GP4	27.95
17CP4	21.95	27LP4	<b>59.50</b>
17GP4	21.95	27NP4	27.95
17HP4	21.95	27RP4	27.95

ALL TUBES THROUGH 21" GUARANTEED 1 YEAR 24" AND 27" GUARANTEED 6 MONTHS

### \$1.49 PER HUNDRED

200 for \$2.50

All good values, sizes and types 1/2-1-2 watts -2% -5% -10% -20% Precision-Insulated Carbon -Carbon-Deposited Carbon.



#### SURPRISE KIT

10 lbs. Net of Reliable Radio and T. V. Parts—Each Kit includes a new Radio Cabinet—Good for 5 to 8 Tube Chassis.

**\$1.98**

.001 @ 600V	} 25 for \$1.25
1 @ 400V	
molded Sprague	
40-40 @ 150V	} 10 for \$2.39
120-50 @ 150V	
10-10 @ 450V	
60 @ 150V	

TERMS: 25% DEPOSIT with order, balance C.O.D. ALL shipments F.O.B. Chicago. ORDERS LESS THAN \$5.00—\$1.00 SERVICE CHARGE. These prices supersede all previously advertised prices, subject to change.

## PREMIER TV Radio Supply

3239 W. North Ave.

Chicago 47 • A Raitage 6-5350

Write for FREE Bargain Catalogs

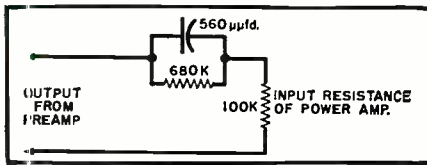

Fig. 6. A simple equalizer circuit for amplitude-sensitive types of pickup that can be placed between preamplifier and the power amplifier. It is calculated on the basis of the power amplifier having an input resistance of 100,000 ohms. For other values, the resistance should be multiplied and the capacitor divided by the factor by which the input resistance differs. For example, with an input resistance of 500,000 ohms, the resistance should be 3.3 megohm and the capacitor 120  $\mu\text{fd}$ . (nearest value). The arrangement should be carefully shielded, because of high impedance.

the equalization of the preamplifier or maybe the resistor should be changed to suit the cartridge.

All of the foregoing cartridges require a low-level or high-gain input at the preamplifier to get sufficient gain to supply the power amplifier.

The piezoelectric pickups and the Weathers FM pickup each provide a high-level output that does not need a low-level input on the preamplifier. On the contrary, a high-level input, such as that normally used for input from a tuner, is adequate for this purpose.

The input should be high impedance. This is essential for the piezoelectric type, otherwise there will be a low-frequency loss due to the fact that the pickup has a capacitance source impedance instead of a resistance.

Quite pleasing results can be obtained with these pickups without any equalization, but this really assumes that the discs have a constant-amplitude instead of constant-velocity recording characteristic. A little equalization, using the response shown in Fig. 4C, produces an over-all flat response from this type of cartridge. If this is not provided in the preamplifier, a useful circuit for adding it between the preamplifier and power amplifier, assuming that the input resistance of the power amplifier is 100,000 ohms, is shown in Fig. 6. Take care to shield the entire circuit to avoid hum pickup.

The life of any pickup being limited, and it being a vital link in phono reproduction, if you have any perfectionist leanings, you will probably end up trying at least one of each type in the course of time.

To summarize then: for a low-cost system, requiring a pickup with reasonable fidelity and a large output, the ceramic and crystal types are ideal; but if you want to get absolutely the best from your records, in terms of both reproduction and number of playings before wear begins to show up, you need a type that will reduce stylus force necessary and give you the lowest distortion. Suitable types are: the higher quality variable reluctance, the moving coil, and the ribbon. Taken in this order, however, they will require progressively more gain from your pre-

## SAVE \$\$\$ ON TUBULAR CONDENSERS

### COMPACT TUBULAR ELECTROLYTICS

Top Quality—Fresh Production—Guaranteed 1 Yr.

Cap. Mfd.	Wkg. V.DC	Net Ea.	10 at Ea.	Cap. Mfd.	Wkg. V.DC	Net Ea.	10 at Ea.
8	450	.35	.32	20-20	150	.45	.42
8-8	450	.54	.50	30-30	150	.48	.45
10	450	.36	.33	40-40	150	.51	.47
12	450	.38	.35	50-50	150	.54	.50
16	450	.42	.39	40-20	150	.48	.45
20	450	.47	.44	50-30	150	.51	.47
40	450	.54	.50	50	25	.30	.28

**UTAH PM REPLACEMENT SPEAKERS**  
 4" RD. \$1.27 ea. 6" RD. \$1.95 ea. 10" RD. \$3.44 ea.  
 5" RD. \$1.34 ea. 8" RD. \$2.77 ea. 12" RD. \$4.08 ea.

**COAXIAL CONNECTORS**  
 RG-8/U COAXIAL CABLE  
 Brand New. Govt. Surplus  
 • 100 ft. \$5.95 • 250 ft. \$13.25 • 500 ft. \$25.00

**TV SERVICE LAMP**  
 • Mounts anywhere; rubber padded spring clamp.  
 • Swings to any position with 2 ball joints.  
 Ideal for inside cabinet work, work bench, or reading light. Comes with 6 ft. cord.

**\$1.95** ea. **Less Bulb**

GE 1RPM SYNCHRONOUS TIMING MOTOR—Wafer Thin 115V-60 Cy. 2.5W ..... \$1.15  
 HAYDON 4RPM TIMING MOTOR 115V-60 Cy. .... \$1.79  
 2.2W .....

1" CR TUBE TYPE 1AP5/P11. NEW ..... \$6.50  
 GR. MICROPHONE HUMMER TYPE 572B ..... 7.50  
 • 5UL BATTERY INT'L RECT B2M output .5V 2MA ..... Pr. 1.49  
 Sound powered units—talk & listen ..... Pr. 2.21  
 NTC-6 Storage Battery 6 V. 4 Amp Hrs. .... ea. 1.95  
 BE-54A Storage Battery 2V. 20 Amp Hrs. .... ea. 1.95  
 FL-8-A FILTER—1020 cycle—like new ..... 1.95  
 #47 PILOT BULBS ..... Box of 10 .69

**Brand New TUBE SPECIALS Guaranteed**  
 VR-105 .... .85 304 TL .....10.50 866A .....1.25  
 VR-150 .... .85 807 .....1.25 872A .....2.75  
 211 ..... 75 813 ..... 9.95 CK1013 .....2.25  
 WB 249B .....3.75 837 ..... 95 8020 .....1.50

**SEND FOR FREE BARGAIN BULLETIN**  
 TERMS: Cash with order or 25% deposit—balance C.O.D. Net 10 days to rated accts. All prices net F.O.B. our warehouse. Market 7-3999

## ELECTRONIC DISTRIBUTORS

727-29 ARCH STREET  
 Philadelphia 6, Pa.

## SAVE TIME...



on EVERY TELEVISION SERVICE CALL with the NEW

## Senco UNIVERSAL TV Jumper Cord

Carry only one Jumper Cord for all TV Sets

- Extends Power from back of TV Set—no more moving of furniture to get to the wall plug
- Turn set off from rear
- No more winding and unwinding cords
- Two handy power outlets for soldering iron and test equipment
- Fits many speakers, focus coils, etc.

Write for illustrated Literature. . . .

## SERVICE INSTRUMENTS COMPANY

ADDISON, ILL. (Chicago Industrial Suburb)  
 In Canada: Emerald Television Corp., Montreal



amplifier. Another high-quality possibility is the *Weathers* FM pickup, which needs the FM demodulator that comes with it, but has a high-level output.

**EDITOR'S NOTE:** *The general comments with regard to the crystal cartridges are, of course, the opinions of the author and are generally well-known. However, we would like to call to the reader's attention that there are crystal cartridges on the market today that, according to the manufacturers, are extremely good to a point where they compare favorably with magnetic units. These reports have not been verified as yet.*

One of the most important things about the performance of a pickup is its frequency response. But published responses are of rather limited meaning, particularly at the high end; this is because the record material compliance contributes toward the response measured and different test records use different pressing compositions, and so do not give consistent results with different pickups. This means that pickups will not give consistently different performance either, when compared on program records using different pressing composition. For this reason, published characteristics can best be assessed by listening to the differences they represent, which means the ear should be the final arbiter in making a choice. After making your preliminary choice from the published data, it is advisable to listen to the pickup played through your own equipment, or one as similar to it as possible, to judge whether or not it will give satisfaction.

Happy hunting!

-30-

## REPAIR NOISY CONTROLS

BY PAUL FALK

**A**LTHOUGH it is a general practice to replace noisy controls, it is sometimes impossible to obtain an exact or even suitable replacement.

There is one type of control that can be repaired satisfactorily if a little care is taken. On this type of control the carbon element is sprayed onto a flat C-shaped washer made of cardboard or porous fiber. Noise in these units is almost always due to a slight warping or moving of this element as the contact moves over its surface. If the element can be cemented securely to the fiber base of the control, the noise will disappear.

For the repair of such units, remove the control from the chassis and take off its rear cover and switch section (if any). Remove the shaft and contact assembly. Notice that the C-element is riveted onto the fiber base at the ends and at the tap, if it is a tapped control. Pry the element away from the base and apply radio cement to its under surface. If any cement gets on the top surface of the element, remove it immediately with solvent. Clamp the element in position for about 20 minutes with spring-type clothespins or alligator clips. Clean all moving contacts with carbon tetrachloride and reassemble the control.

This repair will not work with controls which have badly pitted or worn elements.

-30-

January, 1956

# CROWN Professional Tape Recorder

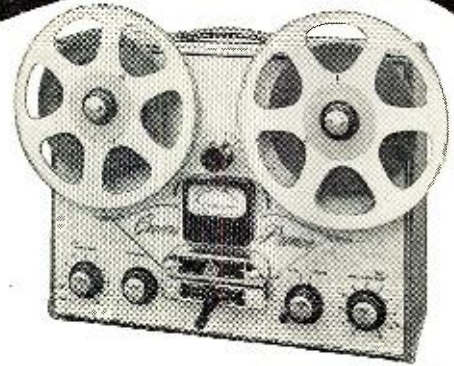

## CROWN PRINCE

**Breaks Sound Barrier  
20-20,000 CPS usable at 7 1/2 IPS**

The only Complete Professional Recorder as a single easily portable unit using 10 1/2" reels . . . Three speeds: 15, 7 1/2, 3 3/4 IPS . . . 10 1/2" reels—can be rack mounted . . . Hi-Z Mike and Phono Input . . . Cathode Follower Output . . . Size: 19" x 14" x 7 1/2". Wt. 38 lbs.

**Dual Track—\$349.50 Full Track—\$399.50**  
Complete less case.

Write for literature. Address Dept. RN1.

### SPECIFICATIONS

"Micro-Linear" Heads  
Three Speeds  
Three Motors  
Meets NARTB Standards  
"Micro-Sync" Timing  
Straight Line Threading  
4" Dual Lighted Meter  
Magnetism Braking  
Perfect Erasure

★ ★ ★ ★

### GUARANTEED

Record & Playback Performance

IPS	15	7 1/2	3 3/4
% WOW	.02	.18	.25
DB	-2	±2	±3
CPS	20 to 30,000	30 to 30,000	30 to 30,000
NOISE RATIO	30	52	44

for Full Track Heads

## INTERNATIONAL RADIO & ELECTRONICS CORP.

Elkhart Indiana

WANT POWER & VERSATILITY?

**FOLLOW THE LEADER...**



©55

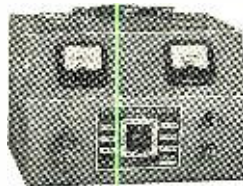

**KIT  
\$29.95**

**Wired  
\$38.95**

### 6V & 12V BATTERY ELIMINATOR & CHARGER #1050

- operates 6V and 12V auto radios for servicing and sales demonstration.
- charges 6V and 12V storage and Edison Batteries.
- operates mobile and marine receivers, transmitters, boat lights, electric trains, projection and other equipment.

#### SPECIFICATIONS

- 6-Volt range: 0-8V (up to 20 Amp.)
- 12-Volt range: 0-16V (up to 10 Amp.)
- variac-type transformer for continuously variable voltage adjustment.
- reads volts and amperes at same time on 2 separate meters.
- Transformer primary and secondary fully protected.

In stock at local jobbers throughout the world. Write for free Catalog RB-1.

Prices 5% higher on West Coast

**EICO**

84 Withers Street  
Brooklyn 11, N. Y.



# MELLOTONE

SARAN

## GRILLE FABRICS

A dramatically NEW improvement for SOUND and BEAUTY . . . found only in MELLOTONE grille cloth!

MELLOTONE'S amazing qualities make it the nation's No. 1 Saran Grille Cloth . . . offering the widest selection of colors and designs to complement your Hi-Fi, Radio, or T.V.

Look for MELLOTONE Package Display units at your local dealer.



**WENDELL PLASTIC FABRICS CORP.**

17 West 17th St., New York 11, Dept. H.

151



# RAD-TEL

**LEADS IN TUBES & Parts BUYS**

Same Day Service  
Full Year Guarantee  
All Tubes 125¢ Boxed  
400 Types In Stock  
For Quality, Performance,  
Dependability.

**RT-24/APX-2**  
**IFF EQUIPMENT**

44 tube transceiver with usable parts, tube sockets, relays, coax fittings, condensers, resistors, etc. 24 volt Blower motor. 24V gear train motor. Power transformer 400 to 2400 cycles. Original gov't. cost \$750.00. Less tubes. EACH, ..... Shipping weight 45 lbs.



**SPECIAL!** Same RT-24/APX-2 in sealed overseas carton complete with 44 tubes; 11-6AG5; 19-6C4; 1-OD3 VR150; 1-2C26; 7-6J6; 4-9006; 1-5Y3; 1-2D21. **\$1795** Ea.

List price of tubes alone \$81.00. Ship. by railway only. Approx. wt. 46 lbs. **\$16.95** Lots of 3

## ATTENTION!

**SCHOOLS, HOBBYISTS, RADIO TECHNICIANS!**

**CATHODE RAY SCOPE TUBE**

3API, made by famous tube maker - Jan type! Electrostatic focus and deflection. Medium 7 pin base. Individually cartoned. Packed for export. Regular net \$15.75.

**SINGLE 99c** each

**79c** ea. Lots of 4 indiv. packed 4 to a carton



Type	Price	Type	Price	Type	Price
0Z4M	.65	6AS6	1.49	7F7	.79
1A2X	.62	6AT6	.41	7E7	.79
1B3GT	.73	6AT8	.72	7H7	.59
1LA4	.59	6AU6	.46	7J7	.79
1L0S	.59	6AW8	.83	7L7	.69
1LE3	.59	6AV5GT	.83	7N7	.69
1LH4	.69	6AV6	.40	7Q7	.56
1LNS	.59	6AW8	.83	7R7	.79
1RS	.62	6AX4GT	.65	7Y4	.69
1U4	.50	6AX7	.64	12A4	.60
1U5	.50	6BA5	.54	12AT6	.37
1X2A	.68	6BC5	.54	12AQ5	.52
2A4F4	.42	6BC7	.82	12AT7	.72
2D21	1.20	6BE6	.77	12AU6	.46
3A3	.80	6BG6	1.25	12AU7	.60
3AL5	.42	6BH6	.53	12AV6	.39
3AU6	.46	6BK5	.80	12AX4	.67
3AV6	.41	6BK7	.80	12AX7	.63
3BC3	.52	6B17GT	.91	12BE6	.51
3BE6	.52	6BN6	.74	12BF6	.39
3BN6	.74	6BQ6GT	.98	12C17	.63
3BZ6	.55	6BQ7	.90	12BK5	.70
3C86	.64	6BZ7	.90	12BQ6GT	.99
3C56	.52	6C27	.90	12BY6GT	.64
3Q4	.59	6C86	.40	12BZ7	.65
3S4	.59	6CD6	1.11	12CR6	.51
3V4	.58	6CF6	.64	12C16	.59
4B07	.90	6C56	.51	12L6	.51
4B27	.90	6C6E	.98	12S17M	.67
5AM5	.75	6H6GT	.41	12SK7GT	.63
5AN8	.78	6H7GT	.48	12S7GT	.57
5AQ5	.75	6J6	.64	12SN7GT	.59
5AT8	.75	6K6GT	.45	12SQ7GT	.56
5BK7A	.82	6K7	.45	12S7GT	.56
5B6	.66	6K8	.45	12W6	.63
5T4	.69	6L6	.45	12X4	.38
5T8	.81	6S4	.48	14B6	.63
5U4G	.85	6S7GT	.55	19A14	.79
5U4GB	.90	6S17GT	.50	19B6	1.39
5U8	.78	6SK7GT	.53	19T8	.69
5V4	.71	6T7GT	.67	25A7GT	.83
5V6	.50	6SN7GT	.67	25BQ6GT	.98
5X8	.75	6SQ7GT	.46	25CDE	1.44
5Y3GT	.37	6T4	.99	25CUG	1.01
6A4	.46	6T8	.99	25L6GT	.51
6AC7M	.86	6UR	.78	35C5	.52
6AF4	.90	6V6GT	.50	35L6GT	.51
6AC5	.56	6V8	.86	35W4	.47
6AG7M	.99	6W4GT	.47	35Y4	.54
6AH4	.67	6W6GT	.37	35Z5GT	.49
6AK5	.95	6X4	.37	50A5	.55
6AK6	.59	6X5GT	.37	50B5	.55
6AL5	.42	6X8	.75	50C5	.51
6AM8	.78	7A5	.59	50L6GT	.61
6AN4	.78	7A7	.69	11723	.45
6AN8	.78	7A8	.69		
6AQ5	.50	7AG7	.69		
6AG6	.77	7AU7	.61		
6AQ7	.70	7C6	.59		
6AR5	.45	7C7	.59		
6AS5	.45	7C7	.59		

WRITE Dept. RN-1 for FREE Tube and Parts Catalog Listing Over 400 Tube Types.

EXPORT INQUIRIES INVITED

TERMS: 25% deposit must accompany all orders—balance C.O.D. All shipments F.O.B. Irvington warehouse.

**Rad Tel TUBE CO.**

"Integrity is Our Chief Asset!"

115 COIT ST., IRVINGTON II, N. J.

### Within the Industry (Continued from page 32)

Annual Industrial Show, Wednesday and Thursday, Jan. 25th and 26th, at the Penn Sherwood Hotel in Philadelphia. According to reports, some ninety to one hundred of the leading industrial manufacturers of the electronic industry will participate. In addition, about twenty-eight radio amateur clubs will be represented.

This show, which is sponsored exclusively by *Almo Radio*, should be of considerable interest to all radio amateurs and anyone who desires first-hand information on industrial electronics in all its aspects.

For additional information, write direct to the company, 509 Arch St., Philadelphia, Penna.

**ROBERT G. DAILEY** is the new vice-president of *Vokar Corporation*, Dexter, Michigan manufacturer of auto radio vibrators and a line of subminiature electronic components.



He joined the firm in 1954 as general sales manager and will continue to direct all sales activities in his new post.

A 1937 engineering graduate of the University of Michigan, Mr. Dailey was formerly sales promotion manager of the *General Motors*' truck and coach division and prior to that was sales manager of the *Reid Division of Standard Products Company* of Cleveland.

**WESTINGHOUSE ELECTRONIC TUBE DIVISION** is initiating a tooling-up program of over \$1,000,000 to implement production of its new all-glass color television picture tube in the Elmira plant.

Orders have already been placed for approximately \$500,000 worth of new equipment—primarily exhaust machines. Plans are to have the new *Westinghouse* rectangular shadow-mask color picture tube ready for commercial production by the early part of 1956.

### NEW TV SERVICE GROUP

THE organization of a new TV service mutual aid group for the purpose of "educating the public to good service practice at fair prices," has just been announced in Oklahoma City, Oklahoma. Called the *Television Service Association of Oklahoma*, membership is open to those service technicians who can conform to the ethical standards established by the association. The association, in turn, will impress upon the public the advantages of dealing with their members.

Additional information regarding the TSA of Oklahoma may be obtained by writing to Mr. Bob Armstrong, executive secretary, P.O. Box 9664 Shartel Station, Oklahoma City 18, Oklahoma.

### Is This In Your Attic?



**Berliner Gramophone**

**ALSO WANT**

**Columbia Grand Graphophone**  
**Hill Talking Machine**  
**Improved Gramophone (Zon-o-phone)**  
**Eagle Graphophone**  
**Victor Models A, B, C & D**  
**Friend Talking Machine**  
**Columbia AY Disc Graphophone**  
**Edison Concert Phonograph**  
**Edison and Columbia Coin Machines**  
AND  
Miscellaneous disc and cylinder phonographs with "outside" horns.

Write full description to  
**RADIO & TELEVISION NEWS**  
Box 50  
366 Madison Ave. New York 17, N. Y.

## L M B BOX CHASSIS

Flangelocking Precision Engineered Interlocking

65 sizes and shapes for the laboratory, manufacturer, industrial, experimenter, builder, and general applications where metal boxes are required. Stocked by all electronic and geophysical distributors. Send for free catalog.

**L M B** 1011 Venice Blvd.  
Los Angeles 15, Calif.

## TAPE RECORDERS

Tapes—Accessories  
Nationally Advertised Brands  
UNUSUAL VALUES  
Send for Free Catalog  
**DRESSNER**  
Box 66RA, Peter Stuyvesant Sta., New York 9, N. Y.

MERITAPE  
Low Cost, High Quality Recording Tape—in boxes or cans.

Ready Now! Two  
Timely Low Cost Books

## "PRINTED CIRCUITS and PRINTED WIRING"

Printed circuits are now standard in virtually all new television, radio and hi-fi amplifier production. Completely new service techniques are required to repair these circuits. This new *Sprayberry* book covers types of printed circuits with service instructions for each. Shows how to replace defective components and repair foil. Covers tools and equipment needed; profusely illustrated. Just off the press—send for yours today.

**"RADIATION DETECTORS, GEIGER and SCINTILLATION COUNTERS"**

The most up-to-date book available covering operation and servicing of uranium and other radiation ore prospecting equipment. Thoroughly explains operation and theory of geiger and scintillation counters; covers types of tubes used and methods for obtaining high operating voltages from low voltage source. Covers proper servicing procedure and calibration. Enables any electronic technician to earn top money servicing these units. Illustrated with pictures, diagrams and service charts.

Each Book **Only 50¢** POSTPAID

Send 50¢ coin (no stamps) for one or \$1.00 for both **SPRAYBERRY ACADEMY OF RADIO**  
Dept. 25-GA, 111 N. Canal St., Chicago 6, Illinois



# What's New in Radio

## TUBE TESTER-REJUVENATOR

*Electronic Measurements Corporation*, 280 Lafayette Street, New York 12, N. Y. is now offering a low cost tube tester and rejuvenator as its Model 209.

This combination instrument permits the checking of all types of vacuum tubes in addition to effecting repairs on monochrome picture tubes. It is available in three different forms; wired and tested in a hammertone case, wired and tested in an oak carrying case, and in easy-to-assemble kit form.

The instrument tests tubes by using the standard, total emission method. All octal, loctal, miniature, and noval base tubes can be evaluated with this unit. Rapid checks can be made for tube quality, shorts, leakages, continuity, and opens occurring between any

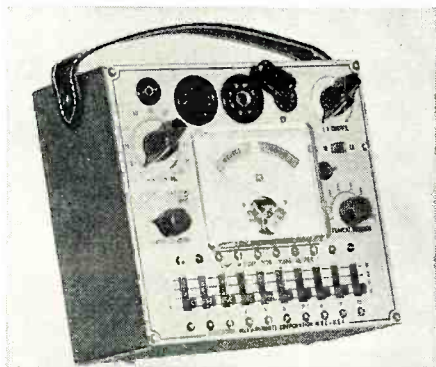

two tube elements. A plastic meter with a 3 1/2" easy-to-read scale reads "Reject-?-Good."

With an accessory picture tube adapter the Model 209 can be used as a CR tube rejuvenator.

## REPLACEMENT FLYBACKS

*Triad Transformer Corporation*, 4055 Redwood Ave., Venice, California has added five new flyback transformers to its line of TV replacement components.

Designed for use in *RCA*, *Travler*, and *Zenith* television receivers, these new items are electrically and mechanically interchangeable with the manufacturer's original equipment. Wherever possible they are composite replacements to fill a number of requirements where mechanical and electrical specifications are identical.

A copy of Catalogue TV-155 giving specifications on the entire line of replacement transformers is available from the firm's distributors or from the company direct.

## MARINE RADIO EQUIPMENT

*Sonar Radio Corporation*, 3050 West 21st Street, Brooklyn 24, New York

# FREE! CATALOG

BA's NEW 1956

**YESSIR-IT'S THE KING-SIZE CATALOG--**  
**164 "KING-SIZED" (8 1/4 x 10 1/2) PAGES**  
**OFFERS MORE ITEMS PER PAGE--IT'S EASIER TO USE...IT'S EASIER FOR YOU TO ORDER**

# BA

SINCE 1927

*A Complete Buying Guide for Everything in-*  
**RADIO TELEVISION ELECTRONICS**

COMPLETE GUIDE TO EVERYTHING IN RADIO, TV, ELECTRONICS

100'S OF BRAND NEW ITEMS LISTED HERE FOR THE VERY FIRST TIME

INCLUDES 21 BIG PAGES OF BARGAINS NOT FOUND IN ANY OTHER CATALOG

DEALERS, SERVICEMEN, SCHOOLS, BROADCASTERS, INDUSTRIALS, THEATRES, MANUFACTURERS, CHURCHES, HOTELS, PUBLIC UTILITIES, EXPERIMENTERS, ENGINEERS, LABORATORIES, AMATEURS

**BURSTEIN-APPLEBEE CO.**  
 1012-14 McGEE ST., KANSAS CITY 6, MISSOURI

**RUSH COUPON FOR THIS BIG CATALOG NOW!**

**BURSTEIN-APPLEBEE CO. Dept. M,  
 1012-14 McGee St., Kansas City 6, Mo.**

Send Free B-A Catalog No. 561.

NAME \_\_\_\_\_  
 ADDRESS \_\_\_\_\_  
 CITY \_\_\_\_\_ STATE \_\_\_\_\_

## ADAPTER



Write for Bull. 354B  
**TYPE 7B \$2.25**  
**TYPE 8B \$2.50**  
**TYPE 9B \$2.75**  
 (ILLUSTRATED)  
 plus shipping chgs.

- Min. size for use in crowded spaces
  - RETMA color coded terminals
  - Uses (All above chassis)
1. Modify circuits for max. performance and testing without soldering or unsoldering.
  2. Break into any circuit for trouble shooting.
  3. Measure voltage, resistance and current in conjunction with standard instruments.

**A. L. PRODUCTS CO., INC.**

311 Hickory St., Kearny, N. J.

NOW IN STOCK at NIDISCO

**TEICO**

**COLOR & MONOCHROME Laboratory &**

**TV SERVICE 5-MC SCOPE**

713 Newark Av., Jersey City, N. J.  
 55 State St., Hackensack, N. J.  
 294 Passaic St., Passaic, N. J.  
 658 Anderson Av., Cliffside, N. J.  
 128 S. Warren St., Trenton, N. J.

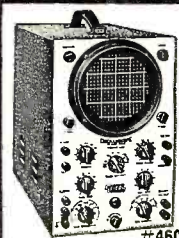

**KIT \$79.95**  
 Factory Wired \$129.50





**NEW FOR '56!**  
**CREDIT BONUS PLAN!**  
FIRST TIME EVER IN ELECTRONICS!

EVERY PURCHASE GOOD FOR "CREDITS" TOWARD YOUR FREE BONUS KIT!

**As always YOUR CHOICE OF ANY KIT FREE WITH EACH \$10 ORDER!** (Amounts over \$10 will be credited to your account.)

**HERE'S HOW IT WORKS:** With first purchase you are issued a Credit-Bonus Card, showing 1 credit for each dollar of your purchase. Send your Credit-Bonus Card with each order, to have credits entered. When your Card shows 10 credits, you get the kit you choose, FREE!

**START EARNING YOUR FREE BONUS KIT TODAY!**

- 60 MICA CONDENSERS.** Rare buy! Postage stamp type, 25 values, .0001 to .01 mf. Many silver, 5% too! Wt. 1/2 lb. Reg. \$1.87.
- 50 CERAMIC CONDENSERS.** A Kit King first! 25 values in disc, button & tubular ceramics, 5 mmf. to .01 mf. to 1000 V. Duals, too! Wt. 1/2 lb. Reg. \$1.81.
- 25 TUBE SOCKETS.** USA first! Subminiatures, 7 & 9-pin miniatures, 4, 7, 8-pins. Radio, TV, lab must! Wt. 1 lb. Reg. \$9.
- 15 VOLUME CONTROLS.** More-for-less! 10 values, concentric & W. too! Some w/switch. Wt. 1 lb. Reg. \$13.
- 15 ROTARY SWITCHES.** Scoop! Sing. & 2 gang. Experimenters, note! 2 lbs. Reg. \$14.
- 10 TOGGLE MICRO. PUSH SWITCHES.** Some ers' special! Wide variety, with 10 "on-off" plates. Wt. 1 lb. Reg. \$8.
- 10 CHASSIS.** Never before! 1, 2, 3, 4 & 6 tube chassis, for amplifiers, pre-amps, power supplies, etc. Shop must! Wt. 3 lbs. Reg. \$9.
- 30 BATHTUB & TUBULAR SWIT.** Wide variety of values; .005 to 2 mf., up to 600 V. Wt. 3 lbs. Reg. \$25.
- 60 TUBULAR CONDENSERS.** 25 values; .00025 to .01 mf. to 1600 V. Moulded, too! Wt. 2 lbs. Reg. \$10.
- 60 CARBON RESISTORS.** Insulated, 35 values; 15 ohms to 10 meg; 1/2, 1 & 2 w. Many & 5%, famous Allen Bradley, too! Wt. 1/2 lb. Reg. \$18.
- 125 CARBON RESISTORS.** 40 values; 100 ohms to 1 meg; 1/2, 1 & 2 w. Many 5%. Uninsulated. Wt. 1 lb. Reg. \$21.
- 2000 PCS. HARDWARE.** Screws, washers, jugs, grommets, etc. Wt. 3 lbs. Reg. \$11.
- 1000 PCS. SPAGHETTI.** Precut for shop use. Lengths to 4", 8 sizes; #18 thru #36. Ass'd. colors, insulation. Wt. 1/2 lb. Reg. \$7.
- 8 PC. NUTDRIVER KIT.** Plastic handle, 3/16, 7/32, 1/4, 5/16, 11/32, 3/8, 7/16" steel socket wrenches in plastic case. Wt. 1/2 lb. \$3.50 value. Reg. \$2.69
- TEN 25-FT. ROLLS WIRE.** Plastic & cloth insulated. Solid and stranded, #18 to #24. Ass'd. col. ors. Wt. 1 lb. Reg. \$5.
- 10 TWIST LOCK ELECTROLYTICS.** 5 to 100 mf., up to 450 V. Each can different values. All multiple sections. Wt. 3 lbs. Reg. \$8.

- 40 MOULDED CAPACITORS.** Stastic, cased domino, postage stamp types, .001 to 0.1 mf. Ass'd. popular values. Wt. 2 lbs. Reg. \$14.
- 20 POWER RESISTORS.** Wirewound. 20 values to 10,000 ohms; 5 to 50 W. Candelum & tubular. Wt. 1 lb. Reg. \$12.
- 4 POPULAR DIODES.** Exclusive! One each, 1N21, 1N22, 1N23, 1N51. In poly bag. Shop must! Reg. \$6.28.
- 200 COIL FORMS,** ceramic and bakelite, 2-3 sizes, styles. Some worth \$2. A \$20 value. Wt. 2 lbs.
- 15 PRECISION RESISTORS.** 15 values, up to 100 meg! Carbo-film and W. 1% tol. 1/2, 1 & 2 Wt. 1/2 lb. Reg. \$18.
- 50 RF COILS & CHOKES.** Shop asst. 20 types; osc., peaking, RF, slug-tuned. Wt. 1 lb. Reg. \$21.
- 70 TERM. POSTS & STRIPS.** Ass'd. binding posts, screw & solder lug strips (1 to 9 terms.) Wt. 1/2 lb. Reg. \$5.
- 25 INSTR. KNOBS.** Exp't. types, Ass'd. bakelite round, knurled, pointer, skirted. Set screw & brass insert. Wt. 2 lbs. Reg. \$12.
- 40 TRIMMERS.** New! Lowest USA price! Pop. mica compression trimmers, 12 ass'd. values, slider duals, triples. Wt. 1 lb. Reg. \$16.
- 75 KNOBS for radio, TV, appliances.** Some worth 25¢. Push & set-screw types. Wt. 1 lb. Reg. \$8.
- 10 TV & RADIO IF TRANS.** Popular replacement IF's. Some double trimmer types. Wt. 2 lbs. Reg. \$20.
- 150 COMPONENTS.** Wow! Wire; electrolytic; paper, mica, stastic tubular; disc ceramics; mica; resistors. Pre-cut leads. Wt. 1 lb. Reg. \$15.
- 10 ELECTROLYTICS.** Ass'd. 5F and tubular types. 8 to 1000 mf., to 450 V. Multiple sections, too! Reg. \$12. Wt. \$1 1 lb.
- 30 DISC CONDENSERS,** ceramic. Second 4.7mmf. to .01mf. Ass'd. values; 1000 V. Duals, too! Wt. 1 lb. Reg. \$10.
- G-E PRE-AMP KIT,** for magnetic cartridges. Chassis, condenser, resistor, wire gear and schematic for famous pre-amp equalizer. (6SC7 tube, 69C-5D). Wt. 1 lb. Reg. \$4.50.
- 8-PC. POCKET TOOL CHEST.** Workshop must! Chisel,awl,tack lifter, Phillips #0 & 1, 3/16 & 1/8 screwdrivers, plastic handle. A \$3.50 value! Wt. 1 lb. Reg. \$1.

**CHECK THESE NEW YEAR'S BELLRINGERS!**

**SAVE \$7 ON FAMOUS CLOCK-TIMER!**



**WESTON 0-100 MICROAMP METER \$3.33** REG. \$21... only \$3.33

- CONTROLS APPLIANCES, LIGHTS
- HUNDREDS OF USES!
- HANDSOME CHROME FINISH!
- TURNS DEVICES "ON OR OFF" WITHIN 12-HOUR PERIOD
- CLEAR PLASTIC CASE
- WEIGHS ONLY 2 OZ.
- ONLY 1 3/4" x 2"
- RED MARLINE POINTER
- SCALE READS 0 to 25
- ALL BRAND NEW!
- TWO FOR \$6.00

WRITE FOR NEW 1956 BARGAIN BULLETIN!

**HOW TO ORDER** Check items wanted. Return entire ad with check or M.O. Incl. sufficient postage, excess returned. Ratec. Net 30 days. PE-1

Name ..... (Please PRINT)  
Street .....  
City ..... Zone ..... State .....

Enclosed \$..... for kits, \$..... for postage.  
**LEKTRON SPECIALTIES**  
28 GARDNER STREET CHELSEA 50, MASS.

has added the "Snap-On, M35WS" to its line of marine radio equipment.

The new unit is a 35-watt radio with five marine channels, plus a broadcast band, designed for permanent installation on any vessel. It has an effective range of 50 to 200 miles.

The installation consists of a power supply which is located remotely, a tray that is permanently connected and mounted to the bulkhead in the binacle area, through which the power cable of the power supply is fed, and the receiver-transmitter which is snapped on or off from the tray and

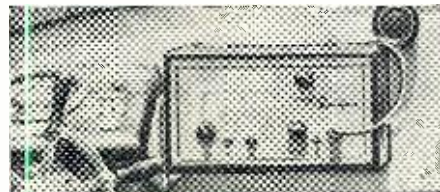

connected by means of a polarized plug. The unit comes complete with power supply, two pairs of crystals, a push-to-talk carbon mike, and a 17-watt p.a. system.

**PC VARNISH**

A new varnish designed especially as a protective insulating coating for modular assemblies, printed circuits, and printed circuit components has been developed by the *Schenectady Varnish Company* and is being marketed by *The Inst-X Sales Company*, 26 Rittenhouse Place, Ardmore, Pa.

More flexible than conventional coatings, the #642 printed circuit varnish can be baked or air-dried to a tough, resilient coating that completely seals the laminate and component leads against arc-producing moisture. A 2 1/2 mil coating will withstand 1250 volts even after 72 hours exposure at 100% relative humidity. This highly arc-resistant varnish will not support tracking, nor will it char.

**HICKOK V.O.M.**

*Hickok Electrical Instrument Company*, 10524 Dupont Ave., Cleveland 8, Ohio has developed a portable v.o.m. which features a new technique that protects both meter and the entire internal circuit against accidental burnouts.

In the event of dangerous overload, the instrument disconnects itself and

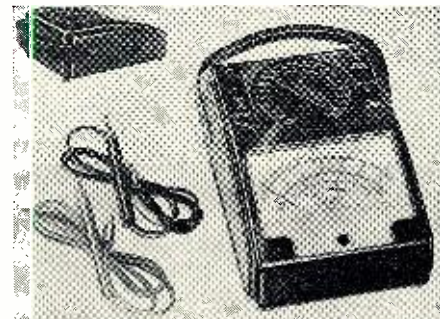

raises a reset button on the case. Thus any high voltage may be applied directly across any function without

Surplus Industrial **ELECTRONIC** Components Equipment

**W. E. STEPPER**—44 Steps—4.5-24 VDC—New—7.95—10/65.00

**MOTOR**—Diehl. Mfg.—6VDC—1.95

6.5A—Double End Shaft..... 2 for 3.00

**24 VOLT TRANSFORMER**—PRI-115V-60 cy.—1.5 A. 2 for 3.00

Ea. 1.59

**TRANSFORMER**—PRI-110V—3 Phase—60 cy.—Secondary 3700 Volts—1.5 Amps—Air Cooled—Manuf. Acme—17"x13"x12". New. Crated. 69.95

Wt. 300 Lbs. .... 1.95

**ARR/1—UHF RECVR**—New—with Tubes and Conversion..... 2.00

**MAST BASE**—MP-22A—Spring Swivel—New..... 2 for 3.00

**CO-AX RELAY**—SPDT—Instant Cutoff—Energizing Voltage May Be 12VDC to 115VAC—with 2 Co Ax Connectors Housed in Acminom Case—Value at 1.95.... 2 for 3.00

**TS-1731UR**—Hi-Freq. BC221. (90-450 MC.). 115VAC Pow. Supp. Modulated—Compl. w/Spares, Book, Ex..... 150.00

**BEAM POWER TUBE**—1625—New. Boxed. Doz. 2.50—100...ea. 22c

**REX RADIO SUPPLY CO.**  
88 CORTLANDT ST. N. Y. 7. N. Y.

**Radio-TV-Electronics**

Find out what an FCC license (U. S. Govt.) is and how it will insure your future success and security.

It will lead to promotions and advancements. If you are in the military services, it will enable you to convert your military job to a valuable civilian occupation!

**Send For These 3 FREE Books Now**

1. How To Pass FCC Exams
2. Money-making FCC Information
3. Master Course Sample Lesson

The industry prefers an FCC licensed technician. With an FCC license YOU will qualify for the REALLY GOOD jobs!

WRITE TODAY  
**CLEVELAND INSTITUTE OF RADIO ELECTRONICS**  
Desk RN-86 4900 Euclid Bldg. Cleveland 3, Ohio

**MOVING?**

Be sure RADIO & TELEVISION NEWS follows you. Please send your change of address to

**RADIO & TELEVISION NEWS**  
Circulation Department  
64 E. Lake St. Chicago 1, Ill.

**DON'T** Just say capacitors

Ask For Sprague By Catalog Number

Know what you're getting... get exactly what you want. Don't be vague... insist on Sprague. Use complete radio-TV service catalog C-610. Write Sprague Products Company, 51 Marshall Street, North Adams, Massachusetts.

**SPRAGUE**  
WORLD'S LARGEST CAPACITOR MANUFACTURER



danger to the meter movement or associated components.

The new v.o.m. is currently available in two models, the Industrial Model 455 which has a sensitivity of 20,000 ohms per volt a.c. or d.c. and the Audio Model 456 with a sensitivity of 20,000 ohms per volt d.c. and 1000 ohms per volt a.c. It also includes db ranges and has provisions for output measurements.

#### 4 1/2" AND 5 1/2" METERS

Two new lines of rectangular panel instruments, 4 1/2" and 5 1/2" in size, have been announced by *Simpson Electric Company*, 5200 W. Kinzie St., Chicago 44, Illinois.

The 5 1/2" instruments are available in three types: d.c. meters, r.f. meters, and a.c. rectifier-type units. Each of the three types can be supplied with external magnet meter movements or shallow or deep core magnet meter movements.

The 4 1/2" size is available in the same three meter types and can be supplied with either the shallow or deep core magnet meter movement. Both sizes are available in standard black Bakelite cases or in the firm's new modernistic black Bakelite cases with chrome trim. All practical ranges can be supplied.

#### WRL'S NEW V.F.O.

*World Radio Laboratories*, 3415 W. Broadway, Council Bluffs, Iowa is now offering its Model 755 v.f.o. in both kit and wired form.

This newly-developed circuit is easy to operate and comes complete with a built-in power supply. The unit is calibrated on 160, 80, 40, 20, 15, 11, and

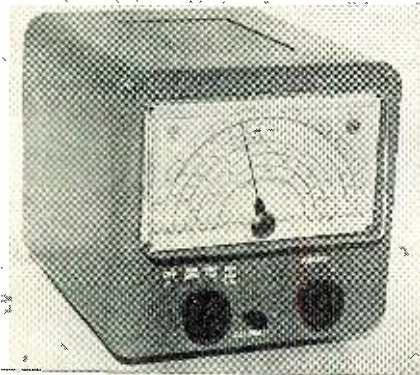

10 meters. It also incorporates a calibrated switch for zero-beating the signal frequency.

The instrument is housed in a streamlined case which measures 7" x 6 3/8" x 7 1/2". It comes complete with four feet of RG-59/U output cable and plug for a 1/2" crystal socket.

The company will supply a data sheet on this new unit upon request.

#### EICO SCOPE

*Electronic Instrument Company*, 84 Withers Street, Brooklyn 11, New York has added a 5 mc. bandwidth d.c. oscilloscope to its line of test equipment.

The Model 460 is especially designed for laboratory, production line, black

## AIREX THE ELECTRONICS SUPERMARKET

## TOP ME CHANDISE AT ROCK BOTTOM PRICES

### RECORD CHANGER BARGAINS

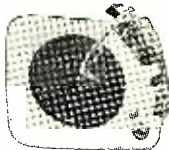

**WEBSTER MDL 140:** 3 speed intermix, automatic shut off, dual styli cart. 2 pole motor. Reg. \$37.50. **\$22.95**

**WEBSTER MDL 140 GE:** 3 speed intermix, with 31 reluctance RPX 050 cart., dual sapphire styli, automatic shut off. Reg. \$40. **\$26.95**

**GARRARD FC 80:** 3 speed, weighted turntable, 4 pole motor, automatic shut off, with heads, line cord & plug. Reg. \$49.50. **\$42.95**

**COLLARO FC 54:** 3 speed intermix, automatic shut off, weighted turntable, plug-in head. Reg. \$48.75. **\$37.50**

**COLLARO R254 WITH RONETTE DUAL SAPPHIRE STYLI HI-FI CARTRIDGE.** **\$39.95**

**MONARCH MDL UA6:** British made, 3 speed, weighted turntable, intermix automatic shut-off, 4 pole motor, with hi-fi crystal cart. & dual sapphire styli. Reg. \$49.95. **\$24.95**

**MONARCH:** same as above with RECOTON-GOLDRING 500 SS resistance cart. & dual sapphire styli. **\$29.95**

### RECORD CHANGER BASES & BOARDS

for the above changers

BASES. \$3.89 MOUNTING BOARDS. \$1.95  
12" Alumin. Ball Bearing Phono Slides. .pr. \$1.95

<b>45 RPM SPINDLES</b>	<b>TRIPLE PLAY CART TYPE GE RPX 050</b>
GARRARD .....\$2.99	Reluctance, Triple Play.
WEBSTER .....\$3.89	Dual Sapphire
COLLARO .....\$3.79	Needles..... <b>\$5.79</b>
MONARCH .....\$2.95	

### HI-FI AMPLIFIER

10 Watt Custom Made. Hi-Fi Push-pull 6V6 tubes. From 20 to 20,000 cps. Separate bass & treble control. Built-in Preamp. Completely wired. **\$19.95**

### RECORDING TAPE—TOP NAT'L BRAND

Red oxide plastic base, professional quality, higher performance. 7", 1200 ft., \$1.59 each (lots of 12).

7" Mylar Hi-Fi Tape, 1800 Ft. ....\$4.79 each

7" Mylar Hi-Fi Tape, 2400 Ft. ....\$6.95

### MAJESTIC FM-AM TUNING HEADS

Complete Front RF Section. For FM-AM Receiver. Wired, band switch, tuning condenser. 455 kc AM I.F., 10.7 FM I.F. Fully aligned. Schematic diagram. \$25 value. (Less tubes.) **\$3.95**

All merchandise is brand new, factory fresh & guaranteed. Mail & phone orders filled on receipt of certified Check or 110 of 20% of items as a deposit. Balance C.O.D., F.O.B. factory N. Y. Prices & specifications subject to change without notice.

**AIREX RADIO CORP., 171 Washington St., N. Y. 7 CO 7-5218**

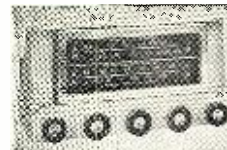

### REGAL FM-AM RECEIVER

Hi-Fi 10 Tubes. Covers full FM-AM band. 10 watt Push-pull audio output. Separate bass & treble controls. Built in FM-AM antenna. Preamp \$7.95 additional. RCA 12" Speaker. ....\$ 4.95  
Coaxial 8" Speaker. .... 9.95  
Coaxial 12" Speaker. .... 12.95

Excellent for use with above chassis.

### R-J Type Hi-Fi Speaker Enclosures

8" Shelf Mdl, unfin, 23 1/2 x 11 x 10 1/2 ..... \$16.95  
8" Shelf Mdl, mahog or blond, 23 1/2 x 11 x 10 1/2 ..... 19.95  
12" Shelf Mdl, unfin, 24 x 21 x 10 1/2 ..... 20.95  
12" Shelf Mdl, mahog or blond, 24 x 21 x 10 1/2 ..... 23.95  
15" Floor Mdl, unfin, 20 x 20 x 15 1/2 ..... 29.95  
15" Floor Mdl, Mahog or blond, 20 x 20 x 15 1/2 ..... 34.95

All cabinets completely assembled with grill cloth and acoustical material. 15" floor models come with 12" adapter board.

### 630-9 30 TUBE 21" TO 27" CHASSIS

High gain cascade tuner • Fringe area control • AGC control • 90° deflection • No drift operation • Channel locks picture & sound together • 18 KV H.V. power supply • Complete with RCA connection & switch • 4 microvolt sensitivity • 12" speaker. Less CRT tube. **\$159.95**

TUBE MOUNTING BRACKETS—\$9.95

### TV PICTURE TUBES

21" .....\$33.95  
24" ..... 49.95  
27" ..... 69.95  
Nationally known Brands. Aluminized. New. 1 Year Guar.

### PLASTIC TV MASKS

1 piece lucite. Gold border. Outside mount. 21" .....\$ 7.95  
24" ..... 14.95  
27" ..... 17.95

### TV CONVERSION KITS

Convert any make TV receiver to a larger picture tube. Complete parts—Cosine deflection yoke, hi voltage flyback. Resistors, condensers, damper tube, brackets. Simple detailed instructions with diagrams.

70° Deflection Kit. For tubes up to 21". **\$13.97**

90° Deflection Kit. For 24"-27" tubes. **\$15.98**

### W. E. POWER AMPLIFIER NO. D162308

3 tube operation, complete with condensers, resistors & chokes, wired. With 6L6, 6SJ7, 6X4GT ruggedized tubes. Tubes list for \$7.75 alone. **\$34.95**

Send for FREE catalog on Hi-Fi amplifiers, tuners, cabinets & enclosures. Send post card to be put on mailing list.

### RED HOT DEAL

100 ALL AMERICAN RESISTORS \$1.25  
72—1/2W, 18—1W, 10—2W.

SEND FOR FREE CATALOG

**CAPITAL ELECTRONICS**  
222 FULTON ST., N. Y., N. Y.

### SCHEMATICS—CONVERSIONS FOR SURPLUS GEAR

NEW LIST D! MANY ADDITIONS!  
Send stamped, self addressed envelope for List D. Add 25c for chart explaining AN nomenclature. DO IT TODAY!  
R. E. BOX 1220  
GOODHEART BEVERLY HILLS, CAL.

## GET INTO ELECTRONICS

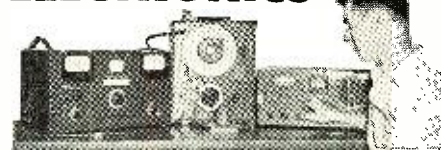

You can enter this uncrowded, interesting field. Defense expansion, new developments demand trained specialists. Study all phases radio & electronics theory and practice; TV; FM; broadcasting; servicing; aviation, marine, police radio, 18-month course. Prepare for good pay. Graduates in demand by major companies. High School or equivalent required. Begin January, March, June, September. Campus life. Write for catalog. **VALPARAISO TECHNICAL INSTITUTE**  
Dept. RD Valparaiso, Indiana



# STAN-BURN EPA-R-K-E

## CATHODE RAY TUBE SPECIALS

### ONE YEAR GUARANTEE

G.E.	Type	STAN-BURN	G.E.	Type	STAN-BURN	
\$13.25	10BP4	\$10.20	\$28.15	17CP4	\$19.50	
18.00	10FP4	14.00	31.25	17GP4	20.75	
16.25	12LP4A	13.95	32.25	19AP4A	22.50	
28.95	12QP4	10.50	27.40	20CP4	18.95	
18.15	12UP4	14.50	33.00	21AP4	22.25	
18.15	14CP4	13.40	33.25	21MP4	23.50	
15.00	15DP4	15.50	27.40	21EP4	21.50	
31.25	16AP4A	16.00	90.75	24AP4	49.00	
26.25	16KP4	15.75	<b>DUMONT TUBES</b>			
31.25	16GP4	18.50	120P4A	23.75	16FP4	26.00
29.00	16LP4	15.25	15DP4	26.55	17KP4	25.00
29.00	16WP4	15.25	16DP4A	31.00	19AP4A	33.25
22.50	17BP4	15.75			21KP4	38.50

PRICES SUBJECT TO CHANGE WITHOUT NOTICE

### PORTABLE RADIOS

JEWEL 5 TUBE SUPER HET AC-DC—Red, Ivory, Walnut, and Ebony..... **\$12.50**  
Same with automatic clock & alarm. IVORY—\$15.95.  
WALNUT \$15.45

### RECORD PLAYERS

Manual 3 speed record player—Single needle...\$14.50  
Manual 3 speed with FLIP-OVER CARTRIDGE...\$16.95  
Automatic 3 speed with VM CHANGER...\$37.50

\$20 WORTH OF ELECTRONIC PARTS IN GRAB-BAG consisting of: Porcelain sockets, coils, speaker, transformers, resistors, condensers, etc. ONLY \$1.98 (plus 50c postage).

TURNER AU PHONO CARTRIDGE—Universal replacement. Low/high output...\$1.59 ea.; 6 @ \$1.49 ea.

VM 3 SPEED HI-FI CHANGER—Model 950 with Ronette Sonotone or Astatic flip-over cartridge—BRAND NEW. ORIGINAL CARTONS.....\$21.49

WEBSTER Model 140—3 SPEED Automatic with Ronette Sonotone or Astatic flip-over cartridge...\$22.45

RCS4 Collora with Ronette flip-over cartridge...\$34.95  
With G.E. plug in RPX050.....\$41.95

TUBE BRIGHTENERS.....69c ea.; 6 for \$3.66

## HALLICRAFTERS

### RADIO • HIGH FIDELITY • TV

MODEL 17TS700M—Table Model Dealer net \$ 88.95  
MODEL 21TS460M—Table Model Dealer net \$129.46

### PORTABLE RADIOS

MODEL TW100—British Tan  
MODEL TW102—Champagne  
MODEL TW103—Cherry Red  
MODEL TW104—Cloud Blue

**\$2980**  
NET

### SONORA RADIOS

4 TUBES—Mahogany, Red, and White. MODELS 524, 525, 526.

MODELS 544-545 in Mahogany and White. CLOCK RADIOS in Mahogany, Red and White. 3-WAY PORTABLES in Maroon and Gold—Model 537.

TELEVISION SETS in 17", 21", 24" TABLE AND CONSOLE MODELS

(WRITE FOR CATALOGS AND PRICES ON ALL ABOVE MODELS)

We Carry a Complete Line of  
Pentron and Crescent Tape Recorders

**DEALERS:** Write for low cost prices and catalogs on '56 models—HALLICRAFTERS, CRESCENT, FANNON, SONORA, WILCOX-GAY, TECHMASTER, C.E., WESTINGHOUSE, TUNG-SOL, OSWALD, TECHMASTER, DELCO, GEN. MOTORS. Address all inquiries to Dept. RN-1.

We invite export inquiries and offers. Our export department will give special attention to expediting foreign orders at minimum commissions. We are authorized distributors for United Motors, all Delco and Gen. Motors Auto Radio parts in stock. We also carry a complete line of popular makes of Radio Tubes at 50/10 discount. Also many other special purpose and transmitting types, and all electronic parts and equipment at lowest prices. Send us a list of your requirements for prompt quotations. Terms: 20% with order. Balance C.O.D. All prices F.O.B., NEW YORK Warehouse. Minimum order \$5.00. Write for our latest price list and Hi-Fi Catalog RN-1.

**STAN-BURN** RADIO and ELECTRONICS CO.  
558 CONEY ISLAND AVE. • B'KLYN 18, N. Y.

ard white, and color television servicing. It provides reproduction of the 3.58 mc. sync burst and 3.58 mc. oscil-

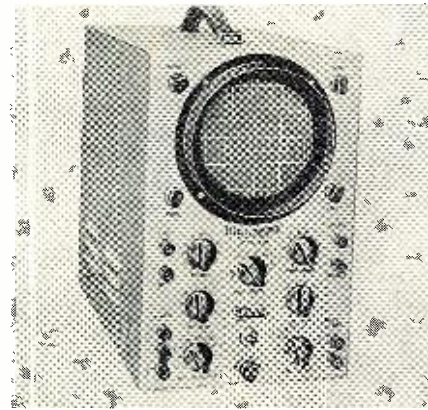

lator signals in color TV sets. Coverage is flat from d.c. to 4.5 mc., usable to above 5 mc.

The unit is supplied with a satin-finished aluminum panel and grey wrinkle steel cabinet. To facilitate calibration, the Plexiglas scale of the #460 is edge illuminated, with a dimmer control provided on the front panel. The illuminated scale is especially convenient for photographing a trace with the scale superimposed.

In kit form, the #460 is supplied with complete step-by-step instructions for assembly and operation.

### JUNCTION POWER TRANSISTOR

To meet the need for a transistor with greater power than those currently available, *Amperex Electronic Corporation*, 230 Duffy Ave., Hicksville, Long Island, N. Y. has just introduced the Type 2N115 *p-n-p* junction power transistor that delivers 5 watts push-pull output with a 6-volt supply.

The transistor has a very high current rating at a low drop across the unit itself, the relationship between the base current and collector current is extremely linear and the gain is exceptionally high for the power level. It is internally insulated from its metal case, so that no external mica insulation is needed when mounting the unit on a chassis. The output impedance is low enough for a 5-ohm speaker voice coil to be used directly as the collector load in the audio output stage, thus eliminating the need for output transformers.

Complete specifications on the Type 2N115 are available from the manufacturer on request.

### LOW-COST POTENTIOMETERS

*Claroostat Mfg. Co., Inc.* of Dover, N. H. has redesigned its "Humdinger," Series MB control, a low-cost potentiometer, to provide an increased range of resistance values from 2 ohms to 15,000 ohms, a gain of 14,000 ohms over earlier models.

In addition, the new version features insulated construction, with the wiper arm insulated from shaft mounting and bushing. An optional feature is the hollow-shaft construction which allows the mounting of a switch at the rear,

# TUBES!!

BRAND NEW  
NEVER USED  
NAME BRANDS



NOW . . . Save more than 50% of distributors' price on thousands of brand new receiving tubes originally destined for use in new equipment. Most of these tubes carry date codes within the warranty period. All are sold with a

ONE YEAR GUARANTEE

## SPECIAL 6AC7.....89¢

2X2 .....	89¢	6SH7 .....	89¢
6AF4 .....	99¢	6SK7 .....	59¢
6AG7 .....	59¢	6V6GT .....	72¢
6AH6 .....	89¢	6V6G .....	42¢
6AK5 .....	82¢	6Y6 .....	58¢
6AQ5 .....	59¢	12AL5 .....	54¢
6CD6 .....	1.29	12AT7 .....	65¢
6CS6 .....	73¢	12AX7 .....	69¢
6DE6 .....	73¢	12AZ7 .....	98¢
6H6 .....	34¢	12SN7 .....	48¢
6K7GT .....	54¢	826 .....	89¢

No Order Too Small. These tubes shipped within 24 hours of receipt of order. 25% deposit required with order. F.O.B. Brooklyn.

**FEDERATED TELEVISION**  
MART, INCORPORATED  
513 Rogers Ave., Dept. RN, Brooklyn 25, N. Y.

## Rid Your Records of Dust

always use

**STATIC masters**  
The Best...The Dry Method



NO SPRAYING  
NO WASHING  
NO RUBBING

Brush while  
record is rotating

The  
Polonium  
Strip does  
the trick

An effective easy-to-use record brush that will pay for itself many times over—in the protection it will give your prized record collection.

**\$1785**

Expensive compared with other products...but inexpensive when noise-free and longer lasting records are considered.

Buy STATICMASTERS at your Hi-Fi dealers or order direct—sent postpaid—cash with order.

**NUCLEAR PRODUCTS CO.**  
10173 E. RUSH ST. • EL MONTE, 2, CALIF.

RADIO & TELEVISION NEWS



with the switch shaft passing through the center of the controls.

These units are especially useful in auto radio, dashlight dimmer, auto speaker, and various test meter applications.

#### PHAOSTRON V.T.V.M.

Phaostron Company, 151 Pasadena Ave., South Pasadena, California has announced the development of a new vacuum-tube voltmeter, the Model "777."

The new unit is a completely self-contained, ready-to-use instrument with all its accessories fitting easily into its genuine leather carrying case. Accessories include a high-frequency coaxial cable, d.c. probe, and a.c. line cord. A 28-page illustrated instruction manual accompanies the instrument.

The Model "777" has illuminated scales, a double-shielded 200 micro-ampere movement, 42 unduplicated ranges, separate range and function

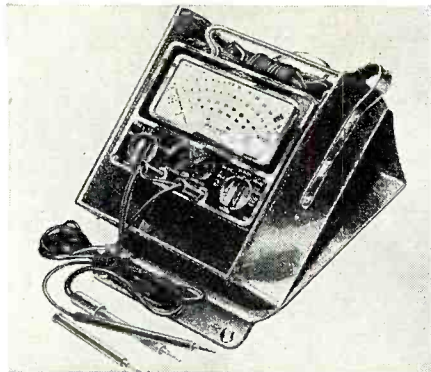

switches, unbreakable metal case, and two jacks which handle all of the measurement functions.

Write the company for full specifications on this new service instrument.

#### TEST SOCKET ADAPTERS

A complete set of test socket adapters, designed to make quick electronic measurements on any TV set chassis has been developed by *General Cement Mfg. Co.*, 400 S. Wyman Street, Rockford, Ill.

Four adapters are included in this kit, which is packaged in a convenient form for use in a technician's kit as well as on his bench. The kit facilitates the measurement of voltage and resistance, audio and video from the top of the chassis or the base of the picture tube. Besides the adapter for use with the CR tube, there is also included a 7-pin and 9-pin miniature test socket adapter and an 8-pin octal socket adapter. Each has extended test tabs, making it possible to use either alligator clips or test prods.

#### AMPLITUDE MODULATOR

*Measurements Corporation*, Boonton, New Jersey has just released an amplitude modulator which has been designated as the Model 115.

Operating over a frequency range of .1 to 50 mc. with external modulation frequencies of 30 cycles to 15 kc., it provides 100% amplitude modulation with low envelope distortion and negli-



# 460

**KIT**  
**\$79.95**

Factory Wired \$129.50

- V amplifier direct-coupled and push-pull thruout; gradual roll-off beyond 4.5 mc; useful at 10 mc.
- High V sensitivity: 25 mv/in.
- Choice of direct coupling (DC) or capacitive coupling (AC).



84 Withers Street • Brooklyn 11, N. Y.

New!  
**COLOR**  
& BLACK & WHITE  
**LAB & TV SERVICE**  
**5" SCOPE**

#### 5 MC BANDWIDTH & DC AMPLIFIERS

- Flat from DC to 4.5 mc to reproduce 3.58 mc sync burst and oscillator signals in color TV sets.
- 4-step freq-compensated attenuator in both AC and DC positions.
- Built-in calibrator permits peak-to-peak voltage measurement.
- Automatically syncs anything visible on the screen.
- Pre-set TV V & H sweep positions (30 cps & 7875 cps).
- Edge-lit lucite engraved graph screen with dimmer control; filter; standard bezel fits standard photographic equipment.
- 5U1 CRT

Write for FREE New 1956 Catalog RS-1 and Name of Distributor

©56 Prices 5% Higher on West Coast

NOW IN STOCK AT YOUR NEIGHBORHOOD DISTRIBUTOR . . . ORDER NOW!

#### for faultless playback and recording!

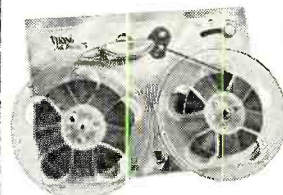

FULL FIDELITY PERFORMANCE  
40-14,000 CPS  
at 7.5 IPS  
(±3db)

from  
**\$59.95**  
USER NET



- Meets broadcast requirements for minimum distortion, flutter and wow.

GENTLE as a LAMB!

Now equipped with a fast forward that will not string or break thin-base tape.



- Available in models equipped with monaural, stereophonic (stacked or staggered) and record-playback heads.

At your Dealers. Write for information.

**VIKING OF MINNEAPOLIS**

Dept. RT-1

3520 E. 43rd St., Minneapolis, Minn.

Distributed in Canada by Musimart of Canada, 901 Bleury St., Montreal.

#### LEARN ELECTRONICS & COLOR TV in K.C.

UNIVERSAL TV . . . Famous for 25 Years  
Thousands of Successful Grads



ELECTRONICS—the world's GREATEST new industry is years ahead of its manpower supply. ELECTRONICS JOBS ARE SEEKING TRAINED TECHNICIANS, an acute shortage of which exists today. Big companies are actually pirating men from one another because there aren't

enough trained electronics experts to go around to fill the many jobs.

#### Wide Scope Electronics Course at UNIVERSAL:

Embraces Radio, Monochrome-Television, Color TV, Industrial Electronics, Industrial Television, Atom-electronics and Automation. Automation, a terrific new field, embraced at UTS.

#### 25 Years EXCLUSIVELY in Electronics:

For a quarter of a century UNIVERSAL TV has been training and placing grad technicians in fascinating big-pay jobs from coast to coast. You can start earning as much as \$150 per week; no limit as time goes on, or you can open your own business.

#### UNIVERSAL not a Johnny-come lately school:

Not a home study or correspondence training, but a "genuine" old established resident school staffed by expert instructors and headed by America's first TV broadcasters. Costs so little to prepare yourself for life. Many middle age trainees attend; go into successful business. No previous experience needed. Approved for vets and non-vets. Send coupon for FREE BOOK on TV & electronic opportunities.

WRITE FOR  
**FREE CATALOG**

--- FILL OUT COUPON ---

UNIVERSAL TV SCHOOL  
1222X Admiral Boulevard, Kansas City, Missouri

PLEASE SEND ME INFORMATION FREE. Age \_\_\_\_\_

Name \_\_\_\_\_

Address \_\_\_\_\_

City \_\_\_\_\_ State \_\_\_\_\_

Check here if Korean Veteran



# DYNAMIC 1956 MODELS

PRECISION ENGINEERED BY



ELECTRONICS

FOR BETTER RECEPTION

TELEVISION & FM ACCESSORIES  
Tested and specifications certified by  
New York Testing Laboratories, Inc.

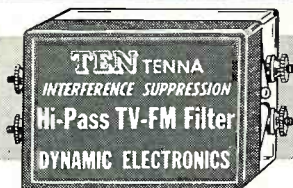

Guaranteed complete suppression and elimination of disturbances in antenna system caused by ignition, diathermy, X-ray, industrial RF, appliances, fluorescence, neon, and transmitters.

- Passes all frequencies above 40 mc.
- Rejects all frequencies below 40 mc.

Model No. T121 List \$6.00  
Introductory Price \$4.95

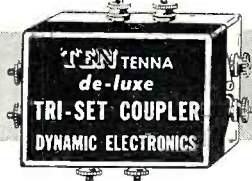

For highly efficient operation of any combination of 2 or 3 TV sets or FM Receivers from 1 Antenna of any type . . . absolutely no interaction.

- Less than 6 db insertion loss.
- 40 to 50 db rejection ratio.

Model No. T130 List \$7.50  
Introductory Price \$5.45

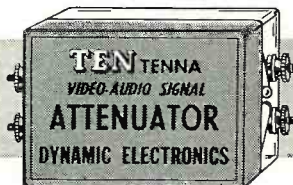

Assures removal of overload in strong signal areas . . . will improve and remedy faulty AGC circuits in TV and FM Receivers . . . regardless of cause.

- Eliminates ghosts and image tearing.
- Reduces audio and video distortion.

Model No. T115 List \$6.00  
Introductory Price \$4.95

SATISFACTION GUARANTEED OR  
YOUR MONEY BACK

**FREE**

An 8-page booklet packed with every "Dynamic" accessory. How to recognize and remedy your TV and FM problems. . . Also improvement suggestions by eminent electronic engineers. . . Edited by Dr. H. S. Bennett, D.S.C. in E.E.

AVAILABLE AT LEADING PARTS DISTRIBUTORS.  
ALREADY IN STOCK AT —

Olson Radio, 275 E. Market St., Akron, Ohio  
Olson Radio, 423 W. Michigan, Milwaukee, Wis.  
Olson Radio, 711 Main St., Buffalo, New York  
Newark Electric, 223 W. Madison, Chicago, Ill.  
Newark Electric, Century Blvd., Inglewood, Calif.  
Mito Electronics, 215 Fulton St., New York, N. Y.  
Chas. Freshman Co., 6610 Euclid Ave., Cleve., O.  
Allied Electric, 1320 W. Erie Ave., Phila., Pa.  
Cramer Electronics, 811 Boylston St., Boston, Mass.  
Electronic Whis., 2345 Sherman Av., N.W. Wash., D.C.  
Slate & Co., 2755 Webster Ave., Bronx, New York  
Bay Electronic, 2712 Avenue U, Brooklyn, N. Y.  
Hudson Radio, 35 William St., Newark, N. J.

Manufactured by

DYNAMIC ELECTRONICS-NEW YORK, INC.  
FOREST HILLS, LONG ISLAND, N. Y.

gible incidental frequency modulation. This instrument is designed for making measurements on systems requiring up to 100% modulation and on



narrow-band receivers where incidental FM cannot be tolerated. It may be used with any conventional AM or FM signal generator and an audio oscillator capable of producing approximately 10 volts across 100,000 ohms. The instrument is housed in a case of modern design and weighs only 15 pounds.

### PORTABLE WORKBENCH

Argos Products Co., 6514 W. Higgins Road, Chicago 31, Illinois has developed a portable workbench for service technicians which has been trademarked the "Quickie Bench."

When folded for carrying, the bench resembles a small, low-height suitcase only 26" x 11" x 6 1/4" thick. It can be set up in less than 35 seconds to give a work surface 26" by 22" by about 25" high. In addition there is a small extension shelf, 9" x 12" on one end for a service meter or tube checker.

The work surface is of hard Masonite. Its wedge-type legs afford great strength and assure wobble-free support throughout the life of the bench.

### POWER RECTIFIERS

A new series of germanium diffused junction power rectifiers is now available in production quantities from Federal Telephone and Radio Company, 100 Kingsland Road, Clifton, N. J.

The rectifiers, 1N91, 1N92, and 1N93, have a reverse current of at least 20

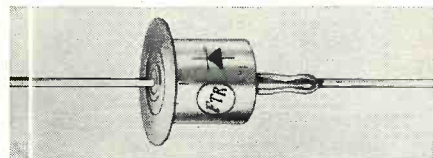

per-cent lower than RETMA specifications for the type. These units are particularly recommended for blocking, magnetic amplifier, and magnetic control applications. They can replace thermionic diodes in computers and, in addition, their low capacitance permits the passage of frequencies up to 50 kc., making them suitable for such uses as carrier-type servo amplifier rectifiers.

### PORTABLE MEGOHMMETER

Freed Transformer Company, 1715 Weirfield St., Brooklyn 27, N. Y. has introduced a battery-operated version of its 1020B megohmmeter for measuring leakage of transformers, motors,

### Recording Tapes—New Low Prices!

ALL BRANDS, 1200 ft. plastic, now list, 3.50, our net 2.28. NEW.  
ALL BRANDS, 1800 ft. 1 mil acetate long playing tapes now list, 5.50, our net 3.30. NEW.  
All H.O. tapes now list 5.50, our net 3.30. NEW.  
New 1/2 mil tape list 12.50, our net 7.45. NEW.  
(Above are all name brands and are not "super bargains" having no manufacturer's name.)  
COMPLETE PRICE SHEET AVAILABLE.

### USED RECORDING TAPE (PLASTIC BASE)

ATTENTION Industrial users: We have the New "MYLAR" tapes from 1/2 mil to 3 mil thickness by Scotch, Geneve, Reeves Audio and Irish. We will buy your present tapes provided there is not more than 1 splice per reel.

1.58 for 7"—1200 foot
.79 for 5"—600 foot
.45 for 4"—300 foot
.25 for 3"—150 foot

★ ★ ★ ★ ★

### USED "MYLAR" TAPE (1 Mil)

300 ft. (3" reel) . . . . .59
900 ft. (5" reel) . . . . .1.44
1800 ft. (7" reel) . . . . .2.89

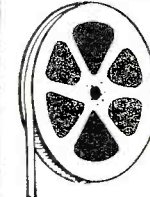

New empty plastic reels in boxes. 3" 10c; 4" 22c; 5" 24c; 7" 29c ea. 10 1/2" fiber-glass Reel \$1.49. EMPTY BOXES: 3" 3c; 4" 5c; 5" 7c ea.; 10 1/2" 25c ea.

"Tape Recording" magazine, 35c (back issues available). Audio Devices 1956 TAPE RECORDING DIRECTORY free. Please include Sufficient Postage

COMMISSIONED ELECTRONICS, INC.  
2503 Champlain St. N.W. Washington 9, D. C.

## Crystals

BUY NOW AND SAVE UP TO 90%

4,000,000  
GOVERNMENT  
SURPLUS  
CRYSTALS

NOVICE, FT-243  
FT-171, FT-241,  
FT-249, DC-34/35  
SHIP BAND, MISC.

SAME DAY SERVICE!

SATISFACTION GUARANTEED!

OVER 5,000 FREQUENCIES!

SEND FOR  
FREE  
CATALOG

"The House of Crystals"

U. S. CRYSTALS, Inc.  
805 S. UNION AVE. • LOS ANGELES 17, CAL.

### Ask For Sprague By Catalog Number

Know what you're getting . . . get exactly what you want. Don't be vague . . . insist on

Sprague. Use complete radio-TV service catalog C-610. Write Sprague Products Company, 51 Marshall Street, No. Adams, Mass.

**DON'T  
JUST SAY  
CAPACITORS**

**SPRAGUE**  
WORLD'S LARGEST CAPACITOR MANUFACTURER



cables, capacitors, and insulating materials wherever a power line is inaccessible or where battery operation is more desirable.

The Model 2030 portable megohmmeter measures leakage resistance from 5 megohms to 10,000,000 megohms in 5 ranges with an accuracy of  $\pm 3\%$ . A regulated 500 volt supply is incorporated in the instrument.

#### TRANSISTORIZED VOLTMETER

A new portable voltmeter covering frequencies from 20 cps to 1 mc. has been developed by *Alto Scientific Company*, 855 Commercial Street, Palo Alto, California.

The Model D-21 is battery powered, is housed in a 5" high plastic case, and



weighs only 30 ounces complete. The instrument is transistorized and uses printed circuits for maximum ruggedness, dependability, and uniformity. Peak sensitivity is 0 to 1 millivolt and any of 12 decade (10 db) ranges may be switched on the front panel. A 10 megohm input impedance on all ranges prevents disturbances to circuits under test.

#### IMPROVED FILAMENT CHECKER

*Service Instruments Company*, 171 Official Road, Addison Industrial District, Addison, Illinois has announced a new version of its *Senco* filament



checker for locating the open filament in the new series filament TV sets.

The Model FC 4 is pocket sized and automatically checks all octals, loctals, 7- and 9-pin miniature tubes and picture tubes. The unit can also be used as a continuity checker and neon voltage indicator by merely inserting standard test leads in pins 1 and 12 of the picture tube socket.

-30-

January, 1956

**INDEPENDENT SCIENTIFIC SURVEY**

**AND LAB TESTS PROVE**

**PRECISE MODEL #111---"BEST**

**COMMERCIAL TUBE TESTER**

**AT ANY PRICE"...**



Now You Can Check Tubes  
The Manufacturer's Way

- Checks both emission and mutual conductance
- Checks all tubes including hearing aid, miniatures
- Six different plate voltages
- Different grid signals
- Simplified Short check
- Gas check
- New type switches
- Deeply etched aluminum panel
- Three different screen voltages
- Latest roll chart
- Measures filament current
- Measures grid bias

**precise**  
Model #111

111K (kit form) **NOW ONLY \$69<sup>95</sup>**  
111W (factory wired) ..... \$139.95

### Mutual Conductance and Emission TUBE TESTER

An independent scientific survey conducted by an impartial testing laboratory confirms what purchasers already know: "The most advanced, the most complete tube tester and the best priced is made by PRECISE DEVELOPMENT CORP., Oceanside, N. Y."

**CHECK THESE ADDITIONAL 'specs' ... TALK TO YOUR JOBBER AND TO ANYONE WHO HAS THIS OUTSTANDING TUBE TESTER...**

The Model 111 is the only single commercial tube tester that checks all tubes for both EMISSION and MUTUAL CONDUCTANCE separately. Filament current is measured directly on large meter when checking a VOLTAGE TAPPER tube. NEW, MODERN DESIGNED ROTARY SWITCHES allow you to check each tube element individually. NEW TYPE Single Rotary switch for complete short checks. The 111 makes all BIAS,

FILAMENT VOLTAGE, GAS, LIFE checks visually on large meter ... 5 individually calibrated ranges and scales for mutual conductance tests. NEWLY DESIGNED "NO BACKLASH" ROLL CHART lists all tubes including the new type 600 mil series tubes. Provisions are made for testing many color tubes. All CRT's can be checked with accessory adaptor, Model PTA.

For Information on where to purchase this and other Precise "Bests", see your local jobber or write —

**precise DEVELOPMENT CORP., OCEANSIDE, NEW YORK**

**HOT! FREE! NEW!**

- ★ 1956 Flyer
- ★ Loaded with Hi-Fi
- ★ & Surplus Bargains!

Get your **FREE** copy today!

**ARROW SALES, INC.**

Box 3878-R North Hollywood, Cal.

### ELECTRONICS



Prepare for **ENGINEERING DEGREE**  
unlimited opportunities in **27 MONTHS**

of the Electronic Age! Earn your B.S. degree in 27 months at Indiana Technical College. Intensive, specialized course. Comprehensive training in math and electrical engineering, advanced radio theory and design, television, electronics. Modern laboratories. Low rate. Also B.S. DEGREE IN 27 MONTHS in Aeronautical, Chemical, Civil, Electrical and Mechanical Engineering. G.I. approved. Enter March, June, September, December. Earn part of your expenses in Fort Wayne while studying. Write for catalog. Please send me free information on B.S. ENGINEERING DEGREE IN 27 MONTHS as checked.

**INDIANA TECHNICAL COLLEGE**

916 E. Washington Blvd., Fort Wayne 2, Indiana

- |                                     |                                     |                                       |
|-------------------------------------|-------------------------------------|---------------------------------------|
| <input type="checkbox"/> Electronic | <input type="checkbox"/> Chemical   | <input type="checkbox"/> Aeronautical |
| <input type="checkbox"/> Civil      | <input type="checkbox"/> Mechanical | <input type="checkbox"/> Electrical   |

Name .....  
Address .....



THE SMALL  
SPEAKER SYSTEM  
with the  
**BIG, ALMOST  
PERFECT  
SOUND**

*Absolutely amazed all ears at  
the 1955 N. Y. Audio Fair*

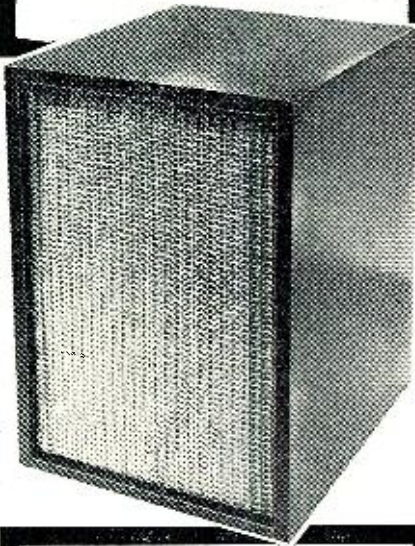

- a specially plasticized cone edge lowers the resonant frequency of the cone providing fuller bass
- direct radiation of highs
- complete use of backwave gives higher efficiency
- lengthened air column simulates big speaker performance
- individually tuned port
- smooth response 45 to 15,000 cps with extremely low distortion
- no audible frequency doubling
- excellent transient response
- rigidly constructed and thoroughly braced cabinet, 15" high, 10½" wide, 12¼" deep
- impedance 8 ohms, power rating 16 watts

*Truly a matchless speaker system for critical listening. An excellent additional unit for use in that other room or for binaural installations.*

(PR-1M) only  
in mahogany finish, complete with all cable and ready to attach to your amplifier.

**34<sup>50</sup>**  
(delivered)

at your  
dealer  
or direct  
from



361 Bleecker St., New York 14, N. Y.

# RADIO-TV Service Industry News

## AS REPORTED BY THE TELEVISION TECHNICIANS LECTURE BUREAU

RECENTLY, the second meeting of the Electronic Service Council for National Unity was held in Indianapolis, Ind. The Council was formed early in August by association delegates meeting in Pittsburgh, Pa., for the purpose of bringing together all of the factions of the electronic service industry to determine whether the differences between the several groups could be resolved and a single national association created that would embrace all of them. It was decided at the Pittsburgh meeting that, to be successful and effective, a single national association must be representative of all elements of the electronic service industry. This would include shop owners, servicing dealers, and technicians. It was also the opinion of the delegates to the Pittsburgh meeting that an "umbrella" type of organization would be necessary to handle the integration of the several national and state groups into a single national association.

Prior to the Indianapolis meeting, most of the delegates felt that it would provide an opportunity for an open-minded exchange of ideas. Many looked forward to discussions of association programs that are currently successful as a means of appraising the changes that should occur in the direction of association affairs to take advantage of the best elements of the successful plans.

Following the procedure recommended by the Pittsburgh conference, the second meeting was opened by Bert Bregenger of Pittsburgh, president of the Federation of Radio-TV Service Associations of Pennsylvania. After the reading of the minutes of the Pittsburgh meeting by Gordon Vrooman of Syracuse, N. Y., secretary pro tem of the conference, the chairman invited nominations for a new chairman to preside at the Indianapolis meeting. In a skillfully executed maneuver, Joseph A. Barg, a professional trade association executive from Cincinnati, executive director of ATSCO, the NATESA affiliate in that city, was elected chairman of the meeting. Mr. Barg had been presented to the delegates as an attorney and a competent parliamentarian who would follow the basic principles of parliamentary law.

Shortly after the Indianapolis meet-

ing started, the chairman of the meeting threw parliamentary law and procedure out the window. After brief presentations of the Texas Electronics Association plan of organization by Forrest Baker, president of the T. E. A.; the new NATESA plan for national organization by Frank Moch, president of that association; the United Nations plan by Max Liebowitz, president of ARTSNY and ESFETA; and the MINTSE plan by John Hemak, president of the Minnesota State Association, Mr. Barg led the meeting into a discussion of how the various associations could join NATESA, freely injecting his own opinions and, at times, confining the proceedings to two-way discussions between himself and Mr. Moch. A motion by Max Liebowitz of New York to form an entirely new national association was tabled by the chairman. The confusion of the proceedings led Murray Barlowe, president of the RTG of Long Island, to tell the chairman, "There is something going on here that I do not understand."

Late in the afternoon the chairman called for a meeting between Mr. Moch and a delegate from each state. This meeting led to the development of a resolution to the effect that delegates would present to their constituents a proposal that they join NATESA and make any desired changes in the organization at the Spring meeting of NATESA in Omaha, Nebraska. This motion was later adopted unanimously by voice vote of the entire delegation.

### State Associations

On the heels of their third and most successful annual electronics fair and clinic, the Texas Electronics Association is formulating a plan to encourage the formation of local associations in all sections of the Lone Star State. At the third annual clinic, held in San Antonio, Texas, outstanding authorities in the technical and business operating aspects of service passed along a wealth of information in the carefully-planned and skillfully-managed clinic sessions.

With three years of successful experience behind them, the officers of the Texas Electronics Association are already working on the details of the 1956 Electronic Clinic and Fair which will be held in Houston, Texas. The keen rivalry between the host cities.



Fort Worth, Dallas, San Antonio, and Houston, which rotate the meetings, will spur the Texas Electronic Technician's Association of Houston, host organization for the 1956 affair, to surpass the records established in the other three cities.

A number of associations met recently in San Francisco, Cal., to form the Television Service Betterment Committee of California. The aims of this committee are to educate the public, to present a stronger front to distributors, to promote an adequate State Licensing bill, and to put the "illegitimate" service shops out of business.

The following associations banded together to form the Television Service Betterment Committee of California: Radio & TV Association of Santa Clara; TV-Electronics Association of Marin; San Francisco TV & Radio Service Guild; Central Valley TV Service Association; Sonoma Radio & TV Association of Contra Costa; Tri-County Radio & TV Association; Radio & TV Dealers Association of Sacramento; San Joaquin Radio & TV Association; and the Bureau of Home Appliances of San Diego. Associations are being formed in Vallejo, Napa, Eureka, and Bakersfield.

The Indianapolis Television Technicians Association has taken the lead in inviting other associations in the State to meet in Indianapolis for the purpose of discussing the formation and organizational structure for a State-wide association. Invitations were sent to associations in Anderson, Muncie, Fort Wayne, South Bend, Elkhart, Gary, Logansport, Lafayette, Columbus, and Evansville. Other Indiana associations interested in a State-wide association have been invited to contact Robert M. Sickels, president, ITTA, 1859 South East Street, Indianapolis, Indiana.

The several active local associations in the State of Missouri met in Jefferson City during October to form the Television Electronic Service Association of Missouri. Jack Mulford of Springfield, Missouri, was named chairman of the new group; Howard Siegen of Kansas City was elected treasurer, and William Pryor of Mountain Grove was given the post of secretary.

The group voted to become an affiliate of NATESA and appointed committees to draw up its constitution and bylaws. The next meeting of the forming association is scheduled to take place January 25 in Jefferson City.

The Television Service Association of Oklahoma, a State-wide group, was recently formed with H. O. Eales as president; Floyd E. Banks, Ed Cones, and Raymond Selby, vice-presidents; William S. Jones, secretary-treasurer; and Bob Armstrong, executive secretary.

Oklahoma service operators who are interested in this new development may get information by writing to the executive secretary at P. O. Box 9664, Shartel Station, Oklahoma City 18, Oklahoma.

The several Ohio associations represented at the national unity meeting discussed the project of calling a State-

## NEW STOCK OF PRE-TESTED TELTRON TUBES GUARANTEED! . . . LOWEST PRICES EVER!

All tubes individually boxed . . . unconditionally guaranteed for one year!

**GIFT OFFER!**  
One 6BG6G tube will be shipped FREE with any order of \$10 or more accompanying this ad.

We have thousands of tube types too numerous to list here. On ordering types not listed take 75% off current list price for cost of tube.

**FREE  
Bonus Offer!**



MODEL 625K

May be bought outright from Teltron for \$34.95

This Eico Tube Tester is yours FREE when you buy \$199 worth of tubes or more within 60 days at Teltron.

We now have a full stock of T.V. picture tubes.

You can order any size at \$1.25 per inch.

All tubes RCA licensed and guaranteed for one year.

Type	Price	Type	Price	Type	Price	Type	Price
02A	.45	6AX5GT	.60	6S17	.45	12SK7	.45
1A7GT	.53	6BA7	.58	6SN7GT	.60	12SL7	.60
1B3GT	.62	6BC5	.48	6SQ7	.40	12SN7GT	.56
1H5GT	.51	6BC7	.75	6T8	.71	12SQ7	.38
1L4	.51	6BE6	.46	6U8	.76	14A7	.43
1L6	.51	6BF5	.48	6V3	.80	14B6	.36
1LC6	.49	6BF6	.48	6V6GT	.48	14Q7	.52
1N5GT	.51	6BG6G	1.18	6W4GT	.43	19B6G	1.48
1R5	.51	6BH6	.51	6W6GT	.53	19T8	.71
1S5	.43	6BJ6	.51	6X4	.37	25L6GT	.82
1T4	.51	6BK5	.75	6X5GT	.38	25B6GT	.41
1U4	.51	6BK7	.78	6X8	.80	25W4GT	.43
1U5	.43	6BL7GT	.78	6Y6G	.61	25Z5	.55
1X2	.65	6BN6	.90	7A8	.46	25Z6GT	.36
3A5	.65	6BQ6GT	.83	7C5	.44	35A5	.48
3Q5GT	.61	6BQ7	.85	7F7	.59	35B5	.48
3S4	.48	6BY5G	.60	7F8	.77	35L6GT	.41
3V4	.48	6C4	.41	7N7	.52	35W4	.42
5R4	.95	6C5	.46	12A7E	.37	35Y4	.42
5V4	.49	6CD6G	1.63	12A7	.71	35Z3	.41
5Y3	.30	6CU6	.95	12A7U	.58	35Z5GT	.33
5Y4G	.37	6D6	.59	12AV6	.42	37	.59
6A8	.40	6E5	.60	12AV7	.73	43	.55
6AB4	.43	6F5	.44	12AX4GT	.60	45	.55
6AC7	.65	6F6	.42	12AX7	.61	50A5	.49
6AG5	.52	6H6	.50	12A27	.61	50B5	.48
6AH4GT	.65	6J5	.49	12B4	.72	50L6GT	.50
6AF4	1.02	6J6	.61	12BA6	.46	50X6	.53
6AK5	.96	6K5	.60	12BA7	.58	75	.44
6AL5	.43	6K6GT	.39	12BE6	.46	77	.55
6AQ5	.48	6K7	.40	12BH7	.61	80	.40
6AR5	.48	6L6	.78	12B7	.65	84	.46
6AS5	.52	6Q7	.40	12H6	.50	117GT	1.20
6AU5GT	.60	6S4	.41	12J5	.40	117L7GT	1.20
6AV5GT	.60	6S8GT	.65	12K7	.40	117N7GT	1.20
6AV6	.37	6SA7	.45	12Q7	.48	117Z3	.33
6AX4GT	.60	6SA7	.45	12S47	.45	117Z6GT	.65
		6SK7	.45	12S7	.45	1629	.39

**FREE!** \$7.20 list value Bonus Box of three 6SN7 tubes and 25 assorted resistors with each order of \$25 or more.

### SAME DAY SERVICE

48 Hour Postal Delivery To West Coast

### NEW LIBERAL TERMS

NO MINIMUM ORDER. ALL POSTAGE PAID ON ORDERS OVER \$10.00 IN U.S.A., A.P.O.'S AND TERRITORIES. 10% DEPOSIT ON C.O.D.'S TO OUR CANADIAN AND FOREIGN FRIENDS. PLEASE SEND APPROXIMATE FREIGHT. EXCESS WILL BE REFUNDED. ORDERS SUBJECT TO PRIOR SALE.

### WE WANT NEW ACCOUNTS

If you are rated, your credit is good with us.

Send for Free complete tube listing and monthly specials! Get on our mailing list.

We are "Eico" distributors. Write us about special deals on test equipment.

### SPECIALS TO JAN. 1ST

REPEATED BY  
POPULAR DEMAND

Specials to Feb. 1st

TYPE	REG. SPEC.	TYPE	REG. SPEC.
1X2	.65	6SN7GT	.60
5U4G	.43	6W4GT	.43
6AC7	.65	12A7	.71
6AU6	.43	12A7U	.58
6AL5	.43	12SA7	.45
6BQ6GT	.83	12SK7	.45
6CB6	.51	12SQ7	.38
6CD6G	1.63	50L6GT	.50

# TELTRON ELECTRIC COMPANY

428 Harrison Ave.,

Harrison, N. J.

Dept. RN-1

Phone HUmboldt 4-9848

### MINIATURE HAND CRANK GENERATOR

Latest type, light weight. From recent model field phone. Many uses. Brand new. Terrific buy!

**FREE!** On request, with every purchase of \$3.00 or more, one J-51 Hand Code Key!

**\$1.49**

### COMMAND TRANSMITTERS

2-3 MC. Good condition . . . \$ 4.95  
3-4 MC. Good condition . . . 4.95  
4-5 MC. Good condition . . . 3.95

ARB REC'V'R. 190 Kc-9.5 MC. Good cond. . . 14.95  
1-222 SIGNAL GENERATOR MICRO-VOLTER  
Freq. range: 3-15 MC. and 150-230 MC. Complete with all tubes and 5 MC. calibration crystal. Self-contained 110V. 60 cye. power supply.

Good condition . . . \$19.95  
CATALOGUE NO. 105 IS OFF THE PRESS!

Get your free copy today!

All items F.O.B. L.A. Prices subj. to change without notice. Calif. buyers add tax. Send 25¢ deposit with C.O.D. orders.

J. J. GLASS ELECTRONICS CO.  
1615 S. Main St. Los Angeles 15, Calif.



### wanted career men

Train for a career instead of a job. Demand for our graduates exceeds supply. Effective placement. Modest costs. Small classes. Well-equipped labs. Beautiful campus. Approved for Vets. Enter March, June, Sept., Jan.

### Bach. Sci. degree in 27 months

Complete Radio Eng. courses . . . TV, UHF, FM, Electronics. Also Mech., Civil, Elec., Chem., Aero. Eng. 36-month B.S. in Bus. Adm. (Gen. Bus., Acctg., Motor Transport Mgt.) . . . capable students faster. Prep courses. Write Jean McCarthy, Dir. Adm., for catalog and "Your Career in Engineering & Commerce."



## TRI-STATE COLLEGE

1616 College Avenue, Angola, Indiana



# TROLMASTER

**CLEANS**  
**AND**  
**LUBRICATES**  
**TV-RADIO**  
**CONTROLS**  
**IN**  
**60**  
**SECONDS**



Now you can completely clean and lubricate volume, tone, brightness and contrast controls without removing chassis or back from cabinet. Simply remove knob at front of control, screw solvent-loaded TROLMASTER onto control, push the plunger in, remove TROLMASTER, work the control back and forth and the job is done—in 60 seconds or less! TROLMASTER thoroughly cleans either single or dual controls. Constructed of solid brass, TROLMASTER will not corrode when used with any chemical normally used in the electronics industry. User's Net, **\$3.95**

**KLEENTROL MAGIC SOLVENT**  
 Cleans, lubricates TV-Radio controls and tuner, push-button and switch contacts. Non-inflammable. Will not harm surfaces or finishes of wood, metal or acetate. Recommended for use with TROLMASTER. Full Pint. User's Net, **\$1.95**

See your Distributor or write.

Manufactured by

**R-COLUMBIA**  
**PRODUCTS CO., INC.**  
**HIGHWOOD, ILLINOIS**

Export Agents: COMTRAD CORP.  
 673 Broadway New York, N. Y.

wide meeting in Columbus to explore the possibility of forming a State group. In a previous meeting, members of the Associated Radio-Television Service Dealers of Columbus and the Television Service Guild of Dayton had agreed to work together to bring about such a meeting.

Ohio associations interested in discussing a State association should contact Fred Colton, Graham & Colton, 2552 North High Street, Columbus.

The Associated Radio Television Servicemen of Chicago have been encouraging the formation of local associations in other cities in downstate Illinois. Several new groups have been formed with the cooperation of ARTS officials. Illinois service technicians who are interested in assistance in forming local associations should write to Howard J. Wolfson, chairman, ARTS, 433 South Wabash Avenue, Chicago, Ill., for information.

The Minnesota Television Service Engineers, Inc., has developed some excellent basic material for association use that can be studied with profit by all groups working on the formation of State associations. One very important factor in the orderly development of electronic service into a recognized professional activity, is the development of nomenclature and standards for the classification of individual technicians on the basis of their knowledge, training, experience, and skills.

Details of the MINTSE program of technician classification and identification can be obtained from John W. Hemak, president, MINTSE, P. O. Box 42, Minneapolis 21, Minnesota.

### Price Fixing

Many service associations do not seem to be aware of the illegality of standard schedules of labor pricing developed by associations for the use of their members. The following news item from the "Yardstick," house organ for the Kansas Appliance Dealers Association, is indicative of the attitude that may be taken by federal judges in interpreting violations of the Sherman Act:

"Many times we are asked why the association does not do this or that. Most recent of these questions has been: 'Why doesn't the association issue a chart of suggested prices for television service?' The following article from the 'American Trade Association Executive News Letter' will throw considerable light on the dangers involved in recommending, suggesting, or publishing standard charges as an association project:

'Preparation by a trade association of a 'suggested' price list can constitute unlawful price fixing even in the absence of evidence that members of the association agreed to follow the price list, or did so, a federal district court in Kansas has ruled.

'The association, composed of companies renting trailers for attachment to automobiles for one-way, single-trip use, prepared a schedule of suggested rental rates. The court's opinion de-

## HI-FI and LP BUYERS CHOOSE AUDIO UNLIMITED

- ✓ We ship PREPAID and INSURED
- ✓ FAST, PROMPT, COURTEOUS service
- ✓ BRAND NEW STOCK—FACTORY SEALED
- ✓ FREE LP CATALOG with ORDER only
- ✓ FREE—on ORDERS of \$50.00 or MORE—A Genuine Diamond Stylus of Your Choice List \$27.50

### SPECIAL

**COLUMBIA FAMOUS DUAL SPEAKER—PUSH-PULL MODEL 360, in Blond or Mahogany Veneers. RONETTE FLIP CARTRIDGE with DIAMOND LP STYLUS. List \$147.50. YOUR COST \$99.50 PREPAID IN U.S.A.**

H. H. Scott - Fisher - Pilot - Pentron - Harman - Kardon - Bozak - Rek-O-Kut - Telefunken, etc. RCA - Columbia - Angel - Capitol - Decca, etc. Dept. N-1

**AUDIO UNLIMITED Inc.**  
 169 W. 57 St., N. Y. 19, N. Y.  
 DIRECTLY OPPOSITE CARNEGIE HALL

### NOW IN STOCK at Howard Electronic Sales

4140 Archer Ave. Chicago 32, Ill.  
 Cliffside 4-1777



**COLOR & BLACK & WHITE**  
**5" — 5 MC SCOPE**

**KIT \$79.95 Wired \$129.50**



#460

## EASY TO LEARN CODE

It is easy to learn or increase speed with an Instructograph Code Teacher. Affords the quickest and most practical method yet developed. For beginners or advanced students. Available tapes from beginner's alphabet to typical messages on all subjects. Speed range 5 to 40 WPM. Always ready—no QRM.



### ENDORSED BY THOUSANDS!

The Instructograph Code Teacher literally takes the place of an operator-instructor and enables anyone to learn and master code without further assistance. Thousands of successful operators have "acquired the code" with the Instructograph System. Write today for convenient rental and purchase plans.

## INSTRUCTOGRAPH COMPANY

4711 SHERIDAN ROAD, CHICAGO 40, ILLINOIS

### ASK FOR SPRAGUE BY CATALOG NUMBER

Know what you're getting . . . get exactly what you want. Don't be vague . . . insist on Sprague. Use complete radio-TV service catalog C-610. Write Sprague Products Company, 51 Marshall Street, North Adams, Massachusetts.

**DON'T JUST SAY  
 CAPACITORS  
 SAY**

**SPRAGUE®**

WORLD'S LARGEST CAPACITOR MANUFACTURER

RADIO & TELEVISION NEWS



scribes the evidence as to this rental schedule as follows:

"As regards to the above referred-to price list, the evidence was and it is specifically found as a fact that the members of the NRTS did not strictly adhere to the price list. Nor was there any punishment ever inflicted for deviation. In fact, no evidence of any agreement to adhere to the price list was introduced. The price schedule was adopted by the association. The schedule itself was referred to by the defendants as a 'suggested' price schedule. The extent of the agreement concerning the price list was that it be circulated to all members. Several witnesses characterized the price list as a guide, 'something to go by.' The Court is unable to find that the price list was circulated for no purpose at all. . . . The Court concludes that the publication, adoption, and circulation of the schedule, while not fixing a rigid price, was such tampering with prices as is forbidden by the Sherman Act.

"Not directly mentioned by the Court is the fact that the restraint on competition is even harder to find because the members of the association did not compete with each other, there being only one at each locality."

### PHOTO CREDITS

Page	Credit
41	Regency Division, I.D.E.A.
50, 51, 100	Sylvania Electric Products Inc.
58, 59, 142	Thomas A. Edison Foundation
60	Hickok Electrical Instrument Co.
74	Custom Records, Inc.
87	RETMA
88, 89	Pilot Radio Corp.
104	General Electric Co.
105	U. S. Army Photograph
120	Heath Co.

### ERRATA

On page 67 in the October, 1955 issue, rectifier filaments (5Y3) in the article, "The 'Minipack' #1" should be 2 and 8 instead of 2 and 7. Also, the sixth line, third column, "pin #7" should be "pin #8".

Also on page 67, column 1, the paragraph above "Construction Details," there are three references to 0.3 ampere. These should all refer to 0.15 ampere instead.

In the article, "A 13-Watt All Triode Infinite Feedback Amplifier," page 69 in the November, 1955 issue, the vertical lead connecting the left end of R<sub>13</sub> to the lead running up to the junction of R<sub>3</sub> and R<sub>1</sub> should be deleted.

On page 71 of the November, 1955 issue (the third line from the bottom, first column, "The 'Minipack' #2"), the correct reading should be "half-wave" rather than "full-wave."

The 15th line from the bottom of page 191, (November, 1955 issue, "Making Use of Load Lines"), (R<sub>2</sub> × R<sub>1</sub>)/(R<sub>2</sub> × R<sub>1</sub>) should be (R<sub>2</sub> × R<sub>1</sub>)/(R<sub>2</sub> + R<sub>1</sub>).

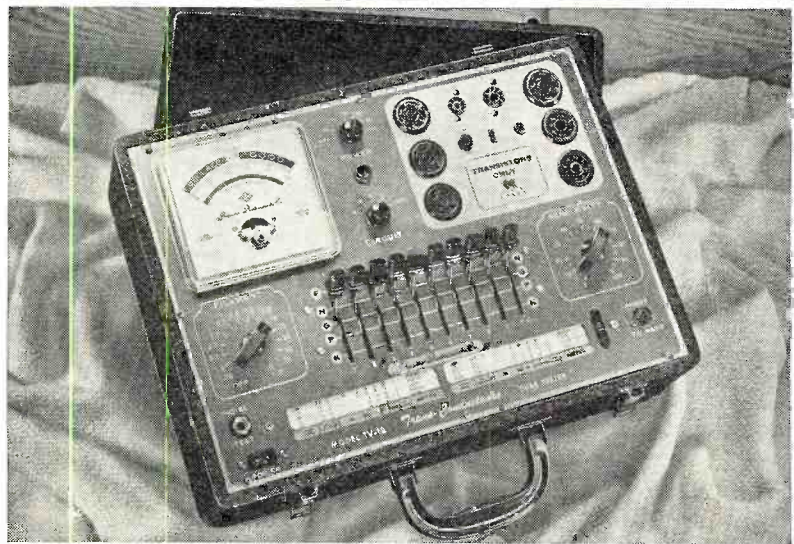

## TRANS-CONDUCTANCE TUBE TESTER

### Also Tests Transistors

• Employs improved TRANS-CONDUCTANCE circuit. An in-phase signal is impressed on the input section of a tube and the resultant plate current change is measured. This provides the most suitable method of simulating the manner in which tubes actually operate in Radio & TV receivers, amplifiers, and other circuits. Amplification factor, plate resistance and cathode emission are all correlated in one

meter reading.

• SAFETY BUTTON — protects both the tube under test and the instrument meter against damage due to overload or other form of improper switching.

• TESTS ALL TRANSISTORS — including NPN's, PNP's, Photo, Tetrodes, etc. Transistor quality is read on separate meter scale.

Model TV-12 comes housed in rugged portable case. Complete with all instructions — Only **\$7250** NET

Now at your local radio parts jobber.



**SUPERIOR INSTRUMENTS CO.**  
2435 White Plains Road, R.N-1 New York 67, N. Y.

Live Music...  
direct from Europe

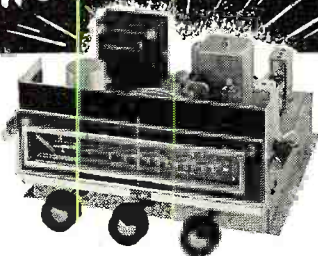

Symphonies, music festivals, operas, folk music — hear them in your own home with the only shortwave tuner designed for your hi-fi system. Plus superb AM standard broadcast!

- Sensitivity 1 to 2 microvolts
- Tape reorder output
- Complete international shortwave and AM standard broadcast bands
- Volume control with ON-OFF switch; AM-sharp, AM-broad selectivity; velvet tuning control
- Compact size, yet has every fine performance specification

Write today for catalog and list of shortwave programs.

**BROWNE L-500 . . . \$8750**

**browning** LABORATORIES, INC.  
750 Main Street, Winchester, Mass.

Export Div., 25 Warren St., New York, N. Y., U. S. A.  
CABLE: SIMONTRICE

## free! ALLIED'S

### SPECIAL 100-PAGE

## HI-FI CATALOG

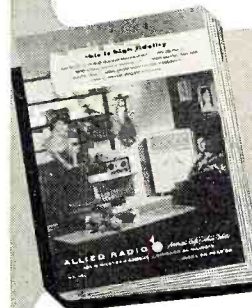

Your guide to an easy understanding of Hi-Fi—plus the world's largest selection of Hi-Fi systems and components

Send for it

This leading 100-page book shows you how to select a Hi-Fi music system at lowest cost. Tells you what to look for in each unit; shows many handsome, practical installation ideas. Offers you the world's largest selection of complete systems and individual units from which to make your money-saving choice. To understand Hi-Fi, to own the best for less, you'll want this invaluable catalog. It's FREE—write for your copy today.

### ALLIED RADIO

America's Hi-Fi Center

ALLIED RADIO CORP., Dept. B-16  
100 N. Western Ave., Chicago 80, Ill.

Send FREE High Fidelity Catalog

Name \_\_\_\_\_

Address \_\_\_\_\_

City \_\_\_\_\_ Zone \_\_\_\_\_ State \_\_\_\_\_





**WRITE FOR OUR BARGAIN "TABOGRAM"**  
A Free Bonus with Every Order

**NEWLY IMPORTED "TAB" POCKET AC-DC MULTITESTER**  
1000 Ohms Per Volt

Only **\$7.85 ea.**  
(Not a Kit)

Model 27C Hi-accuracy precision VOM. Reads AC & DC Volts: 0.5, 25, 250, 1000V. DCMA: 0.1, 1, 10, 100MA. OHMS: 0.1, 1, 10, 100K. Size 1 1/4" D. 4 5/8" L. 3 1/4" W. With test leads plus 40¢ ship. (U.S.A.)

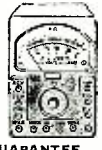

**SOLD WITH "TAB" MONEY BACK GUARANTEE**

**SNOPERSCOPE, Infra Red Tube, . . . \$3.90; 2/57.50**  
Photoflash Cond—525 MFD/450V/53 w/seed, new low leakage. Famous mfr. . . . \$8.25; 2/515

**PRECISION RESISTORS—1% ACCURACY**  
10 OF ONE VALUE . . . . . EA. **10¢**  
10 ASSORTED VALUES @ \$4.00  
COND—AMFD/120VDC or 10MFD/600VDC @ \$1.79 ea.  
Special lots of 12 (any assortment) . . . . @ \$1.25 ea.

**NEW "TABTRON" SELENIUM BRIDGE RECTIFIERS**  
Dated & One Year Gtd

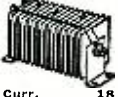

We manufacture Power Rectifiers to your specifications from 1 Amp up to and above 1000 Amps. Following List. **FULL WAVE BRIDGE.**

Curr. Cont.	18/14 Volts	36/28 Volts	52/42 Volts	130/100 Volts
1AMP	\$1.80	\$2.70	\$4.00	\$9.45
2AMP	2.40	3.40	6.15	11.50
3AMP	3.45	4.75	6.70	14.65
4AMP	4.45	6.45	13.25	28.45
6AMP	5.10	10.05	14.75	36.80
10AMP	7.50	14.35	22.40	47.55
12AMP	12.00	18.10	27.40	50.85
20AMP	15.00	28.80	42.80	90.25
24AMP	18.40	36.74	51.15	97.75
30AMP	21.70	38.40	64.95	121.35
36AMP	28.45	54.60	74.75	154.10
50AMP	33.90	62.50	115.95	200.10

Write For Our New Rectifier Catalog PR15

**"TABTRON" HI CURRENT PWR SUPPLY**  
One Year Guarantee

Variable 0-28VDC. Completely Built. Incls.: Full Wave Selenium Rectifier, Transformer, Variac, Volt & Amp Meters, Switch, Terminals & Fuse. 1000 Hvy. duty Steel Cabinet, Standard 115V/60 Cy Input or 220+ and 3 phase to order. **SPOT BUY.**

Stk No.	Cont. Rating	W-Meters
T28V5A	0-28 VDC at 5 Amp. . . . .	\$ 50
T28V12A	0-28 VDC at 12 Amp. . . . .	\$125
T28V24A†	0-28 VDC at 24 Amp. . . . .	\$155
T28V50A†	0-28 VDC at 50 Amp. . . . .	\$285



**1st Quality • Individually Boxed TUBES FULL RETMA WARRANTY**  
No Electrical or Mechanical Rejects  
\*\* OUR 12th YEAR IN BUSINESS \*\*  
Never A Dissatisfied Customer

024	.45	6AV5	.80	6K6	.45	12AX7	.55
1A2	.95	6AV6	.45	6X4	.45	12BA6	.50
1B3	.65	6AX4	.80	6SA7	.50	12BE6	.65
1R5	.50	6AX5	.75	6SJ7	.65	12BH7	.65
1T4	.50	6A6	.65	6SK7	.55	12BY7	.67
1U5	.45	6B5	.60	6SL6	.55	12SA7	.64
1X2	.85	6BE6	.45	6SN7	.55	12SK7	.45
3V4	.75	6BG6	1.24	6SQ7	.55	12SN7	.56
5U4	.45	6B7A	1.13	6X4	1.25	6SO5	.50
5V4	1.28	6BL7	.90	6T8	.75	25BQ6	.30
5Y2	.65	6BN6	1.19	6V6	.55	25L6	.42
6AC7	.65	6BQ6	.90	6WA	.35	25W4	1.03
6A5	.45	6BQ7A	1.30	6X4	.40	35L6	.69
6AK5	.60	6C4	.35	6X5	.45	35W4	.50
6AL5	.40	6C6	.40	6X8	.45	3Z5	.55
6AQ5	.45	6CD6	1.08	12AT6	.40	50B5	.70
6AT6	.40	6CF6	1.25	12AT7	.65	50C5	.55
6AU4	.95	6CA6	1.13	12AU6	.65	50E5	.52
6AU5	1.10	6J5	.40	12AU7	.50	75	.85
6AUG	.45	6J6	.45	12AX4	1.29	83V	1.22

1000'S OF OTHER TUBES IN STOCK, WRITE

**FINEST HI-FI RECORDING TAPE**  
7 1/2" REEL—1200 FT PER REEL

**\$ \$ \$ Back Guarantee**  
Precision Coated & Silt, Gtd Splice  
Phase, Quality Controlled, Plastic Base,  
Gtd Constant Output, Freq. 7 1/2 IPS  
40-15 KC Oxide Wnd In.  
Sold Singly . . . \$1.80 Twelve Lot Special, ea. \$1.58

WRITE FOR NEW BONUS HI-FI GRAM

**"TAB" HI-FI SPEAKERS**

Inbuilt network, 2 wires needed for HF & LF Response. Famous HIFI mfrs.  
Model P25C0 15" Coaxial PM & 5" Tweeter  
25 Watt/20-17500 cycles . . . . \$19.50  
Model P12C0 12" Coaxial PM & 3 1/2" Tweeter  
12W/45-15000 cy. \$12.75; 3/\$35  
Model P8C0 8" Coaxial PM & 1 1/2" Tweeter  
8 Watt/70-15K. . . . . \$7.95; 2/\$15



**NEW GE PHONO CARTRIDGES**  
\*GE Original Boxed, \$ \$ \$ Back Gtd

RPX050A*	.001 & .003 (SS)	. . . . . \$ 6.98
RPX052A*	Golden Treasure (DS)	. . . . . \$19.98
RPX053A*	Golden Treasure (DD)	. . . . . \$28.98
RPX040A*	.003 Single (S)	. . . . . \$ 5.25
RPX041A*	.001 Single (S)	. . . . . \$ 5.25
RPJ010A	Replacement Tapes, "Tetrad" Diamond	. . . . . \$ 1.98
RPJ012A	Dual (S) .001 & .003 GE	. . . . . \$ 1.98
RPJ013A	Dual (D) .001 & .003 "Tetrad"†	. . . . . \$18.99
RPJ013A	Dual (DS) .001 & .003 "Tetrad"†	. . . . . \$10.99
Replacements for New A Cartridge Only		
RPJ01D	or RPJ03D Single (D) "Tetrad"†	. . . . . \$9.99
RPJ01S	or RPJ03S Single (S)	. . . . . \$11.35
Replacement Stylus for RPX040 & 041 Only		
RPJ001	or RPJ005 Single (S) GE	. . . . . \$1.35
RPJ003	or RPJ004 Single (D) "Tetrad"†	. . . . . \$9.99

**"TAB" TERMS:** Money Back Gtd (cost of mds only). \$5 min. order F.O.B. N.Y.C. chgd shpg. chgd charges or for C.O.D. 25% Dep. Tubes gtd. via R.Exp. Only. Prices shown subject to change.

111 LIBERTY ST., N.Y. 6, N.Y. RECTOR 2-6245  
DEPT. IRN6—CABLE "TABPARTS"

While every precaution is taken to insure accuracy, we cannot guarantee against the possibility of an occasional change or omission in the preparation of this index.

ADVERTISER	PAGE	ADVERTISER	PAGE
A. L. Products Co., Inc.	153	Major Brand Tube Co.	137
Aaron Electronics	142	Mallory & Co., Inc., P. R.	73, Fourth Cover
Airex Radio Corp.	155	Marantz Company	130
Allied Radio Corp.	9, 95, 96, 97, 98, 99,	Merit Coil & Transformer Company	104
Almo Radio Co.	163	Milwaukee School of Engineering	126
American Television & Radio Co.	134	Moss Electronic Distributing Co., Inc.	106, 107
Arky Radio Kits, Inc.	119	Music-Appreciation Records	7
Arrow Sales, Inc.	159	Musical Masterpiece Society, The	118
Ashe Radio Company, Walter	11	National Electronics of Cleveland	140
Audel, Publishers	149	National Radio Institute	3, 19, 20
Audiocraft Magazine	117	National Schools	27
Audio Unlimited, Inc.	162	Newark Electric Company	140
B & K Manufacturing Co.	109	Nuclear Products Co.	156
Baltimore Technical Institute	128	Olson Radio Warehouse	26
Bell Telephone Laboratories	31, 124	Orradio Industries, Inc.	118
Berlant-Concertone	136	Pacific State University	124
Bionder-Tongue Laboratories, Inc.	103	Peak Electronics Co.	130
Browning Laboratories, Inc.	163	Perfection Mica Company	87
Burstein-Appleebee Co.	153	Pilot Radio Corp.	72
CBS-Hytron	21	Post Electronics Company	146
Cabinart	6	Precise Development Corp.	159
Candler System Co.	109	Precision Apparatus Co., Inc.	146
Capital Electronics	155	Precision Electronics, Inc.	118
Capitol Radio Engineering Institute	29	Premier TV Radio Supply	150
Centralab	32	Prentice-Hall, Inc.	94
Century Electronics Co.	148	Progressive "Edu-Kits," Inc.	132
Channel Master Corp.	14, 15	R.C.A. Institutes, Inc.	25, 147
Cleveland Institute of Radio Electronics	101, 102	R-Columbia Products Co., Inc.	162
Columbia Electronics	144	RW Electronics	139
Commissioned Electronics, Inc.	158	Radiart Corp., The	24
Concord Radio Corp.	166	Radio Corporation of America	34
Conrad-Dubilier	24	Radio Products Co.	109
Coyne Electrical School	119	Radio-Television Training Association	23
Crown Controls Co., Inc.	133	Rad-Tel Tube Co.	152
DeVry Technical Institute	5	Rauland-Borg Corporation	120
Douglas Instrument Laboratory	119	Raytheon Manufacturing Company, 2nd Cover	154
Dressner	152	Rex Radio Supply Co.	154
Dynamic Electronics—New York, Inc.	158	Rider Publisher, Inc., John F.	16
Editors and Engineers Ltd.	143	Rinehart & Company, Inc.	12, 13
Electronic Chemical Corp.	145	River-Edge Sales Corp.	90
Electronic Instrument Co., Inc. (EICO)	36, 121, 125, 144, 149, 151, 153, 157, 162	Rockbar Corporation	110
Electrosonic	124	Ronette Acoustical Corp.	128
Electro-Voice, Inc.	8	Sams & Co., Inc., Howard W.	10
Elektra Products	160	Sangamo Electric Company	122, 123
E-Z Way Towers, Inc.	134	Science Kits	146
Fairchild Recording Equipment Co.	30	Scott, H. H.	111
Fair Radio Sales	127	Service Instruments Co.	150
Federated Television Mart, Incorporated	156	Shure Brothers, Inc.	100
Fisher Radio Corp.	91, 92, 93	Solar Electronics	135
G & G Radio Supply Co.	71	Sonotone Corporation	18
General Electric	28	Sprague Products Co.	154, 158, 162
Globe Electronics	138, 119	Spraberry Academy of Radio	152, 33
Goodheart, R. E.	155	Stan-Burn Radio and Electronics Co.	156
Greenlee	115	Standard Electrical Products Co.	138
Harjo Sales Co.	144	Stanley Electronics Corp.	117
Harvey Radio Company, Inc.	105	Stephens Manufacturing Corporation	121
Heath Company	75, 76, 77, 78, 79, 80, 81, 82, 83, 84, 85, 86	Stevens Walden, Inc.	108
Henry Radio Stores	131	Superior Instruments Co.	163
Hershel Radio Co.	138	Supreme Publications	115
Hi-Lite Electronic Sales Co.	114	"TAB"	164
Holloway Electronics Corp.	17	Telemarine Communications Co.	129
Hughes Research and Development Laboratories	141	Teletest Instrument Corp.	108
Indiana Technical College	159	Teltron Electric Company	161
Instructograph Company	162	Texas Crystals	148
International Radio & Electronics Corp.	151	Todd-Tran Corp.	134
J. J. Glass Electronics Co.	161	Transvision, Inc.	114
Jackson	74	Triad Transformer Corp.	165
Kuhn Electronic Products	148	Triplett Electrical Instrument Co., 3rd Cover	161
Lafayette Radio	22	Tri-State College	161
Lampkin Laboratories, Inc.	124	Tube Mart	125
Leotron Distributors	150	Tung-Sol Electric, Inc.	116
Leotron Specialists	154	U.S. Crystals, Inc.	158
Leotone Radio Corp.	121	United Catalogue Publishers, Inc.	109, 137, 147
Lytton Distributing Co.	121	United Radio Co.	147
L. M. B. Box Chassis	154	Universal TV School	157
McGee Radio Company	112, 113	University Loudspeakers, Inc.	149
McGraw-Hill Book Co.	140	Valparaiso Technical Institute	155
McIntosh Laboratory, Inc.	147	Viking of Minneapolis	157
M. R. Company, The	143	Weller Electric Corp.	145
		Wendell Plastic Fabrics Corp.	151
		Western Television Institute	143
		Wheatland Tube Company	90
		World Radio Laboratories	133



# Classified

RATE: 50¢ per word. Minimum 10 words. March issue closes January 11th. Send order and remittance to: RADIO & TELEVISION NEWS, 366 Madison Ave., N. Y. C. 17.

## RADIO ENGINEERING

COMPLETE radio, electronics theory & practice; television; broadcasting; servicing; aviation, marine, police radio. 18 or 21 months. Catalog. Valparaiso Technical Institute, Dept. N, Valparaiso, Ind.

## FOR SALE

CODE Oscillators Guaranteed. \$4.00 Postpaid, or C.O.D. Details Free. Stout, 2241 E. Broadway, Muskegon, Michigan.

TRADE-IN Television Sets \$14. Jones Radio, 1115 Rambler, Pottstown, Pa.

DIAGRAMS—Radio \$1.00; record changers, recorders \$1.25. Television with service data \$2.00. Where model unknown, give part numbers. Kramer's Radio Service, Dept. JA5, 36 Columbus Ave., New York 23, N. Y.

TAPE Recorders, Tapes, Accessories. Unusual Values. Dressner, Box 66R, Peter Stuyvesant Station, N. Y. 9.

BC-348P RECEIVER, brand new, original carton, covers 6 bands, 200-500 kc., 1.5-18 mc. Designed for 28 v.d.c., easily converted to 117 v.a.c. \$75.00 f.o.b., New York. Box 51, % RADIO & TELEVISION NEWS.

DIAGRAMS for repairing radios \$1.00. Television \$2.00. Give make, model. Diagram Service, Box 672-RN, Hartford 1, Conn.

TV Trade-In sets. Philco, R.C.A., Emerson, others. List available. 10"—\$17. 12" to 17"—\$20. up. Washtek Service Co., Dept. R, 956 Southern Blvd., Bronx, N. Y.

NEW stock of Tung-Sol 6550 Audio Tubes \$4.35 each, plus postage. Spera Electronic Supply, 37-10 33rd Street, L. I. C., N. Y.

SURPLUS Radios, Receivers, Electronic Equipment—Buy Direct from Government, Bulletin \$1.00. Box 1842U, Hartford 1, Conn.

FOR Sale—Complete T.V. Laboratory and library, tubes and books. Send for complete inventory. F. J. Stephens, Hollister, Mo.

HI-FIDELITY Specials: Collaro RC-54, Ronette Flip Cartridge, Mounting Board—\$38.75 Prepaid. Monarch of England, Top Quality 4 pole Motor Changer, GE RPX-050—\$38.75 Prepaid. Any Diamond Stylus, \$13.75, Boxed, Year Warranty. LP Records, Fresh, Sealed RCA, Columbia, all brands. 20% Off, Prepaid, Send List. Our Best Buy Hi-Fi System—\$225.50 Prepaid. Write for Details. Fidelity Unlimited, 63-03 39th Avenue, Woodside 77, N. Y. Latest Webcor Changer-Flip Astatic Cartridge, \$26.75 prepaid.

TELEVISION Trade-ins. 12 to 17. \$19 up. Byron Bros., RD2, Sinking Spring, Pa.

TUBE Bargains—\$65—\$1.00, 615 (vt 235)—35¢, 7193—35¢. All Tubes Guaranteed New. Send Money order, Postage Free. Stern & Kaufman, 718 New Market Street, Philadelphia 23, Pa.

SCINTILLATION Crystals. NE-101 Plastic Phosphors at new low cost, with instructions for use. Scintillation counter circuit \$1. Uranium Yearbook \$2. Geiger tubes only \$5. Geiger counters \$37.50 to \$545. Scintillation counters \$289 to \$3500. Ultraviolet lamps, Metal detectors. Western Radiation Laboratory, 1107 West 24th Street, Los Angeles 7, California.

TUBES—TV, Radio, Transmitting And Industrial Types At Sensibly Low Prices. New, Guaranteed, 1st Quality, Top Name Brands Only. Write For Free Catalog or Call Walker 5-7000, Barry Electronics Corp., 512 Broadway, New York 12N, N. Y.

RECORDERS, Hi-Fi, lowest prices. Free catalogue. Klarston, 215 E. 88, New York 28.

MANUFACTURERS Surplus. Build your own Electronic Organ from these basic units: 60 note triple stacked shunt keying mechanisms, octave wired isolating resistor to each palladium contact. Three types available: Great 16', 8', 4' dimensions 5" wide, 2 1/2" high, 36" long; Swell 8', 4' 2 1/2" dimensions 3 1/2" wide, 3 1/4" high, 36" long; Single Manual 16', 8', 4' including 12 pedal bass notes dimensions 4" wide, 3" high, 36" long; keying mechanisms—\$10.00 each. Tone generator sub-assemblies consisting of 21, 400V and 600V capacitors and 15 resistors. \$.50 each. Box 549, % RADIO & TELEVISION NEWS.

TV-FM antennas. All types including UHF. Mounts, Accessories. Lowest prices. Wholesale Supply Co., Dept. H, Lunenburg, Mass.

## WANTED

WANTED—Electronic Tubes, all types. Also want all types airborne electronic equipment: ART-13; BC-788; I-152; ARC-1; ARN-7, etc. Top dollar paid! Bob Snett, W6REX, 1524 S. Edris Dr., Los Angeles 35, California.

CYLINDER and old disc phonographs. Edison Concert, Balmoral, Conqueror, Opera, and Oratorio models. Berliner Gramophones and Zonophones, Columbia disc and cylinder Graphophones, Bettini micro-reproducer. Want old catalogues and literature on early phonos prior to 1919. Will pay cash or trade late hi-fi components. Box 50 % RADIO & TELEVISION NEWS.

AN/APR-4, AN/APR-9, other "APR-," "ARR-," "TS-," ARC-1, ARC-3, ART-13, everything surplus; Tubes, Manuals, Laboratory equipment. Describe, price in first letter. Engineering Associates, 434 Patterson Rd., Dayton 9, Ohio.

WILL Buy All ART-13 T47A Transmitters \$200.00. ART-13 T47 Tansmitters \$150.00. BC-788C Altimeters \$160.00. ARC-3 Complete \$185.00. R5/ARN-7 Radio Compass \$175.00. BC-348 Rec'r Modified \$25.00. BC-348 Rec'r Unmodified \$50.00. ARC-1 Radio Complete \$250.00. BC-312 Receiver \$40.00. BC-342 Receiver \$50.00. Ship via Express C.O.D. Subject to Inspection to: H. Finnegan, 49 Washington Ave., Little Ferry, N. J.

WANTED—ART-13 transmitters, parts, and components, DY-12 and DY-17 dynamotors, CU-25, etc. Also ARC-1 and ARN-7 material. Advise price condition first letter. Florida Aircraft Radio & Marine, Inc., P. O. Box 205, International Airport Branch, Miami 48, Florida.

WANTED Receiver R5/ARN-7, Transceiver RT18/ARC-1, MN-61-A, AN/ARC-3, Dynamotors, Test Equipment, Receivers, Transmitters. We Pay The Very Highest Prices. Send full information including quantity, condition, price first letter. Aircraft Radio Industries, Inc., 15 East 40th St., New York City, Telephone Lexington 2-6254.

TUBES and equipment bought, sold, and exchanged. For action and a fair deal write B. F. Gensler, W2LNI, 56 Crosby St., N. Y. 12N, N. Y.

CASH for BC-610E, BC-614E, BC-939, BC-729, BC-221, BC-312, 348, TCS, AN/GRC-9 and higher, and parts for all these. Amber Industrial Corporation, Surplus Div., 75 Varick Street, N. Y.

## REPAIRS AND SERVICING

HIGH Fidelity Speakers Repaired. Amprite Speaker Service, 70 Vesey St., New York 7, N. Y. Ba. 7-2580.

## HELP WANTED

TELEVISION Jobs—Names and addresses of companies to contact. \$1.00. Fitzgerald, (Chicago Division), Dept. A-14, 815 Countryside Drive, Wheaton, Illinois.

## BUSINESS OPPORTUNITIES

BUY Wholesale, 25,000 Items, Catalog 25c. Matthews, 1472-R4 Broadway, NYC 36.

## CORRESPONDENCE COURSES

USED Correspondence Courses and Books sold and rented. Money back guarantee. Catalog free. (Courses bought.) Lee Mountain, Pisgah, Ala.

RADAR—Correspondence course, including Loran, Sonar and Microwave, now being offered. Inquire Progressive Electronics Institute, P. O. Box 27764, Los Feliz Station, Los Angeles 27, Calif.

## INSTRUCTION

ENGINEERING Degrees Earned Through Home Study. American College of Engineering. Box 27724 (K), Hollywood 27, Calif.

## RECORDS

PHONOGRAPH Records Cheap. Catalogue. Paramount, NA—313 East Market, Wilkes-Barre, Penna.

## MISCELLANEOUS

BECOME a Radio Amateur. Free Information on how to pass Code and Theory FCC examinations. American Electronics, 1203 R. Bryant Ave., New York 59.



more new  
\*correct  
replacement  
flybacks

(Horizontal Output Transformers)

by TRIAD

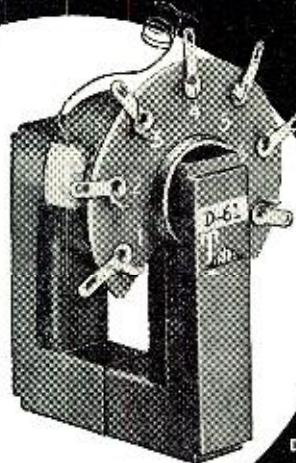

TRIAD  
D-61 Sylvania  
\*Correct  
Replacement

D-61 List Price \$7.25 correct replacement for Sylvania Part 241-0003

D-62 List Price \$7.75 correct replacement for Sylvania Part 241-0005, 241-0006

D-63 List Price \$8.20 correct replacement for Sylvania Part 241-0007

TRIAD \*Correct Replacement flybacks are mechanically and electrically correct ruggedized versions of manufacturer's items — and wherever possible COMPOSITE REPLACEMENT to fill a number of requirements where mechanical and electrical specifications are identical.

All items are listed in Sams Photofact Folders and Counter Facts.

Write for catalog IV—155A



4055 Redwood Ave. • Venice, Calif.



When you order by mail . . .

please print your name and address clearly, be specific in your order, enclose proper amount, allow ample time for delivery.



# Concord MONEY SAVING VALUES

## 15 WATT HIGH FIDELITY AMPLIFIER

- Built-in Pre-amp
- 4 Inputs

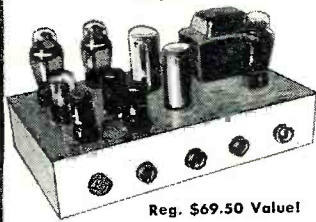

Reg. \$69.50 Value!

\$24.50  
Kit Form

\$29.50  
Wired

Superb mirror-like reproduction at an absolutely unbelievable price! Concord's "CELEBRATION" Amplifier has a frequency response of 20 to 20,000 cycles Push-pull 6L6's give a full 15 watts of undistorted (less than 1%) power. Seven tube circuit uses 2-6J5's to give 40 db bass boost attenuation range, and 30 db treble boost-attenuation range. Noise level is better than 50 db below rated output. Other tubes include 6SQ7 pre-amplifier, 6SN7 phase inverter and 5Y3 rectifier. Controls include mike volume, phono volume, bass control, treble control and function selector. Output transformer will drive 8 ohm speaker. Adjustable hum balance control assures minimum hum as tubes age. Chassis is finished in grey vitreous enamel. Size 14" L x 8" D x 7 1/4" H. For 110-125 V. 60 cycle AC. Shpg. wt. 18 lbs. Complete with tubes. Kit includes all necessary components, complete pictorial step-by-step instructions and tubes. Less wire and solder.

Stock No. K-CA15K. 15 Watt Kit. Only \$24.50  
Concord's "CELEBRATION" Amplifier described above, completely wired. Stock No. K-CA15W. Worth \$69.50. Only \$29.50

## DELCO 8 TUBE-PUSH BUTTON AUTOMOBILE RADIO

Will outperform any Auto Radio on the market today!

Reg \$125.00



Now \$29.95

Complete with 9 section 82" solid brass whip antenna. Measures only 14" collapsed. Worth \$9.20

Here's the auto radio with all the excellent features every car owner wants in his auto. Covers full broadcast range with powerful 10 watt push-pull output. Has 5 push-buttons and a sensitivity control in addition to manual tuning! Selective 8 tube circuit includes 2-6SK7's, 2-6V6's, 1-6SQ7, 1-6SA7, and 1-02A. Large 6"x8" speaker, push-pull output, and wide range tone control guarantee that this radio will outperform any competitive model on the market. It's ideal for tractors, trucks, boats and vacation camps as well as your automobile. . . . truly the finest money can buy. Size: 9" high x 10" wide x 7 1/4" deep. Control shaft centers are 6-11/16" apart and require 1/2" diameter holes. Shpg. wt. 19 lbs. Complete with owners' installation manual, all necessary hardware, brackets and knobs. With tubes. Less escutcheon.

Stock No. 99-PBT. . . . . Reg. \$125.00. . . . . Only \$29.95

## HIGH FIDELITY COAXIAL SPEAKERS

Worth \$19.90



These superb instruments are built especially for Concord by one of the leading audio manufacturers in the country. Acoustically designed for finest reproduction, quality built into every component for years of enjoyable performance. Sold at prices that are really exceptionally low! All of these fine speakers have remarkable power handling capacity with lowest distortion. One piece molded cones in both woofer and tweeter. Has "cross-over" network. Response uniform 50-13,000 cps. Speakers use extremely heavy Alnico magnets



## FAMOUS BRAND 25 WATT 12" HI-FI SPEAKER

Highly recommended hi-fi 12" speaker with 9 oz. Alnico V magnet. Powerful 25 watt rating and freq. response of 50 to 12,000 cycles make this the best speaker buy available. Ideal for PA work where power and fidelity are a must. Voice coil impedance 6-8 ohms. Will perform at full rated power without significant loss of bass or treble or distortion. Precision engineering and superior materials put this speaker in a class by itself.

Reg. \$19.95  
Only \$7.50 ea.

3 for \$20.85

## PM SPEAKER VALUES

Class "A" replacement speakers at Bargain Basement prices. All have heavy Alnico V magnets and are constructed to give a lifetime of trouble-free performance. Stock up now while the supply lasts!



Size	Price Ea.	Price Ea. Lots of 3
4"	\$1.55	\$4.45
5"	\$1.65	\$4.55
6"	\$2.15	\$5.05
4"x6"	\$2.05	\$5.95
5"x7"	\$2.35	\$6.20
6"x9"	\$3.10	\$7.95
8"	\$3.30	\$8.15
12"	\$4.90	\$14.65

## SPECIAL BUY—8" and 10" PHILCO SPEAKERS

Complete With 50L8 Output Transformer and AC-DC Choke Mounted on Frame! Extra Heavy Alnico V Magnets.

8"—\$2.95 ea.—3 for \$8.50  
10"—\$3.49 ea.—3 for \$9.95

## ELECTRO-DYNAMIC SPEAKERS

Made for Philco. Individually boxed. Excellent frequency response and power output. Ideal for replacement use or original equipment design.

4"	3000 Ohm	79c	6"	2500 Ohm	\$1.05
5"	4 Ohm	79c	8"	1700 Ohm	\$1.15
5"	2500 Ohm	89c	8"	2500 Ohm	\$1.25
4x6	450 Ohm	88c	10"	1700 Ohm	\$1.49
6"	1700 Ohm	\$1.05	10"	2500 Ohm	\$1.49

## DIAMOND STYLI SALE

Famous Brand Diamond Stylis designed to fit into new GE Reluctance Cartridge RFX-050A or old RFX-050. Replacement for GE #RPJ-013A. Has individually replaceable slide-in stylus. Diamond and Sapphire.

Reg. \$31.00. . . . . Only \$11.95 ea.  
New Slide-in type diamond stylus for RFX-041A or RFX-040. Complete assembly. List \$27.50. . . . . \$10.95 ea.

## INDOOR TV ANTENNAS 6 for \$1.00

Unmatched Value! Expertly designed indoor TV antennas attach in seconds. Mount invisibly on back of TV set. No unsightly rabbit ears or wings to spoil the appearance of the room. And what's more, they work! Buy them by the dozen and solve many of your TV antenna problems.

## MOBILE WHIP ANTENNA Only \$1.98 ea.

One of the most sensational Whip Antennas ever offered. 9 section solid brass construction. 82" fully extended, only 14" collapsed. Can be adapted to a hundred different uses. Designed originally for bumper mounting with a removable base clamp. Can be used on 2, 6, 10 or 11 meters. Removable mast makes it possible to base load this antenna for 20, 40 or 75 meters. Simplified construction makes it possible to use 6 of the whips as a low priced beam antenna, or 4 as a ground plane.  
Stock No. R-AN75D. . . . . 3 for \$5.45

## BUILD YOUR OWN SPECTROSCOPE

### INFRA-RED SPECTROSCOPE TUBE AND FILTER

Reg. \$39.50  
Only \$7.95

Now you can see in the dark with this ingenious infra-red viewing device. Made famous by Armed Forces during World War II. Simple to construct with parts easily obtained. Spectroscope tube and filter supplied are the only specialized parts required. Complete with instructions schematic and information sheet. Stock No. SCR124



## GERMANIUM DIODE KIT

10 for \$3.45 Worth \$12.50

Here's a sensational kit value that has never been offered before. An assortment of 10 of the most modern and widely used germanium diodes. Complete with their specifications and interchangeability chart. Included are such currently used TV numbers as 1N34A, 1N87A, 1N51A, 1N56A, 1N38A and the latest GoldBond diodes TSS, TSS3, and TSI. The retail value of these brand new, famous brand diodes is over \$12.50. Order several kits to be sure of an adequate supply.

Stock No. R-GDK10. . . . . \$3.45

## FILTER CHOKE VALUES

TV REPLACEMENT CHOKE—2.5 henry at 150 MA. 60 ohms DC Res. Size 2" L x 3 1/4" x 2". Mtg. Ctrs. 2 3/4" apart. Stock No. R-25F6. . . . . \$3.45  
5% ea.—3 for \$1.59

25) MA SWINGING CHOKE—Rated at 4.5 henrys at 250 MA to 8.5 henrys at 50 MA. DC Res. 150 ohms. Open frame mount. Size 3" L x 2" W. Mtg. Ctrs. 3-3/16" apart. Stock No. R-SWK45. . . . . \$3.45  
6% ea.—3 for \$1.95

JEFFERSON DUAL CHOKE—Two separate 8 henry 80 MA chokes in one case. JAN spec. Hermetically sealed. 6" H. x 3 1/2" x 3". Worth \$10.00. Stock No. R-004105. . . . . \$1.49 ea.—3 for \$3.95



## TV POWER TRANSFORMER SPECIAL

Worth \$17.25  
Only \$4.95

All outstanding power transformer value. 350-0-350 volts at 25) MA. 5 Volts at 6 Amps, 6.3 Volts at 6 Amps, and 6.3 Volts at 1.2 Amps. Size 4 1/2" x 3 3/4" x 4 3/4" Mtg. Ctrs. 3" x 3 3/4". Shpg. wt. 11 lbs.  
Stock No. R-TVP15. . . . . \$4.95

## 6.3 VOLT FILAMENT TRANSFORMER

6.3 V @ 1 Amp. \$1.19 Ea.  
Worth \$2.95  
JAN SPECS 3 for \$2.95

## TUBE SPECIALS

FAMOUS BRAND—GUARANTEED  
304TH—\$3.95 ea. 304TL—\$7.95 ea.  
616's—6 for \$3.00 65N7—5 for \$3.00  
Send for Bargain Tube Sheet No. 114—  
Thousand of Fabulous Tube Values!

## HEAVY DUTY DUAL BLOWER

BLOWS HOT OR COLD!!  
WORTH \$29.50  
Only \$14.95



Made by famous manufacturer. Has AC shaded pole motor, dual multi blade fans and dual outlet blowers. Heating elements are built into each blower outlet. 3 way switch blows hot or cool air. Has UL approved line cord. Operates at 2800 rpm. 2850 fpm velocity. Has a million uses, photo dark rooms, cooling xmtr tubes, humidifiers, hair dryers, kitchen ventilators, etc. Black lacquer finish, wt. 11 lbs. 8 1/4" long x 6" H. Vent openings 2" diam. Stock No. R-5107B.

## LATEST SARKES TARZIAN CASCODE VHF TUNER

Another exceptional tuner value from Concord. Latest 3 tube Sarkes Tarzian Cascode tuners for less than manufacturer's cost! Covers all 13 VHF channels with unusually high sensitivity and low co-channel interference. Designed to last a lifetime and give terrific fringe area reception. Ideal low cost replacement unit. Guaranteed Brand New and in excellent operating condition. Available for either 21 or 11 megacycle use. Please specify.

Stock No. R-STD-3. . . . . \$8.95 ea.

## KIT OF USED SARKES TARZIAN TUNERS IDEAL FOR EXPERIMENTING OR REPLACEMENT PARTS. LESS TUBES. 3 for \$1.98

## WESTINGHOUSE UHF TUNERS

CONVERT TO UHF For Only \$1.95 Worth \$24.95

It's Fabulous! The opportunity of a lifetime. Now you can convert to UHF for only \$1.95. Sensational Westinghouse UHF Tuners are designed to operate in conjunction with your present VHF tuner to give you complete ALL-CHANNEL coverage. Tunes 450 to 870 Mc. Output 43 Mc. Regular 300 ohm input. The ideal basic element for building tuner converter, booster or for experimenting on UHF. Convenient size for installation in TV chassis. (5 x 2 1/2 x 5"). Complete with 6AF4 and crystal easy-to-follow schematic. Shpg. wt. 2 lbs.  
Stock No. 99-G-V11390

## WESTINGHOUSE UHF RECEPTOR

Complete with 6AF4 Tube, Crystal Diode, Schematic and Instructions

What more can we say! You get this highly miniaturized UHF receptor complete with tube, germanium diode, resistors, condensers, coils, variable condenser, plug and socket. ALL FOR LESS THAN THE PRICE OF THE TUBE ALONE!! In addition we throw in a schematic diagram and installation instructions. Quantities are limited, so buy now and save!!  
Stock No. WTC-2. . . . . \$1.25 ea.



FAMOUS CROSLY UHF TUNERS  
Only \$4.95 ea.  
\$4.45 ea. Lots of 3

Worth \$29.50 in Parts Alone!

Uses famous Mallory continuous tuning inductor. Covers all UHF channels 14 thru 82. Original replacement for Crosley part 154699-1-1 used in Crosley series EU chassis 393 and 394. Ideal for building UHF converters, etc. Output feeds into channel 5 I.F. Concentric shaft includes fine tuning. Built-in antenna switch operates off tuning shaft. Comes complete with 1N72 diode, 6BZ7 and shock mounted 6AF4 tubes. Size: 8 x 5 x 3 1/4". Shpg. wt. 5 lbs.  
Stock No. R-CMD15. . . . . \$4.95 ea.

## REPLACEMENT PHONO MOTORS

Only \$1.49 ea.—3 for \$4.15

Worth \$4.50

- Limited Quantity Available
- Single Speed 78 RPM
- Rim Drive—Brand New

All Merchandise Money Back Guaranteed. \$5.00 Minimum Order. F.O.B. N.Y.C. 25% Deposit for C.O.D.'s—Prices subject to change without notice.

## SEND FOR FREE CATALOG

CONCORD RADIO Dept. N16  
45 Warren Street, N. Y. 7, N. Y.  
Please, send me your Special Bargain Catalog free of charge.

Name

Address

City

State



No one piece of equipment can do more for you. As the electronic field expands your tube tester must do more. TRIPLETT TUBE TESTERS meet this demand. More heater voltages including 3.15, 4.2 and 4.7 volts for 600 mill series string heaters. Quickly locating the bad tubes saves time. Tube sales can be a profitable business in itself.

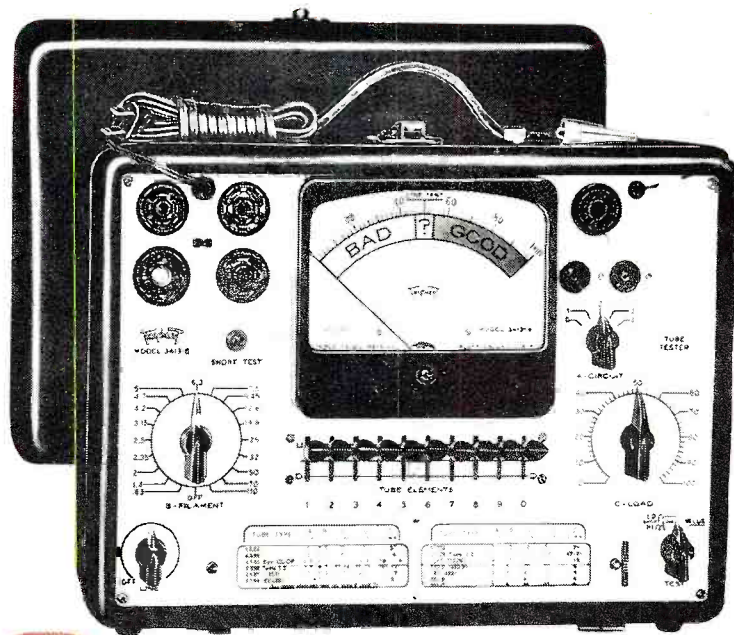

# 80% OF YOUR SERVICE JOBS CAN BE COMPLETED WITH A **TRIPLETT TUBE TESTER**

**NEW  
UNIQUE  
AND ONLY \$79.50**

*The first  
low priced  
tube tester  
to provide*

**DUAL SENSITIVITY  
SHORT TEST**

*Triplet model 3413-B combines provision for conventional short test (0.25 megohms) with high sensitivity leakage test (2.0 megohms)—will test series string tubes without adapter.*

Model 3413-B is a money-saver on original cost—a profit maker because it's faster, more versatile, more flexible operation for more tests in less time. This tester does a better job today and tomorrow—and here's why:

- ☞ New, longer roll chart includes all tubes up to the moment.
- ☞ Triplet automatically furnishes revised, up-to-date roll charts regularly if you promptly return registration card. (Included with tester.)
- ☞ Flexibility of switching allows you to set up to test *any new tube*.
- ☞ Tests TV picture tube by means of BV Adapter (\$4.50) without removing tube from set.
- ☞ Reads BAD—?—GOOD direct on big 6-inch meter.
- ☞ Short tests (neon) each element with single flip of switch.

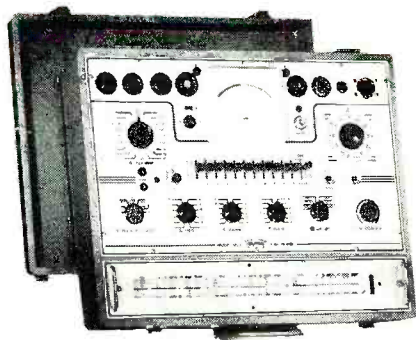

*And for the ultimate in laboratory quality testing examine*  
**MODEL 3423 MUTUAL CONDUCTANCE TUBE TESTER \$199.50**

Proportional Mutual Conductance testing of *all* radio and TV tubes plus selenium rectifiers, crystal diodes, pilot lamps, thyratrons, transistors, etc., by a new patented circuit.

*At leading Parts Distributors everywhere,  
see the fines and most complete line of test equipment by*

# TRIPLET

**ELECTRICAL INSTRUMENT COMPANY**  
BLUFFTON, OHIO



... Another  
**MALLORY**  
service engineered  
product

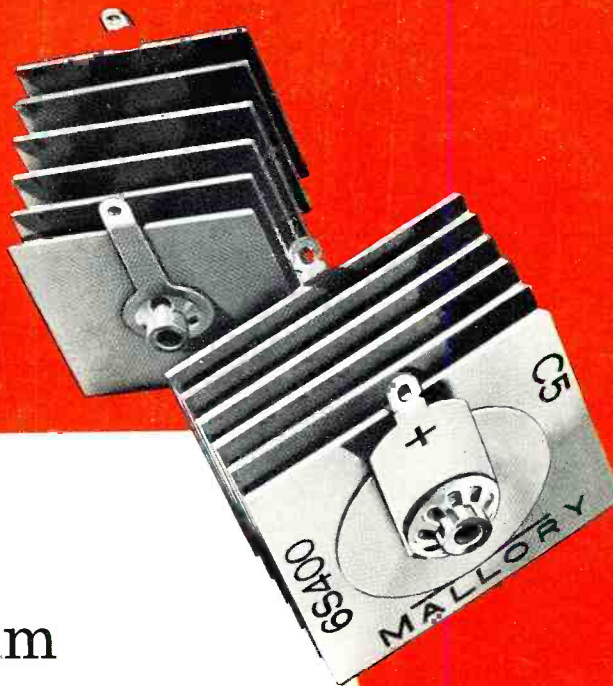

## Mallory Selenium Rectifiers

make every  
replacement sure

Made by Mallory-developed techniques unique in the industry, this new line of selenium rectifiers gives you an unequalled combination of performance and dependability.

**SERVICE LIFE IS LONG**—far exceeds original equipment specifications.

**EFFICIENCY IS HIGH** due to low forward voltage drop. Efficiency stays high throughout service life.

**COUNT ON EVERY STACK** for the same high quality. The new rectifiers are manufactured to standards of uniformity never before possible.

**RATINGS ARE CONSERVATIVE**—no need to use over-size stacks to “play safe”. Order your stock today from your Mallory distributor.

P. R. MALLORY & CO. Inc.  
**MALLORY**

P. R. MALLORY & CO. Inc., INDIANAPOLIS 6, INDIANA

• Capacitors • Vibrators • Resistors • Controls • Switches  
• Rectifiers • Power Supplies • Filters • Mercury Batteries